

# **User Manual**

## **SDS2000X Series Digital Oscilloscope**

**UM0102X-E02B**



# Copyright and Declaration

## Copyright

SIGLENT TECHNOLOGIES CO., LTD. All Rights Reserved.

## Trademark Information

**SIGLENT** is the registered trademark of **SIGLENT TECHNOLOGIES CO., LTD.**

## Declaration

**SIGLENT** products are protected by patent law in and outside of P.R.C.

**SIGLENT** reserves the right to modify or change parts of or all the specifications or pricing policies at company's sole decision.

Information in this publication replaces all previously corresponding material.

Any way of copying, extracting or translating the contents of this manual is not allowed without the permission of **SIGLENT**.

## Product Certification

**SIGLENT** guarantees this product conforms to the national and industrial standards in China and other international standards conformance certification is in progress.

## Contact Us

If you have any problem or requirement when using our products, please contact  
SIGLENT TECHNOLOGIES CO., LTD

Add: Blog No.4 & No.5, Antongda Industrial Zone, 3rd Liuxian Road, Bao'an District,  
Shenzhen, 518101, China.

Tel:400-878-0807

E-mail:sales@siglent.com

<http://www.siglent.com>

# Safety Information

## General Safety Summary

Carefully read the following safety precautions to avoid any personal injury or damage to the instrument and any products connected to it. To avoid potential hazards, please use the instrument as specified.

### Use Proper Power Cord

Only the power cord designed for the instrument and authorized by local country should be used.

### Ground the Instrument

The instrument is grounded through the protective earth conductor of the power cord. To avoid electric shock, please make sure the instrument is grounded correctly before connecting its input or output terminals.

### Connect the Signal Wire Correctly

The potential of the signal wire ground is equal to the earth, so do not connect the signal wire to a high voltage.

### Look Over All Terminals' Ratings

To avoid fire or electric shock, please look over all ratings and sign instruction of the instrument. Before connecting the instrument, please read the manual carefully to gain more information about the ratings.

### Use Proper Overvoltage Protection

Make sure that no overvoltage (such as that caused by a thunderstorm) can reach the product, or else the operator might expose to danger of electrical shock.

### Electrostatic Prevention

Operate in an electrostatic discharge protective area environment to avoid damages induced by static discharge. Always ground both the internal and external conductors of the cable to release static before connecting.

### Maintain Proper Ventilation

Inadequate ventilation may cause an increase of instrument's temperature, which may eventually damage the instrument. Maintain proper ventilation and inspect the intake and fan regularly.

### Avoid Exposed Circuits and Components

Do not touch exposed contacts or components when the power is on.

#### **Use Proper Fuse**

Use only the specified fuse.

#### **Do Not Operate Without Covers**

Do not operate the instrument with covers or panels removed.

#### **Do Not Operate With Suspected Failures.**

If you suspect damage has occurred to the instrument, have it inspected by qualified service personnel before further operation. Any maintenance, adjustment or replacement especially to circuits or accessories must be performed by **SIGLENT** authorized personnel.

#### **Do Not Operate in Wet Conditions.**

In order to avoid short circuiting to the interior of the device or electric shock, please do not operate in a humid environment.

#### **Do Not Operate in an Explosive Atmosphere.**

In order to avoid damage to the device or personal injury, it is important to operate the device away from an explosive atmosphere.

#### **Keep Product Surfaces Clean and Dry.**

To avoid the influence of dust and/or moisture in air, please keep the surface of device clean and dry.

#### **Handling Safety**

Please handle with care during transportation to avoid damage to buttons, knob interfaces and other parts on the panels.

## Safety Terms and Symbols

**Terms in this Manual.** These terms may appear in this manual:



---

**WARNING**

Warning statements indicate the conditions or practices that could result in injury or loss of life.

---



---

**CAUTION**

Caution statements indicate the conditions or practices that could result in damage to this product or other property.

---

**Terms used in this product.** These terms may appear in the product:

**DANGER** Indicates direct injury or hazards that may happen.

**WARNING** Indicates potential injury or hazards that may happen.

**CAUTION** Indicates potential damage to the instrument or other property that may happen.

**Symbols used in this product.** These symbols may appear on the product:



**Hazardous  
Voltage**



**Protective  
Earth Ground**



**Warning**



**Earth  
Ground**



**Power Switch**

---

## Measurement Category

### Measurement Categories

SDS2000X series digital oscilloscopes are rated for Category I measurements only.



---

#### **WARNING**

This oscilloscope can only be used for measurements within its specified measurement categories.

---

### Measurement Category Definitions

Measurement category I is for measurements performed on circuits that are not directly connected to MAINS. Examples are measurements on circuits not derived from MAINS, and specially protected (internal) MAINS derived circuits. In the latter case, transient stresses are variable; for that reason, the transient withstand capability of the equipment is made known to the user.

Measurement category II is for measurements performed on circuits directly connected to low voltage installations. Examples are measurements on household appliances, portable tools and similar equipment.

Measurement category III is for measurements performed in the building installation. Examples are measurements on distribution boards, circuit-breakers, wiring, including cables, bus-bars, junction boxes, switches, socket-outlets in the fixed installation, and equipment for industrial use and some other equipment, for example. Stationary motors with permanent connection to the fixed installation.

Measurement category IV is for measurements performed at the source of the low-voltage installation. Examples are electricity meters and measurements on primary over current protection devices and ripple control units.

## Working Environment

### Temperature

Operating: 10°C to +40°C

Non-operation: -20°C to +60°C

### Humidity

Operating: 85%RH, 40°C, 24 hours

Non-operating: 85%RH, 65°C, 24 hours



### **WARNING**

To avoid short circuit inside the instrument or electric shock, please do not operate in humid environment.

---

### Altitude

Operating: less than 3 km

Non-operation: less than 15 km

### Installation (Overvoltage) Category

This product is powered by mains conforming to installation (overvoltage) category II.



### **WARNING**

Make sure that no overvoltage (such as that caused by lightning) can reach the product or else the operator might be exposed to danger of electric shock.

---

### Installation (Overvoltage) Category Definitions

Installation (overvoltage) category I refers to signal level which is applicable to equipment measurement terminals connected to the source circuit. In these terminals, precautions should be made to limit the transient voltage to the corresponding low level.

Installation (overvoltage) category II refers to the local power distribution level which is applicable to equipment connected to the AC line (AC power).



---

## Ventilation Requirement

This oscilloscope uses fan-forced air cooling. Please make sure that the air intake and exhaust areas are free from obstructions and have adequate ventilation. When using the oscilloscope in a bench-top or rack setting, provide at least 10 cm clearance beside, above and behind the instrument for adequate ventilation.



---

### **WARNING**

Inadequate ventilation may cause temperature increase which would damage the instrument. So please keep the instrument well ventilated during operation and inspect the intake and fan regularly.

---

## General Care and Cleaning

### Care

Do not store or leave the instrument in direct sunshine for long periods of time.



**WARNING**

To avoid damage to the instrument or probes, please do not leave them in fog, liquid, or solvents.

---

### Cleaning

Please perform the following steps to clean the instrument and probe regularly according to its operating conditions.

1. Disconnect the instrument from all power sources and then clean it with a soft wet cloth.
2. Clean the loose dust on the outside of the instrument and probe with a soft cloth. When cleaning the LCD, take care to avoid scratching it.



**WARNING**

To avoid damage to the surface of the instrument and probe, please do not use any corrosive liquid or chemical cleanser.

---



**WARNING**

Make sure that the instrument is completely dry before restarting it to avoid short circuits or personal injury.

---

---

# Exigence de Sécurité

## Résumé de la sécurité en général

Lisez attentivement les consignes de sécurité suivantes pour éviter des blessures personnelles et endommager l'instrument ou tout autre produit qui y est connecté. Pour éviter de grands risques, veuillez utiliser l'instrument tel que spécifié.

### Utilisez une alimentation convenable

Utilisez uniquement la ligne d'alimentation spéciale qui est approuvée par l'état local.

### Mettez à la terre l'instrument

L'instrument est mis à la terre grâce au conducteur de protection de la ligne d'alimentation. Pour éviter un choc électrique, le conducteur de protection doit être relié à la terre. Assurez-vous que l'instrument est mis à la terre correctement avant de connecter ses bornes d'entrée ou de sortie.

### Branchez correctement le câble de signalisation

Le potentiel du câble de signalisation est égal à la terre, aussi, il ne faut pas connecter ce câble à une haute tension. Ne pas toucher les contacts ou les composants apparents.

### Jetez un coup d'œil à toutes les notes concernant les terminaux

Pour éviter un incendie ou tout choc électrique, veuillez bien prendre note de toutes les instructions et signaux de notation de l'instrument. Avant de brancher l'instrument, veuillez lire attentivement le manuel pour obtenir davantage d'informations concernant toutes les notations.

### Employez la protection appropriée de surtension

Assurez-vous qu'aucune surtension (comme cela provoqué par un orage) ne peut atteindre le produit, ou bien l'opérateur pourrait exposer au danger du choc électrique.

### Empêchement électrostatique

Fonctionnez dans un environnement protecteur de secteur de décharge électrostatique pour éviter des dommages induits par décharge statique. A toujours rectifié les conducteurs internes et externes du câble pour libérer la charge statique avant de se relier.

### La ventilation insatisfaisante de ventilation

bonne de subsistance peut causer l'augmentation de la température, qui endommagera par la suite l'instrument. Gardez ainsi la ventilation bonne et inspectez la prise et éventez régulièrement.

### Évitez le circuit ou les composants exposés

ne touchent pas les contacts ou les composants exposés quand le courant passe.

**Employez l'utilisation appropriée**

de fusible seulement le fusible indiqué.

**Ne pas faire fonctionner en cas de pannes suspectes**

Si vous pensez que l'instrument est endommagé, veuillez le faire vérifier par un personnel qualifié..

**Ne fonctionnez pas avec des échecs suspectés.**

Si vous suspectez les dommages se produisent à l'instrument, l'ont inspecté par le personnel de service qualifié avant d'autres opérations. N'importe quel entretien, ajustement ou remplacement particulièrement aux circuits ou aux accessoires doivent être exécutés par le personnel autorisé par **SIGLENT**.

**Ne pas utiliser dans un milieu humide.**

Afin d'éviter de court-circuiter à l'intérieur du dispositif ou de la décharge électrique, svp ne fonctionnez pas dans un environnement humide.

**Ne pas utiliser dans une atmosphère explosive.**

Afin d'éviter d'endommager le dispositif ou les blessures, il est important d'utiliser le dispositif loin à partir d'une atmosphère explosive.

**Garder la surface de l'appareil propre et sèche**

Pour éviter l'influence de la poussière et/ou de l'humidité en air, maintenez svp la surface du dispositif propre et sèche.

**En manipulant la sûreté**

manipulez svp avec soin pendant le transport pour éviter d'endommager des boutons, des interfaces de bouton et d'autres parties sur les panneaux.

Sondez seulement les ensembles qui répondent aux caractéristiques du fabricant seront employés.

Quand des sondes de l'utilisation 5X/10X/50X/100X/500X/1000X, les sondes seront isolées des circuits mesurés par le double ou l'isolation renforcée.

Toutes les sondes devraient répondre aux exigences de l'UL 61010-031 et du CAN/CS A-C22.2 No. 61010-031-07

Le corps ou l'opérateur responsable devrait se référer au manuel d'instruction pour préserver la protection se permettent par l'équipement. Si l'équipement est utilisé en quelque sorte non indiqué par le fabricant, la protection fournie par l'équipement peut être altérée.

On ne permet à aucune pièce du dispositif et de ses accessoires d'être changé ou remplacé, autre qu'autorisé par le fabricant ou son agent.

Pas placer l'équipement de sorte qu'il soit difficile d'utiliser le dispositif débranchant (prise détachable).

## Termes et symboles de sécurité

**Termes figurant sur le produit.** Sur le produit, on peut trouver les termes suivants :



**Attention**

signifie qu'il y a risque de grandes blessures ou de danger.  
Reportez-vous à cette fiche de sécurité, au manuel utilisateur et respectez les précautions d'emploi.



**Attention**

signifie qu'il y a risque de grands dangers pour l'instrument ou un autre bien. Reportez-vous à cette fiche de sécurité, au manuel utilisateur et respectez les précautions d'emploi.

**Limites sur le produit.** Ces limites peuvent apparaître sur le produit:

**DANGER:** signifie qu'il y a risque de blessures directes ou de danger.

**WARNING:** signifie qu'il y a risque de grandes blessures ou de danger.

**CAUTION:** signifie qu'il y a risque de grands dangers pour l'instrument ou un autre bien.

**Signification des principaux symboles qui peuvent être présents sur votre produit:**



**Danger  
Tension**



**Mise à la terre**



**Attention**



**Terre**



**Commutateur  
d'alimentation**

Si la trouvaille de tels symboles sur le produit, consultez le manuel pour découvrir la nature du risque et des actions qui doivent être pris.

## Définition des catégories de mesure

Les oscilloscopes peuvent faire des mesures dans d'autres circuits qui ne sont pas directement reliés aux forces.



---

### Attention

L'oscilloscope ne peut être utilisé que pour des mesures dans les catégories de mesure spécifiées.

Veillez ne pas utiliser le produit pour effectuer des mesures dans d'autres catégories de mesure, telles que CAT II, CAT III, CAT IV.

Veillez ne pas utiliser le produit pour effectuer des mesures sur des circuits d'alimentation, ni l'utiliser pour des mesures de tension supérieures à la plage de tension décrite dans le manuel.

---

**CAT II** : La catégorie de mesure II correspond aux mesurages réalisés sur les circuits directement branchés à l'installation basse tension.

Exemples : alimentation d'appareils électrodomestiques et d'outillage portable.

**CAT III** : La catégorie de mesure III correspond aux mesurages réalisés dans l'installation du bâtiment.

Exemples : tableau de distribution, disjoncteurs, machines ou appareils industriels fixes.

**CAT IV** : La catégorie de mesure IV correspond aux mesurages réalisés à la source de l'installation basse tension.

Exemples : compteurs et mesurage sur les dispositifs de protection contre les surintensités et sur les systèmes de régulation. de l'ondulation

## Conditions d'utilisation

### Température, Humidité

Opération: 10°C ~ +40°C

Non-fonctionnement: - 20°C ~ +70°C

Humidité:

<+35°C: ≤90% humidité relative

+35°C ~ +40°C: ≤60% humidité relative



#### Attention

Pour éviter le court-circuit à l'intérieur de l'instrument ou de la décharge électrique, svp ne fonctionnez pas dans l'environnement humide.

---

### Altitude

Opération: < 3 km

Non-fonctionnement: < 15 km

### Degré de protection

IP20

### La catégorie d'installation (surtension)

ce produit est actionnée par des forces conformément à la catégorie II. d'installation (surtension).



#### Attention

Assurez-vous qu'aucune surtension (comme cela provoqué par coup de foudre) ne peut atteindre le produit, ou bien l'opérateur pourrait exposer au danger de la décharge électrique.

---

### Définitions de catégorie d'installation (surtension)

La catégorie II d'installation (surtension) se rapporte au niveau local de distribution d'énergie qui est applicable à l'équipement relié à la ligne à C.A. (courant alternatif).



---

## Condition de ventilation

L'oscilloscope utilise un refroidissement par air forcé. Veillez à ce que les zones d'entrée et de sortie d'air ne soient pas obstruées et ventilées de manière adéquate. Lorsque l'oscilloscope est utilisé sur un support de paillasse ou de rack, prévoyez un dégagement d'au moins 10 cm autour de l'instrument pour assurer une ventilation adéquate.



### Attention

Une ventilation inadéquate peut entraîner une augmentation de la température, ce qui pourrait endommager l'oscilloscope. Veuillez garder le produit bien ventilé pendant l'opération et inspecter régulièrement l'admission et le ventilateur.

---

## Entretien et nettoyage

Ne pas garder ou laisser l'instrument en plein soleil pendant longtemps.



---

**Attention**

Pour éviter d'endommager l'instrument ou la sonde, veuillez ne pas exposer l'appareil au brouillard ou le déposer dans un liquide ou un solvant.

---

### nettoyage

Veillez suivre les étapes suivantes pour nettoyer régulièrement l'instrument et la sonde et ce, en fonction des conditions d'utilisation

1. Débranchez l'appareil de toute alimentation électrique, puis le nettoyer avec un chiffon doux.
2. Enlevez, en gros, la poussière à l'extérieur de l'instrument et de la sonde. Quand vous nettoyez l'écran LCD, faites attention pour éviter de l'endommager ou de le rayer.



---

**Attention**

Pour éviter d'endommager la surface de l'instrument et de la sonde, veuillez ne pas utiliser de liquide corrosif ou de nettoyant chimique.

---



---

**Attention**

Assurez-vous que l'instrument est complètement sec avant de le redémarrer pour éviter court-circuit ou blessures corporelles.

---

---

# Document Overview

This manual introduces how to use the SDS2000X series digital oscilloscope in detail.

## [Quick Start](#)

Provides information about preparations before using the instrument and a brief introduction of the key instrument features

## [To Set the Vertical System](#)

Introduces the functions of the vertical system of the oscilloscope

## [To Set the Horizontal System](#)

Introduces the functions of the horizontal system of the oscilloscope

## [To Set the Sample System](#)

Introduces the functions of the sample system of the oscilloscope

## [To Trigger the Oscilloscope](#)

Introduces the trigger modes, trigger coupling, trigger holdoff, external trigger and various trigger types of the oscilloscope

## [Serial Trigger and Decode](#)

Introduces how to trigger and decode an input signal

## [Digital Channels](#)

Introduces how to set up and use the digital channels

## [To Save Reference Waveform](#)

Introduces how to save and display reference waveforms

## [To Use the Math Operation](#)

Introduces the math operation functions of the oscilloscope

## [To Make Cursor Measurements](#)

Introduces how to use cursors to make measurements

## [To Make Measurements](#)

Introduces how to use measure functions to measure the waveform parameters

## [To Use the History Function](#)

Introduces the History function and how to use it  
Introduces how to set the display of the oscilloscope

## [Display Setting](#)

## [Save and Recall](#)

Introduces how to save and recall the measurement result and the setting of the oscilloscope

## [System Function Setting](#)

Introduces how to configure the system setup

## [Arbitrary Waveform Generation](#)

Introduces how to use the arbitrary waveform generation function

## [Default Setup](#)

Introduces the Default setup of the oscilloscope

## [Troubleshooting](#)

Introduces how to deal with common problems

## Content Conventions in this Manual

---

This manual uses the SDS2304X in examples and the descriptions shown list all the functions and performances of other models. SDS2000X series includes the following models:

<b>Model</b>	<b>Analogy Bandwidth</b>	<b>channels</b>
SDS2304X	300 MHz	4
SDS2204X	200 MHz	4
SDS2104X	100 MHz	4
SDS2074X	70 MHz	4
SDS2302X	300 MHz	2
SDS2202X	200 MHz	2
SDS2102X	100 MHz	2
SDS2072X	70 MHz	2

**Table of Contents**

Copyright and Declaration..... I

Safety Information ..... II

    General Safety Summary..... II

    Safety Terms and Symbols ..... IV

    Measurement Category ..... V

    Working Environment..... VI

    Ventilation Requirement..... VII

    General Care and Cleaning..... VIII

Document Overview ..... XVII

Quick Start ..... 1

    General Inspection..... 2

    Appearance and Dimensions ..... 3

    To Prepare the Oscilloscope for Use ..... 4

        To Adjust the Supporting Legs..... 4

        To Connect to Power Supply ..... 5

        Power-on Inspection ..... 6

        To Connect the Probe..... 7

        Functional Inspection ..... 8

        Probe Compensation..... 9

    The Front Panel..... 10

    The Rear Panel ..... 11

    Front Panel Function Overview ..... 12

        Horizontal..... 12

        Vertical ..... 13

        Trigger ..... 15

        Run Control ..... 16

        Universal Knob..... 17

        Menu ..... 18

        Help ..... 19

    User Interface..... 20

        To Use the Security Lock ..... 22

To Set the Vertical System..... 23

    To Enable the Channel..... 24

    To Adjust the Vertical Scale ..... 25

    To Adjust the Vertical Position ..... 25

    To Specify Channel Coupling..... 26

    To Specify Bandwidth Limit..... 26

    To Specify Probe Attenuation Factor ..... 27

    To Specify channel Input Impedance ..... 27

    To Specify Amplitude Unit..... 28

    To Invert a Waveform..... 28

Set the Horizontal System.....	29
Adjust the Horizontal Scale .....	30
Adjust Trigger Delay.....	31
Set the Roll mode.....	32
Use the Zoom Function .....	33
To Set the Sample System .....	34
Run Control .....	35
Overview of Sampling.....	36
Sampling Theory .....	36
Sample Rate .....	37
Oscilloscope Bandwidth and Sample Rate .....	38
To Specify Memory Depth.....	39
To Select Sampling Mode .....	39
To Select Waveform Interpolation Method .....	40
To Select Acquisition Mode .....	42
Normal.....	42
Peak Detect .....	43
Average .....	44
Eres (Enhanced Resolution) .....	45
To Change the Horizontal Format .....	46
Use Sequence Mode .....	47
To Trigger the Oscilloscope.....	49
Trigger Source .....	51
Trigger Mode .....	52
Trigger Level .....	53
Trigger Coupling .....	54
Trigger Holdoff .....	55
Noise Rejection .....	56
Trigger Type.....	58
Edge Trigger .....	59
Slope Trigger .....	60
Pulse Trigger .....	62
Video Trigger.....	64
Window Trigger .....	67
Interval Trigger .....	70
DropOut Trigger.....	72
Runt Trigger .....	74
Pattern Trigger.....	76
Serial trigger and decode .....	78
IIC Trigger and Serial Decode .....	79
Setup for IIC Signals.....	79
IIC Triggering .....	81
IIC Serial Decode.....	85
SPI Triggering and Serial Decode .....	87

---

Setup for SPI Signals .....	87
SPI Triggering .....	90
SPI Serial Decode .....	92
UART/RS232 Trigger and Serial Decode .....	94
Setup for UART/RS232 Signals .....	94
UART/RS232 Triggering .....	96
UART/RS232 Serial Decode .....	98
CAN Trigger and Serial Decode .....	100
Setup for CAN Signals .....	100
CAN Triggering .....	102
CAN Serial Decode .....	104
LIN Triggering and Serial Decode .....	106
Setup for LIN Signals .....	106
LIN Triggering .....	107
LIN Serial Decode .....	109
Digital Channels .....	111
To Connect the Digital Probes to the Device-under-test .....	112
Acquiring Waveform Using the Digital Channels .....	113
To Change the Display Type of the Digital Channels .....	113
To Switch a Single Channel On or Off .....	115
To Switch All Digital Channels On or Off .....	115
To Change the Logic Threshold for Digital Channels .....	115
To Reposition a Digital Channel .....	116
To Display Digital Channels as a Bus .....	116
To Save Reference Waveform .....	118
To Save REF Waveform to Internal Memory .....	119
To Display REF Waveform .....	119
To Adjust REF Waveform Display .....	120
To Clear REF Waveform Display .....	120
To Use the Math Operation .....	121
Units for Math Waveforms .....	122
Math Operators .....	123
Addition or Subtraction .....	123
Multiplication and Division .....	124
FFT Operation .....	125
Differentiate .....	129
Integrate .....	130
Square Root .....	131
To Adjust the Math Waveform Scale and Offset .....	132
To Adjust the Math Waveform Horizontal Scale and Offset .....	132
To Adjust the Math Waveform Vertical Scale and Offset .....	132
To Make Cursor Measurements .....	133
X Cursors .....	133
Y Cursors .....	133

---

To Make Cursor Measurements .....	134
To Make Measurements .....	135
Type of Measurement .....	136
Voltage Measurements .....	136
Time Measurements .....	138
Delay Measurements .....	139
To Make Automatic Measurements .....	140
To Clear Measurement Parameters .....	142
To Make All Measurement .....	142
Display Setting .....	143
To Set Display Type .....	144
To Set Color Display .....	145
To Set and Clear Persistence .....	145
To Clear the Display .....	146
To Select Grid Type .....	147
To Adjust Waveform Intensity .....	147
To Adjust Grid Brightness .....	149
To Adjust Transparence .....	149
Save and Recall .....	150
Save Type .....	151
Internal Save and Recall.....	152
External save and recall.....	153
Disk Management .....	156
To Create a New File or Folder.....	157
To delete a file or folder .....	158
To rename a file or a folder.....	158
System Function Setting .....	159
To View the System Status .....	160
To Do Self-Calibration .....	161
To Enable or Disable the Sound .....	162
To Specify the Language.....	162
To Enable Pass/Fail Test .....	163
To Set and Perform Pass/Fail Test.....	164
To Save and Recall Test Mask.....	165
I/O Set.....	167
To Set the USB Device .....	167
To Set the LAN .....	168
To Set Aux Output .....	169
To Do Power Analysis .....	170
To Perform Channel Deskew .....	171
Perform Power Analysis .....	173
To Enable Quick-Cal .....	197
To Update Firmware and Configuration .....	198
To Perform a Self-Test .....	199



---

Screen Test.....	199
Keyboard Test.....	200
LED Test.....	201
To Specify the Screen Saver Time .....	202
Option Management .....	203
To Use the History Function .....	205
Arbitrary Waveform Generator .....	207
To Set Wave Type and Parameters.....	208
To Output Arbitrary Waveform .....	210
To Set Output Load .....	211
Recover the Default Setup of AWG.....	211
To Do AWG Self-Cal .....	212
Default Setup.....	213
Troubleshooting .....	219

**Content of Figure**

Figure 1: Front View.....3

Figure 2: Top View .....3

Figure 3: Adjust the Supporting Legs.....4

Figure 4: To Connect to Power Supply.....5

Figure 5: Function Inspection.....8

Figure 6: Front Panel Overview.....10

Figure 7: Rear panel Overview .....11

Figure 8: Help Message .....19

Figure 9: User Interface .....20

Figure 10: To Use the Security Lock .....22

Figure 11: Display Type Set to Dots .....40

Figure 12: x Interpolation .....41

Figure 13: Sinx/x Interpolation .....41

Figure 14: Acquisition System .....42

Figure 15: Pulse With 0.1% Duty, Normal Mode .....43

Figure 16: Pulse With 0.1% Duty, Peak Detect Mode.....43

Figure 17: With Random Noise, Normal Mode .....44

Figure 18: With Random Noise, Average Mode .....45

Figure 19: Eres Mode.....45

Figure 20: SEQUENCE Function Menu .....47

Figure 21: HISTORY Function Menu.....47

Figure 22: Turn off Noise Reject.....56

Figure 23: Turn on Noise Reject.....56

Figure 24: Edge Trigger .....59

Figure 25: Slope Trigger .....60

Figure 26: Pulse Trigger.....63

Figure 27: Video Trigger.....66

Figure 28: Absolute Window Trigger .....68

Figure 29: Relative Window Trigger.....69

Figure 30: Interval Trigger .....71

Figure 31: Edge DropOut Trigger.....73

Figure 32: State DropOut Trigger .....73

Figure 33: Runt Trigger .....75

Figure 34: Pattern Trigger .....77

Figure 35: IIC SINGAL Menu .....79

Figure 36: IIC SIGNAL Menu .....79

Figure 37: IIC TRIGGER Menu .....84

Figure 38: IIC Decode Menu .....85

Figure 39: IIC Decode Result .....85

Figure 40: SINGAL Menu .....87

Figure 41: CLK Menu.....87

Figure 42: MISO Menu.....88

---

Figure 43: MOSI Menu.....	88
Figure 44: SPI TRIG SET Menu .....	90
Figure 45: SPI Trigger .....	91
Figure 46: SPI Decode .....	92
Figure 47: UART SIGNAL Menu .....	94
Figure 48: BUS CONFIG Menu .....	95
Figure 49: UART TRIG SET Menu.....	96
Figure 50: UART Trigger .....	97
Figure 51: CAN Decode.....	98
Figure 52: CAN SIGNAL Menu .....	100
Figure 53: CAN Trigger.....	103
Figure 54: CAN Decode.....	104
Figure 55: LIN SIGNAL Menu .....	106
Figure 56: LIN Trigger.....	108
Figure 57: LIN Decode.....	109
Figure 58: Digital Function Menu .....	113
Figure 59: Low Display Type .....	113
Figure 60: Middle Display Type .....	114
Figure 61: High Display Type .....	114
Figure 62: THRESHOLDS Function Menu .....	115
Figure 63: DIGITALBUS Function Menu .....	116
Figure 64: Digital Bus.....	117
Figure 65: Reference Waveform .....	120
Figure 66: Reference Waveform .....	123
Figure 67: Reference Waveform .....	124
Figure 68 FFT Waveform in Exclusive Mode.....	127
Figure 69: Differential Function Operation .....	129
Figure 70: Integral without Offset .....	130
Figure 71: Integral with Offset .....	131
Figure 72: Square Root .....	131
Figure 73: Measure Pulse Width.....	134
Figure 74: Voltage Measurements.....	136
Figure 75: Overshoot .....	137
Figure 76: Preshoot.....	137
Figure 77: Time Measurements .....	138
Figure 78: Select the Measurement Parameter.....	140
Figure 79: Add the Measurement.....	141
Figure 80: All Parameters Measurement.....	142
Figure 81: Vectors Display .....	144
Figure 82: Dots Display.....	144
Figure 83: Color Temperature .....	145
Figure 84: Persist Set to Infinite .....	146
Figure 85: Intensity Set to 100%.....	148
Figure 86: Intensity Set to 10% .....	148

---

Figure 87: SAVE/RECALL File System .....	153
Figure 88: Select Save Location.....	154
Figure 89: File Name Dialogue .....	154
Figure 90: Input Keyboard .....	157
Figure 91: System Status .....	160
Figure 92: Do Self Cal.....	161
Figure 93: Pass/Fail Test.....	163
Figure 94: LAN Setting Interface .....	168
Figure 95: DF2001A Deskew Fixture.....	172
Figure 96: Second Page of the UTILITY Function Menu .....	172
Figure 97: UTILITY Function Menu.....	172
Figure 98: Power Analysis SIGNAL Menu .....	172
Figure 99: Deskew Success .....	173
Figure 100: ANALYSIS Function Menu .....	174
Figure 101: Power Quality SIGNAL Menu.....	174
Figure 102: Perform Power Quality Analysis.....	175
Figure 103: Turn on Statistic Function .....	176
Figure 104: ANALYSIS Function Menu .....	177
Figure 105: Harmonics SINGAL Menu .....	177
Figure 106: Harmonics SETTING Menu .....	177
Figure 107: Harmonics Analysis .....	178
Figure 108: ANALYSIS Function Menu .....	180
Figure 109: Inrush Analysis SIGNAL Menu .....	180
Figure 110: Inrush Analysis .....	181
Figure 111: ANALYSIS Function Menu .....	182
Figure 112: Switching Analysis Signal Menu .....	182
Figure 113: Switching Analysis SETTINGS Menu.....	183
Figure 114: Switching Analysis.....	184
Figure 115: Slew Rate ANALYSIS Function Menu .....	185
Figure 116: Slew Rate Signal Menu .....	185
Figure 117: Perform Slew Rate Analysis .....	186
Figure 118: Modulation ANALYSIS Function Menu.....	187
Figure 119: Modulation SIGNAL Menu.....	187
Figure 120: Modulation Analysis .....	188
Figure 121: Output Ripple ANALYSIS Function Menu .....	189
Figure 122: Output Ripple SIGNAL Menu .....	189
Figure 123: Perform Output Ripple Analysis.....	190
Figure 124: Turn on Statistic Function .....	190
Figure 125: Turn On/Off ANALYSIS Function Menu .....	191
Figure 126: Turn On/Off SIGNAL Menu .....	191
Figure 127: Turn On/Off Analysis.....	192
Figure 128: Transient ANALYSIS Function Menu .....	193
Figure 129: Transient SIGNAL Menu .....	193
Figure 130: Transient SETTING Menu .....	194

---

Figure 131: Transient Analysis.....	194
Figure 132: Efficiency ANALYSIS Function Menu .....	195
Figure 133: Efficiency SIGNAL Menu .....	195
Figure 134: Perform Efficiency Analysis.....	196
Figure 135: Screen Test.....	199
Figure 136: Keyboard Test .....	200
Figure 137: LED Test.....	201
Figure 138: Screen Saver Interface.....	202
Figure 139: OPTION Function Menu.....	203
Figure 140: LABEL Function Menu .....	203
Figure 141: Option Information .....	204
Figure 142: History.....	205
Figure 143: Send Wave Dialogue .....	210
Figure 144: AWG Menu .....	210
Figure 145: SETTING Function Menu.....	211
Figure 146: AWG Self Cal .....	212



# Quick Start

This chapter introduces the preparations when using the oscilloscope for the first time, the front panel, rear panel and user interface of the oscilloscope,

The contents of this chapter:

- ◆ [General Inspection](#)
- ◆ [Appearance and Dimensions](#)
- ◆ [To Prepare the Oscilloscope for Use](#)
- ◆ [The Front Panel](#)
- ◆ [The Rear Panel](#)
- ◆ [Front Panel Function Overview](#)
- ◆ [User Interface](#)
- ◆ [To Use the Security Lock](#)

## General Inspection

### 1. Inspect the shipping container for damage.

Keep the damaged shipping container or cushioning material until the contents of the shipment have been completely checked and the instrument is passed both electrical and mechanical tests.

The consigner or carrier will be responsible for damages to the instrument resulting from shipment. **SIGLENT** does not provide free maintenance or replacement if the instrument has been damaged in shipment.

### 2. Inspect the instrument.

If there is mechanical damage or defect, or failure in the electrical and mechanical tests, please contact your SIGLENT distributor.

### 3. Check the accessories

Please check the accessories according to the packing list. If the accessories are incomplete or damaged, please contact your **SIGLENT** distributor.



## Appearance and Dimensions

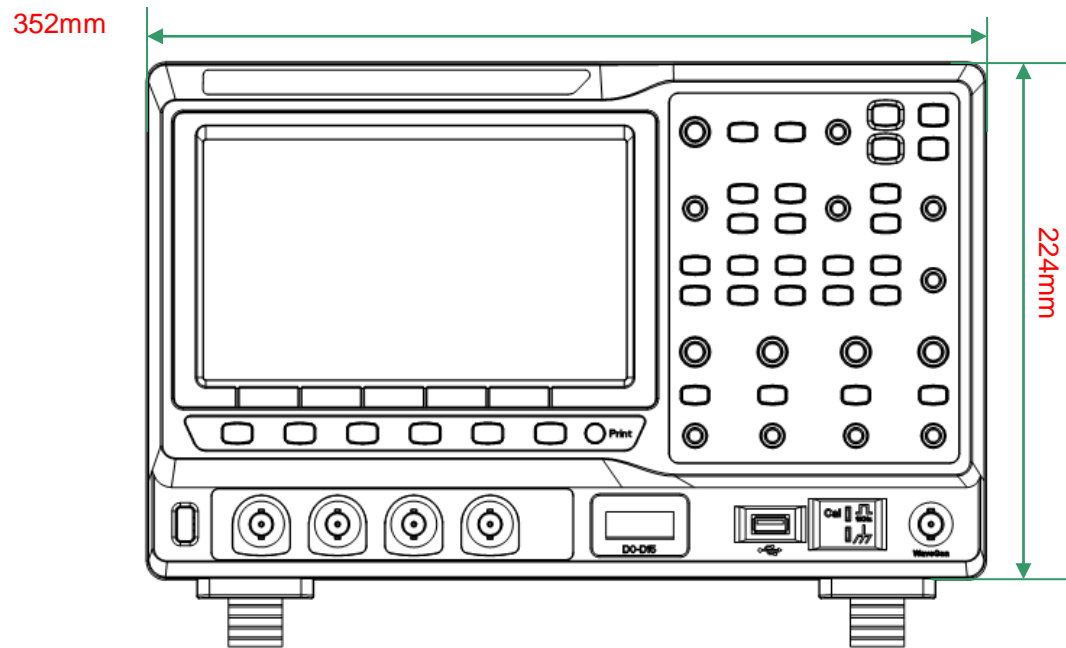

Figure 1: Front View

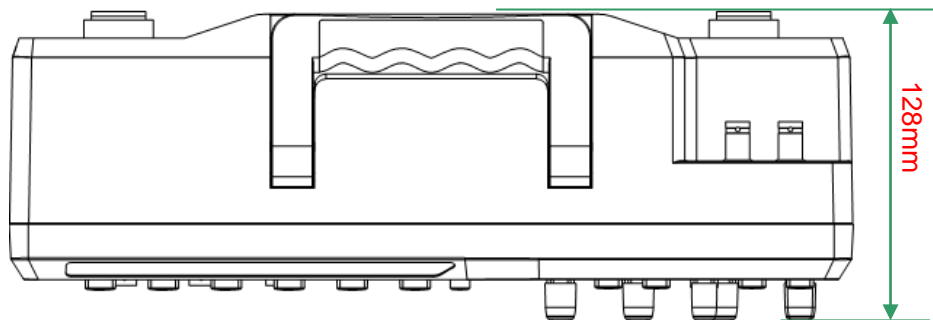

Figure 2: Top View

## To Prepare the Oscilloscope for Use

### To Adjust the Supporting Legs

Adjust the supporting legs properly to use them as stands to tilt the oscilloscope upwards for stable placement of the oscilloscope as well as better operation and observation.

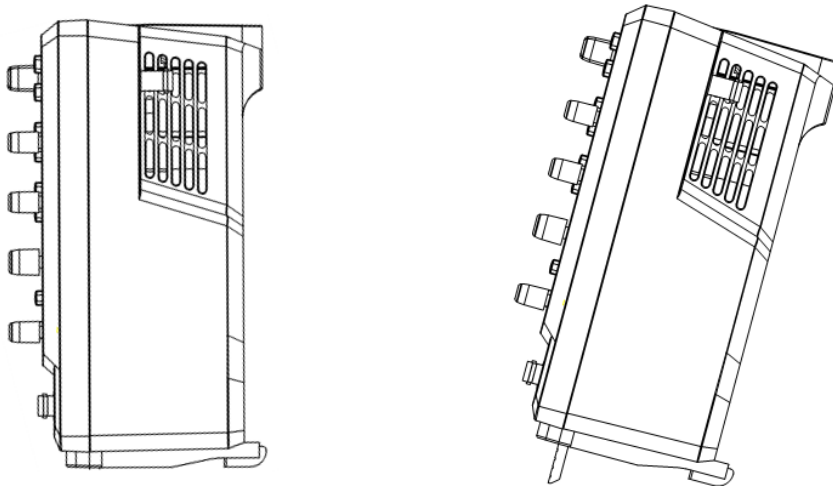

Figure 3: Adjust the Supporting Legs

## To Connect to Power Supply

The oscilloscope will accept a 100~240V, 50/60Hz or 100~120V, 400Hz power supply. Please use the power cord provided with the accessories to connect the instrument to the power source as shown in the figure below.

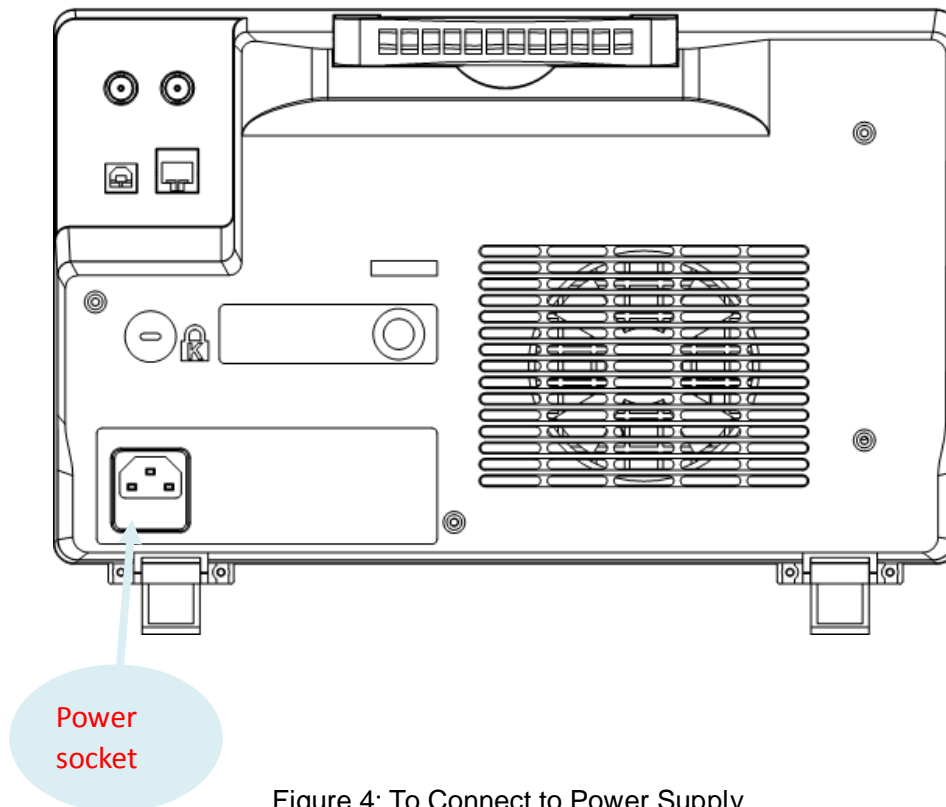

Figure 4: To Connect to Power Supply

## **Power-on Inspection**

When the oscilloscope is energized, press the power key at the lower-left corner of the front panel to start the oscilloscope. During the start-up process, the oscilloscope performs a series of self-tests and you can hear the sounds of relays switching. After the self-test is finished, the welcome screen is displayed.

## To Connect the Probe

**SIGLENT** provides passive probes for the SDS2000X series oscilloscopes. For detailed technical information of the probes, please refer to the corresponding Probe User's Guide.

### **Connect the Probe:**

1. Connect the BNC terminal of the probe to one of the channel BNC connectors on the front panel.
2. Connect the probe tip to the circuit point under test and the ground alligator clip of the probe to the ground terminal of the circuit.

## Functional Inspection

1. Press the **Default** button on the front panel to restore the instrument to its factory default configuration.
2. Connect the ground alligator clip of the probe to the “Ground Terminal” under the probe compensation signal output terminal.

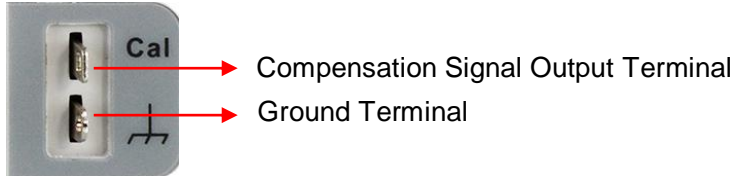

3. Use the probe to connect the input terminal of CH1 of the oscilloscope and the “Compensation Signal Output Terminal” of the probe.
4. Press the **Auto Setup** softkey.
5. Observe the waveform on the display. In normal condition, the display should be a square waveform as shown in the figure below:

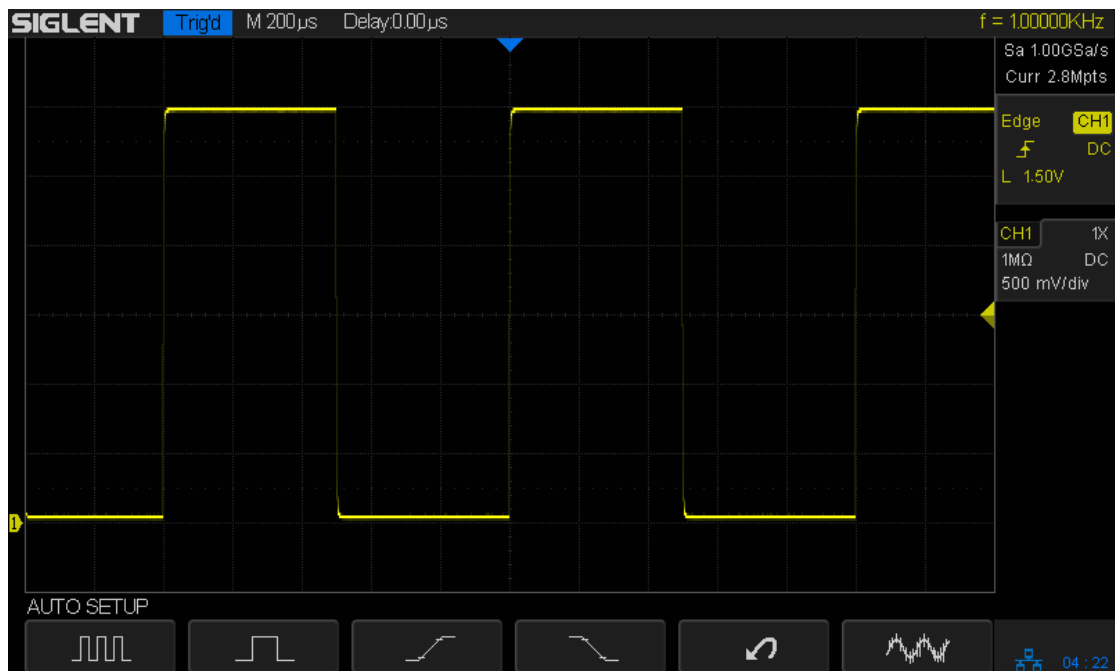

Figure 5: Function Inspection

6. Use the same method to test the other channels. If the square waveforms actually shown do not match that in the figure above, please perform “**Probe Compensation**” in the next section.



### WARNING

To avoid electric shock during the use of probe, please make certain that the insulated wire of the probe is in good condition and does not touch the metallic part of the probe when the probe is connected to high voltage source

## Probe Compensation

All oscilloscope probes should be properly compensated before their first use with the oscilloscope. Non-compensated or inadequate compensated probe may cause measurement inaccuracy or error. The probe compensation procedures are as follows.

1. Set the switch to 10X on the probe.
2. Perform steps 1, 2, 3 and 4 of “**Function Inspection**” in the previous section.
3. Check the waveforms displayed and compare them with the following:

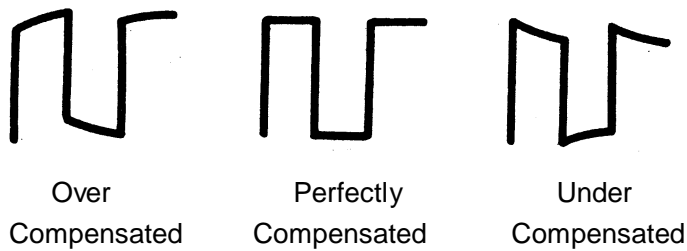

4. Use a nonmetallic flat-head screwdriver to adjust the low-frequency compensation adjustment hole on the probe until the waveform matches the “Perfectly Compensated” waveform above.

## The Front Panel

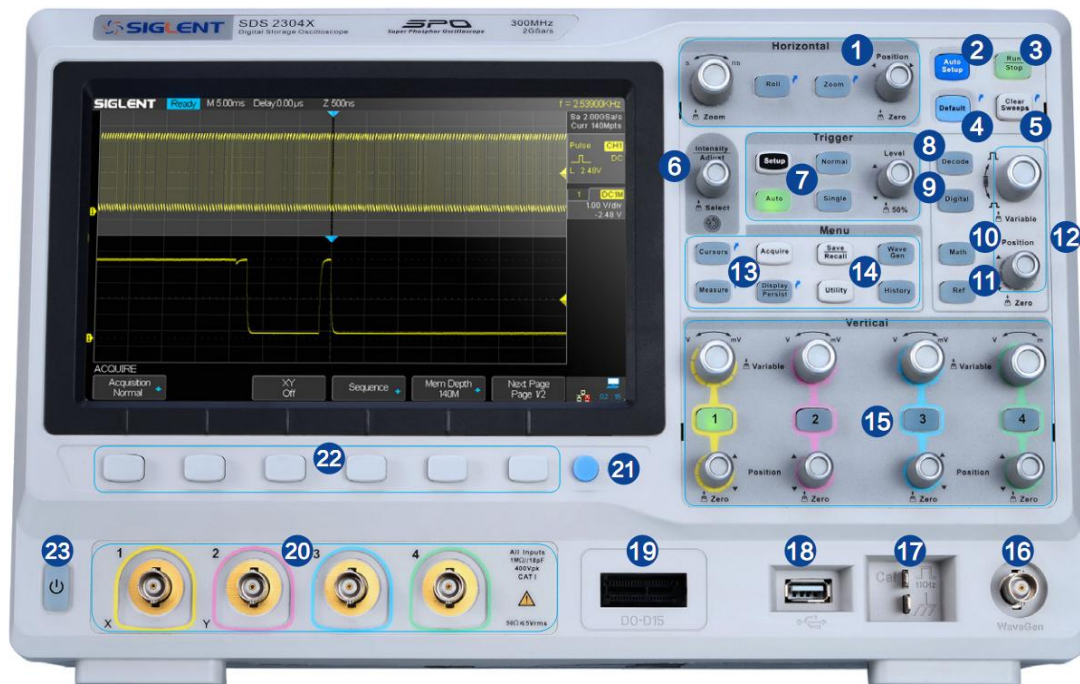

Figure 6: Front Panel Overview

NO.	Description	NO.	Description
1	Horizontal Control	13	Function Menus
2	Auto Setup	14	WaveGen Control
3	Run/Stop	15	Vertical Control for Analog Channels
4	Default Setup	16	WaveGen Output
5	Clear Sweeps	17	Probe Compensation/ Ground Terminal
6	Universal Knob	18	USB Host
7	Trigger Control	19	Digital Inputs
8	Decode Control	20	Analog Inputs
9	Digital Channel Control	21	One- Button shortcut for Save
10	Math Function	22	Function Menu Softkeys
11	Reference Function	23	Power On/Off
12	Vertical Control for Math and Ref		



## The Rear Panel

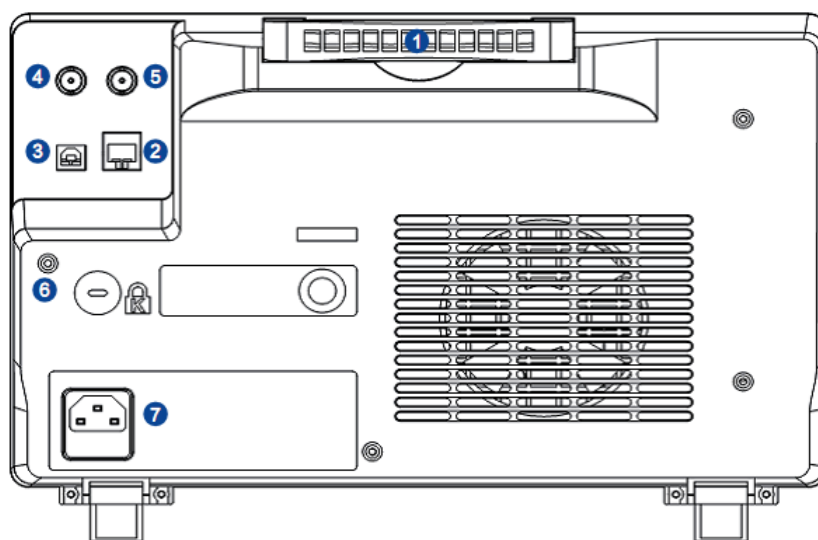

Figure 7: Rear panel Overview

### 1. Handle

Pull up the handle vertically for easy carrying of the instrument. When you do not need the handle, press it down.

### 2. LAN

The instrument can be connected to a user-network via this interface to perform remote control.

### 3. USB Device

The SDS2000X-series support SCPI remote control commands. User can control the oscilloscope through this interface.

### 4. Pass/Fail or Trigger Out

This connector outputs either a Pass/Fail pulse when using this mode of operation or it can be used to output a pulse that corresponds to each oscilloscope trigger operation.

### 5. External Trigger terminal

### 6. Safety lock Hole

This hole is designed to accommodate a Kensington style of lock (user-supplied).

### 7. AC Power Socket

AC power input terminal. The power requirements of this oscilloscope are 100-240 V, 50/60 Hz or 100-120 V, 400 Hz. Use the power cord provided with the instrument to connect it to AC power.

## Front Panel Function Overview

### Horizontal



Quickly enter the roll mode. The timebase range is from 50ms/div to 50s/div.



Press the button to open the Zoom function and press again to close the function.

**Horizontal Position Knob:**  Sets the horizontal location of the trigger event on the display. The waveform will move left or right when you turn the knob. Meanwhile, the Delay value will increase or decrease as the waveform moves. Press down the knob to reset the trigger delay to Zero.

**Horizontal Scale Knob**  Sets the timebase (horizontal sweep speed). Turn it clockwise or counterclockwise to reduce or increase the timebase. The displayed waveform will be expanded or compressed when the timebase changes. Press down the knob to enter into the Zoom mode.

## Vertical

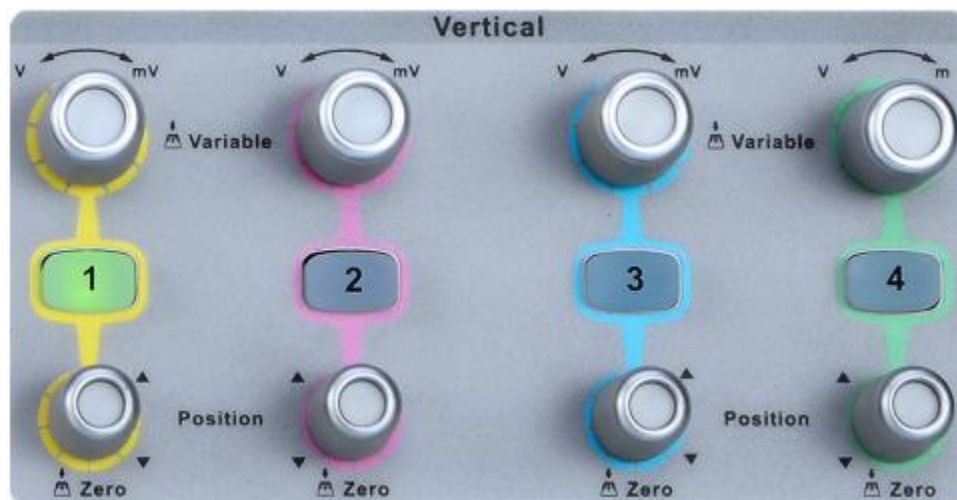



1 Analog input channels. The four channels are marked by different colors which are also used to mark both the waveforms on the screen and the channel input connectors. Press channel button to open the corresponding channel and press again to turn it off.

**Vertical Position Knob:**  Set the vertical offset of current waveform. Turn clockwise to increase the position and turn counterclockwise to decrease. When changing the offset, the waveform will move up and down and the offset message at the lower part of the screen will change accordingly. Press down the knob to quickly reset the offset to zero.

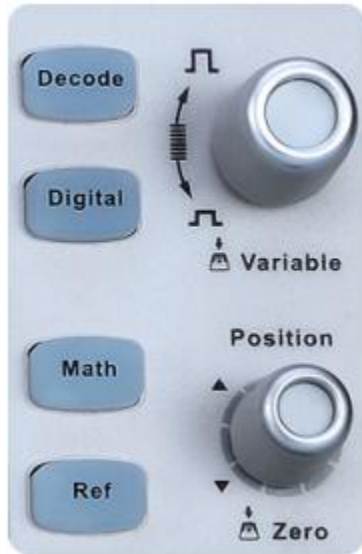
**Vertical Scale Knob:**  ; the vertical scale of current waveform. Turn clockwise to decrease the scale value and while turn counterclockwise to increase it. During the modification, the 'amplitude' of the waveform will enlarge or reduce and the scale message at the right side of the screen will also change. Press down the knob to quickly switch the vertical scale adjustment modes between "Coarse" and "Fine".



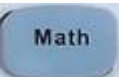

 Press this button to open decode menu. Decode is an optional function. SDS2000X supports two serial buses including 1 and 2 for analog signal decoding. The protocols include I2C, SPI, UART/RS232, CAN and LIN.

 Press the button to open the digital channel function menu (Optional function). The SDS2000X support 16 digital channels.

 Press the button to open the Math operation menu in order to select functions including add, subtract, multiply, divide, FFT, integral, differential, and square root.

 Press the button to enable the stored Reference waveform function. The reference waveform can be used in comparisons to the current waveform. SDS2000X supports saving up to 4 reference waveforms.

**Ref/Math Vertical Position Knob:**  Sets the vertical offset of Math or Ref waveform. Turn clockwise to increase the offset or turn counterclockwise to decrease the offset. During the modification, the waveform will move up and down and the offset message at the lower part of the screen will change accordingly. Press down the knob to quickly reset the offset to zero.

**Ref/Math Vertical Scale Knob**  Sets the vertical scale of Math or Ref waveform. Turn clockwise to decrease the scale or turn counterclockwise to increase it. During the modification, the 'amplitude' of the waveform will increase or decrease and the scale value displayed on the right side of the screen will change accordingly. In addition, the knob can be used to change a digital channel.

## Trigger



Press the button to open trigger menu. This oscilloscope provides various trigger types: Edge, Slope, Pulse, Video, Window, Interval, Dropout, Runt, Pattern and Serial Bus (I2C/SPI/UART/RS232/CAN/LIN).



Press the button to set to Auto trigger mode.



Press the button to set to Normal trigger mode.



Press the button to set to Single trigger mode.

**Trigger Level Knob:**  Sets the trigger level. Turn it clockwise or counterclockwise to make the level move up or down. In addition, the trigger level value is displayed in the upper right portion of the display. Press the knob to quickly reset the trigger level to 50% of waveform.

## Run Control



Press the button to enable the waveform auto setup function. The oscilloscope will automatically adjust the horizontal time base, vertical scale and trigger mode according to the input signal to provide a triggered stable display.



Press the button to set the state of the instrument to "RUN" or "STOP". In the "RUN" state, the button glows yellow; In "STOP" state, the button glows red.



Press the button to reset the oscilloscope to its default setup. The default voltage scale and timebase scale are respectively 1V/div and 1 $\mu$ s/div.

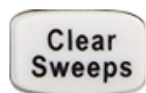

This button is a shortcut key for clear function. When measurement statistics are being displayed, press this button to clear the count and begin a new statistical count. When the screen persistence feature is turned on, press this button to clear the persistence.

## Universal Knob



### 1. Adjust the waveform intensity

When the menus are hidden, you can use the waveform intensity knob to adjust waveform intensity (0% ~ 100%). Turn clockwise to increase the brightness and counterclockwise to reduce. You can also press **Display/Persist** → **Intensity** and use the knob to adjust the intensity. To adjust grid brightness (0% ~ 100%) or transparency (20% ~ 80%), please operate in the same way as waveform intensity.

### 2. Universal Knob

In menu operation, the light below the knob is illuminated. In such cases, the knob can be used to select between submenus under the current menu. Press the knob to select the current submenu. In addition, it can be used to modify parameters and to input a file name.

## Menu

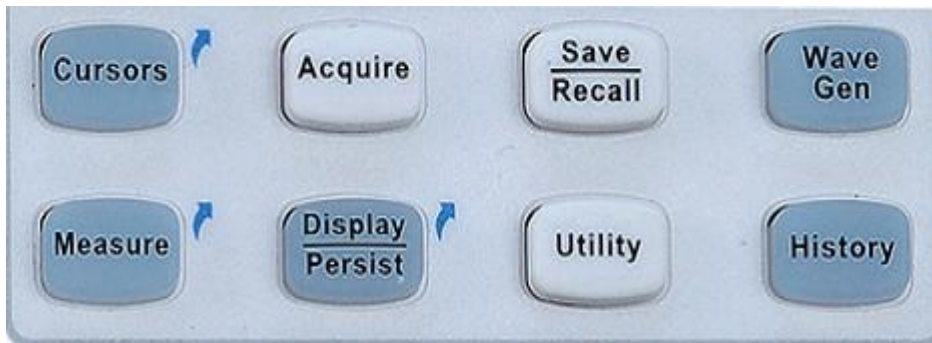

- Cursors** Press the button to open the cursor function. It provides manual and tracking cursor modes.
- Acquire** Press the button to enter the sampling menu. From here the acquisition mode can be set (Normal/Peak-Detect/Average/Eres), interpolation mode (Sin/x or linear) and memory depth. The XY mode can be selected here as well as the Sequence function.
- Save Recall** Press the button to enter the file save and recall function menu. The storable file types include Setups, Waveforms, Picture and References.
- Wave Gen** Press the button to open the WaveGen menu. The SDS2000X provides a built-in function generator (optional). 11 types of Waveforms including Sine, Square, Ramp, Pulse, DC, Noise, Cardiac, Gauss Pulse, ExpRise, ExpFall and Arb are supported.
- Measure** Press the button to enter the measurement setting menu. The user can set measurement type(s), statistics and gating. Up to five parameters can be selected.
- Display Persist** Press the button to enter the display menu and quickly enable the persist function. User can set the grid, Intensity, brightness, transparency.
- Utility** Press the button to enter the utility menu to set system functions or parameters, such as I/O set, sound, and screen language. In addition, some advanced functions (such as Pass/Fail, Self Cal, install option function and Update) are also supported.
- History** Press this button to enter the history mode. History mode can record up to 80,000 frames. If the Sequence function is enabled, only the selected frames are recorded (up to 80,000).



## Help

The SDS2000X has an on line help function that supplies multi-language help information, and you can recall then to help you operate the oscilloscope when you need.

Press any button for 2 seconds to enter the online help. All submenus of every main menu have their help information.

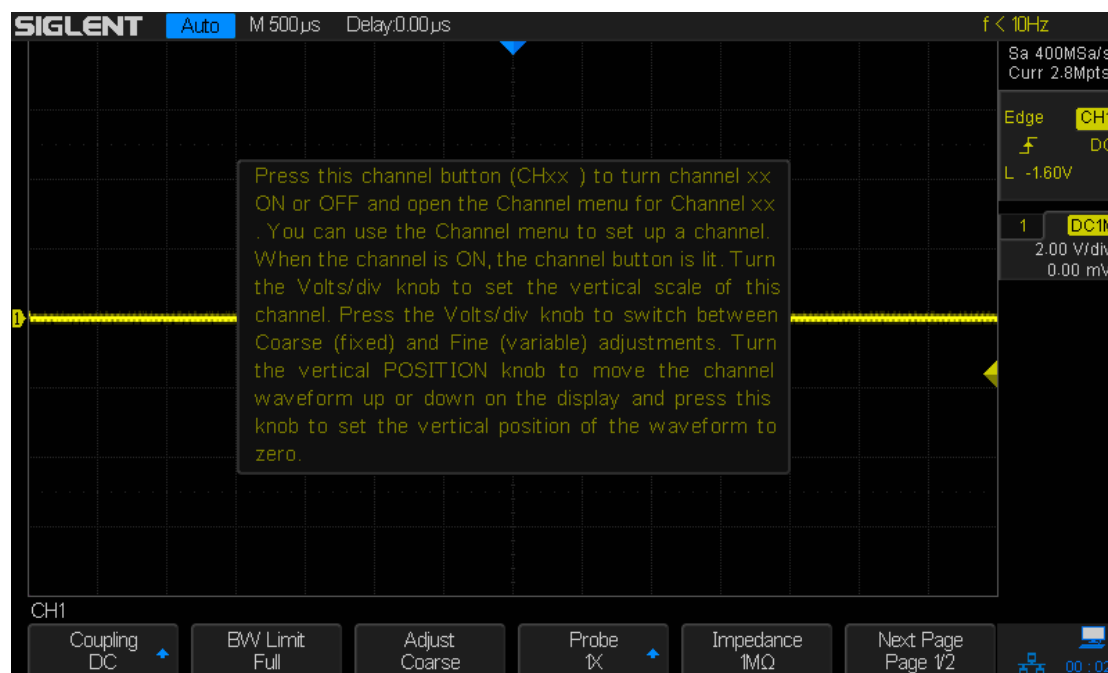

Figure 8: Help Message

## User Interface

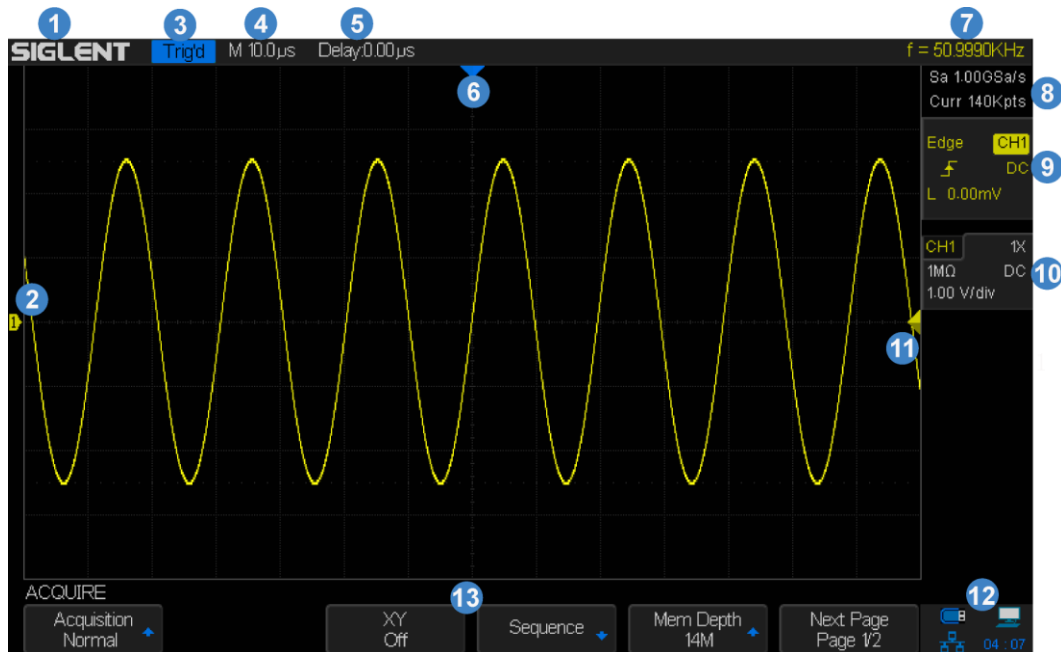

Figure 9: User Interface

### 1. Product Logo

**SIGLENT** is the registered trademark of **SIGLENT TECHNOLOGIES CO., LTD.**

### 2. Channel Label/Waveform

Different channels are marked by different colors and the color of the waveform matches with the color of the channel.

### 3. Trigger Status

Available trigger status includes Ready, Auto, Stop, Arm, Trig'd.

### 4. Horizontal Time Base

Represent the time of each grid on the horizontal axis of the screen. Turning the **HORIZONTAL SCALE Knob** changes the horizontal sweep speed within the range of 2ns/div to 50s/div.

### 5. Trigger Position

Use the **Horizontal POSITION Knob** to modify the parameter. Turn clockwise or counterclockwise to make the waveform move right or left, which will respectively cause the Delay parameter to decrease or increase. Press down the knob to automatically reset the parameter to zero as well as return the waveform's horizontal center to the middle of the screen.

## 6. Trigger Position Label

Display the trigger position of the waveform on the screen.

## 7. Frequency Counter

Display the frequency of current waveform as trigger source.

## 8. Sampling Rate/ Memory Depth

Display the current sample rate and memory depth of the oscilloscope. Use the Horizontal scale knob to modify the parameters.

## 9. Trigger Setup

Trigger Type  : Displays the currently selected trigger type and trigger condition setting. Different labels are displayed when different trigger types are selected.

Trigger source  : Displays the trigger source currently selected. Different labels are displayed when different trigger source are selected and the color of the trigger parameter area will change accordingly.

Trigger condition  : Displays the current trigger condition.

Trigger coupling  : Displays coupling mode (DC/AC/LF Reject/HF Reject) of the current trigger source.

Trigger level  : Displays the trigger level value of the current waveform. Press down the knob to reset the parameter to 50% of the waveform.

## 10. Channel Setup

Probe attenuation factor  : Displays currently selected probe attenuation factor. All factors are: 0.1X/0.2X/0.5X/1X/1000X/2000X/5000X/10000X.

Input impedance  : Displays currently selected impedance (1MΩ/50Ω) of the channel.

Channel coupling  : Displays the selected coupling mode of the current channel. All modes are: DC/AC/GND.

Vertical Scale  : Represents the voltage value of each grid on the vertical axis of the screen.

## 11. Trigger Level Label

Displays position of the current channel trigger level. Press down the knob to reset the level to vertical center of the waveform.

## 12. I/O status

 Indicates that the USB Device (USBTMC) is connected.

 Indicates that the USB Host is connected.

 Indicates that the LAN port is connected.  Indicates it is disconnected.

## 13. Menu

Display menus of the currently selected function module. Press any menu softkey to select or adjust the corresponding setting.

## To Use the Security Lock

Provisions for a Kensington-style lock are provided on the rear panel of the SDS2000X (Lock is not included). To use, align the lock with the lock hole and insert, turn the key clockwise to lock the instrument and then remove the key from the lock.

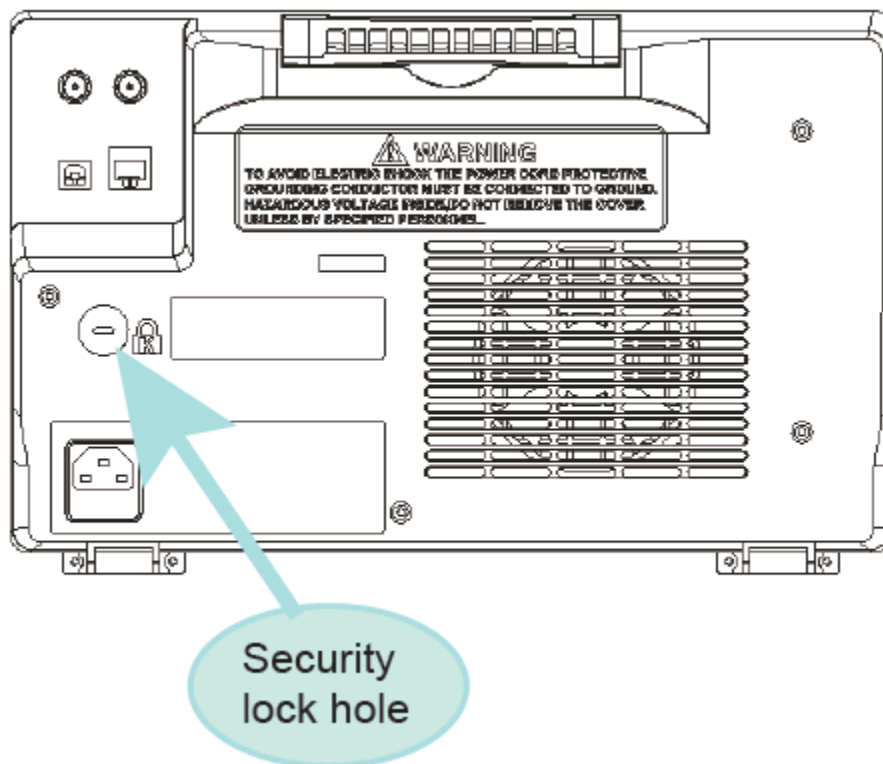

Figure 10: To Use the Security Lock

---

# To Set the Vertical System

This chapter introduces how to set the vertical system of the oscilloscope.

The contents of this chapter:

- ◆ [To Enable the Channel](#)
- ◆ [To Adjust the Vertical Scale](#)
- ◆ [To Adjust the Vertical Position](#)
- ◆ [To Specify Channel Coupling](#)
- ◆ [To Specify Bandwidth Limit](#)
- ◆ [To Specify Probe Attenuation Factor](#)
- ◆ [To Specify channel Input Impedance](#)
- ◆ [To Specify Amplitude Unit](#)
- ◆ [To Invert a Waveform](#)

## To Enable the Channel

SDS2000X provides 2/4 analog input channels (CH1, CH2, CH3, CH4) and provides independent vertical control system for each channel. As the vertical system setting methods of both channels are the same, this chapter takes CH1 as an example to introduce the configuration method of the vertical system.

Connect a signal to the CH1 channel connector; and then press the **CH1** button in the vertical control area (VERTICAL) at the front panel to enable CH1.

The channel setting menu is displayed at the bottom of the screen and the channel label at the right side of the screen. The information displayed in the channel label is related to the current channel setting.

After the channel is turned on, modify the parameters such as the vertical scale, the horizontal time base and the trigger mode according to the input signal to make the waveform display easy to observe and measure.

Note: To turn off the channel, press the channel button twice.

## To Adjust the Vertical Scale

The vertical scale can be adjusted in **Coarse** or **Fine** mode.

- **Coarse** adjustment (turning counterclockwise as an example): Set the vertical scale in 1-2-5 step namely 1mV/div, 2 mV/div, 5 mV/div, 10 mV/div ... 10 V/div.
- **Fine** adjustment: Further adjust the vertical scale within a relatively smaller range to improve vertical resolution. For example: 2 V/div, 1.98V/div, 1.96V/div, 1.94 V/div ... 1 V/div.

If the amplitude of the input waveform is a little bit greater than the full scale under the current scale and the amplitude would be a little bit lower if the next scale is used, fine adjustment can be used to improve the amplitude of waveform display to view signal details.

Press the **CH1** button on the front panel; then press the **Adjust** softkey to select the desired mode. Turn the **VERTICAL Scale Knob** to adjust the vertical scale (clockwise to reduce the scale and counterclockwise to increase).

The scale information in the channel label at the right side of the screen will change accordingly during the adjustment. The adjustable range of the vertical scale is related to the probe ratio currently set. By default, the probe attenuation factor is 1X and the adjustable range of the vertical scale is from 1mV/div to 10 V/div.

Note: Push the **VERTICAL Scale Knob** to quickly switch between **Coarse** and **Fine** adjustments.

## To Adjust the Vertical Position

Turn the **VERTICAL Position Knob** to adjust the vertical position of the channel waveform. Turn the knob clockwise to increase the vertical position and the channel waveform moves up while counterclockwise to reduce the vertical position and the waveform moves down. Push the knob to set the vertical position of the channel waveform to zero.

During the adjustment, the vertical position information Volts Pos displays at the bottom of the screen. The table below shows the range of vertical position according to the volt scale.

Volt Scale	Range of Vertical Position
1 mV/div ~ 100 mV/div	±1V
102 mV/div ~ 1 V/div	±10 V
1.02 V/div ~ 10 V/div	±100 V

## To Specify Channel Coupling

Set the coupling mode to filter out undesired signals. For this example, we will assume the signal-under-test is a square waveform with DC offset.

- When the coupling mode set to **DC**: The DC and AC components of the signal-under-test can both pass the channel.
- When the coupling mode set to **AC**: The DC components of the signal-under-test are blocked.
- When the coupling mode set to **GND**: The DC and AC components of the signal-under-test are both blocked.

Press the **CH1** button on the front panel; then press the **Coupling** softkey and turn the **Universal Knob** to select the desired coupling mode. The default setup is **DC**.

The current coupling mode is displayed in the channel label at the right side of the screen. You can also press the **Coupling** softkey continuously to switch the coupling mode.

## To Specify Bandwidth Limit

Set the bandwidth limit to reduce display noise. For example, the signal-under-test is a pulse with high frequency oscillation.

- When the bandwidth limit set to **full**, the high frequency components of the signal-under-test can pass the channel.
- When the bandwidth limit set to **20MHz**, the high frequency components that exceed 20 MHz are attenuated.

Press the **CH1** button the front panel; then press the **BW Limit** softkey to select **Full** or **20MHz**. The default setup is **Full**. When bandwidth limit is enabled, the character **B** will be displayed in the channel label at the right side of the screen.



## To Specify Probe Attenuation Factor

Set the probe attenuation factor to match the type of the probe that you are using to ensure correct vertical readouts.

Press the **CH1** button on the front panel; then press the **Probe** softkey and turn the **Universal Knob** to select the desired value and push the knob to confirm. The default setup is **1X**.

The current probe attenuation factor is displayed in the channel label at the right side of the screen. You can also press the **Probe** softkey continuously to switch the probe attenuation factor.

The table shows the probe attenuation factor

Menu	Attenuation Factor
0.1X	0.1 : 1
0.2X	0.2 : 1
0.5X	0.5 : 1
1X	1 : 1
2X	2 : 1
...	...
5000X	5000 : 1
10000X	10000 : 1

## To Specify channel Input Impedance

The channel input impedance matching gives you the most accurate measurements because reflections are minimized along the signal path.

- The 1M $\Omega$  Impedance setting is for use with many passive probes and for general-purpose measurements. The higher impedance minimizes the loading effect of the oscilloscope on the device-under-test.
- The 50 $\Omega$  Impedance setting matches 50 ohm cables commonly used in making high frequency measurements, and 50 ohm active probes.

Press the **CH1** button on the front panel; then press the **Impedance** softkey to select the desired impedance.

The current channel input impedance is displayed in the channel label at the right side of the screen.

## To Specify Amplitude Unit

Select the amplitude display unit for the current channel. The available units are **V** and **A**. When the unit is changed, the unit displayed in the channel label will change accordingly.

1. Press **CH1** button on the front panel to enter the CH1 function menu.
2. Press the **Next Page** softkey to enter the second page of the CH1 function menu.
3. Press the **Unit** softkey to select the desired unit **V** or **A**.

The default setup is **V**.

## To Invert a Waveform

When **Invert** is set to **On**, the voltage values of the displayed waveform are inverted. Invert affects how a channel is displayed and it keeps the trigger settings.

Inverting a channel also changes the result of any math function selected and measure function.

1. Press **CH1** button on the front panel to enter the CH1 function menu.
2. Press the **Next Page** softkey to enter the second page of the CH1 function menu.
3. Press the **Invert** softkey to turn on or off the invert display.

# Set the Horizontal System

This chapter introduces how to set the horizontal system of the oscilloscope.

The contents of this chapter:

- ◆ [Adjust the Horizontal Scale](#)
- ◆ [Adjust the Trigger Delay](#)
- ◆ [Set Roll Mode](#)
- ◆ [Use the Zoom Function](#)

## Adjust the Horizontal Scale

Turn the **HORIZONTAL Scale Knob** on the front panel to adjust the horizontal time base. Turn clockwise to reduce the horizontal time base and turn counterclockwise to increase.

The time base information at the upper left corner of the screen will change accordingly during the adjustment. The range of the horizontal scale is from 1ns/div to 50s/div.

**The Horizontal Scale Knob** works (in the Normal time mode) while acquisitions are running or when they are stopped. When in run mode, adjusting the horizontal scale knob changes the sample rate. When stopped, adjusting the horizontal scale knob lets you zoom into acquired data.

---

## Adjust Trigger Delay

Turn the Position Knob on the front panel to adjust the trigger delay of the waveform. During the modification, waveforms of all the channels will move left or right and the trigger delay message at the upper-right corner of the screen changes accordingly. Press down this knob to quickly reset the trigger delay.

Changing the delay time moves the trigger point (solid inverted triangle) horizontally and indicates how far it is from the time reference point. These reference points are indicated along the top of the display grid.

All events displayed left of the trigger point happened before the trigger occurred. These events are called pre-trigger information, and they show events that led up to the trigger point.

Everything to the right of the trigger point is called post-trigger information. The amount of delay range (pre-trigger and post-trigger information) available depends on the time/div selected and memory depth.

The position knob works (in the Normal time mode) while acquisitions are running or when they are stopped.

## Set the Roll mode

Press the **Roll** button to enter the roll mode.

In Roll mode the waveform moves slowly across the screen from right to left. It operates only on time base settings of 50 ms/div and slower. If the current time base setting is faster than the 50 ms/div limit, it will be set to 50 ms/div when Roll mode is entered.

In Roll mode triggering is not supported. The fixed reference point on the screen is the right edge of the screen and refers to the current moment in time. Events that have occurred are scrolled to the left of the reference point. Since there is no trigger, no pre-trigger information is available.

If you would like to stop the display in Roll mode, press the **Run/Stop** button. To clear the display and restart an acquisition in Roll mode, press the **Run/Stop** button again.

Use Roll mode on low-frequency waveforms to yield a display much like a strip chart recorder. It allows the waveform to roll across the display.

## Use the Zoom Function

Zoom is a horizontally expanded version of the normal display. You can use Zoom to locate and horizontally expand part of the normal window for a more detailed (higher-resolution) analysis of signals.

Press the **HORIZONTAL Scale Knob** on the front panel to turn on the zoom function, and press the button again to turn off the function. When Zoom function is on, the display divides in half. The top half of the display shows the normal time base window and the bottom half displays a faster Zoom time base window.

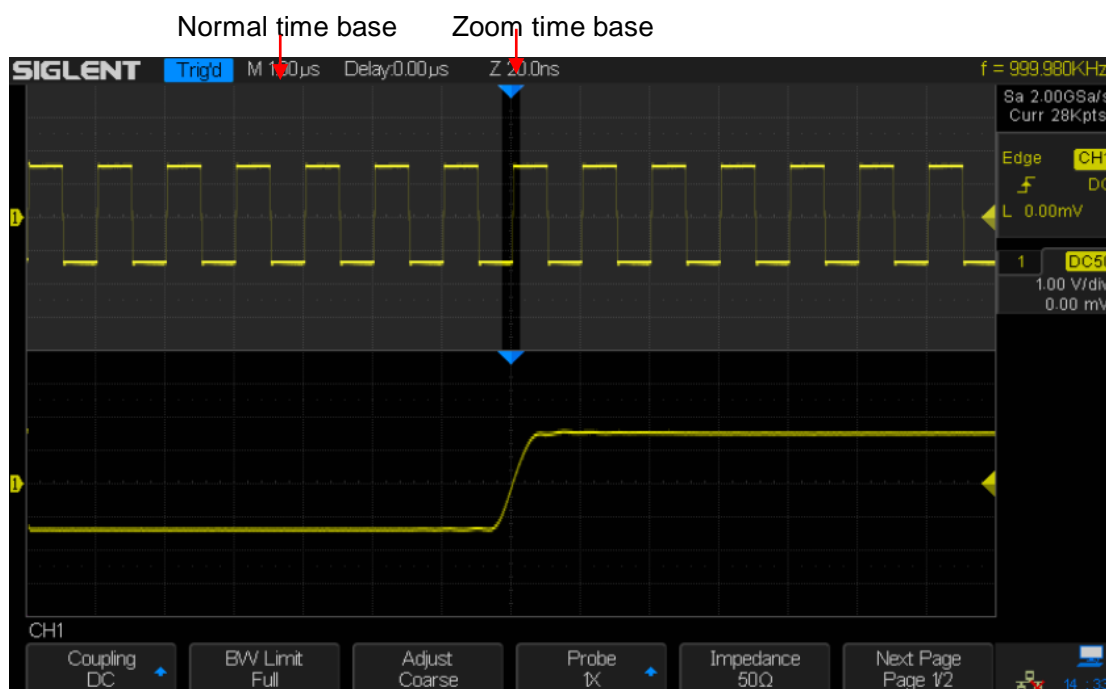

The area of the normal display that is expanded is outlined with a box and the rest of the normal display is ghosted. The box shows the portion of the normal sweep that is expanded in the lower half.

To change the time base for the Zoom window, turn the **Horizontal Scale Knob**. The **Horizontal Scale Knob** controls the size of the box. The **Horizontal Position Knob** sets the left-to-right position of the zoom window. The delay value, which is the time displayed relative to the trigger point is momentarily displayed in the upper-right corner of the display when the **Horizontal Position Knob** is turned. Negative delay values indicate that a portion of the waveform before the trigger event is displayed, and positive values indicate a portion of the waveform after the trigger event.

To change the time base of the normal window, turn off Zoom; then, turn the **Horizontal Scale Knob**.

# To Set the Sample System

This chapter introduces how to use the run control and set the sampling system of the oscilloscope.

The contents of this chapter:

- ◆ [Run Control](#)
- ◆ [Overview of Sampling](#)
- ◆ [To Specify Memory Depth](#)
- ◆ [To Select Sampling Mode](#)
- ◆ [To Select Waveform Interpolation Method](#)
- ◆ [To Select Acquisition Mode](#)
- ◆ [To Change the Horizontal Format](#)
- ◆ [Use Sequence Mode](#)



## Run Control

Press the **Run/Stop** or **Single** button on the front panel to run or stop the sampling system of the scope.

- When the **Run/Stop** is green, the oscilloscope is running, that is, acquiring data when trigger conditions are met. To stop acquiring data, press the **Run/Stop** button. When stopped, the last acquired waveform is displayed.
- When the **Run/Stop** button is red, data acquisition is stopped. This is indicated by a "Stop" displayed next to the trademark logo in the status line at the top of the display. To start acquiring data, press **Run/Stop**.
- To capture and display a single acquisition (whether the oscilloscope is running or stopped), press **Single**. The **Single** run control lets you view single-shot events without subsequent waveform data overwriting the display. Use **Single** when you want maximum memory depth for pan and zoom.

When **Single** is pressed the display is cleared, the trigger mode is temporarily set to Normal (to keep the oscilloscope from auto-triggering immediately), the trigger circuitry is armed, the **Single** key is illuminated, and the oscilloscope waits until a user defined trigger condition occurs before it displays a waveform.

When the oscilloscope triggers, the single acquisition is displayed and the oscilloscope is stopped (the **Run/Stop** button is illuminated in red).

Press **Single** again to acquire another waveform

## Overview of Sampling

To understand the oscilloscope's sampling and acquisition modes, it is helpful to understand sampling theory, sample rate and oscilloscope bandwidth.

### Sampling Theory

The Nyquist sampling theorem states that for a limited bandwidth (band-limited) signal with maximum frequency  $f_{MAX}$ , the equally spaced sampling frequency  $f_s$  must be greater than twice the maximum frequency  $f_{MAX}$ , in order to have the signal be uniquely reconstructed without aliasing.

$f_{MAX} = f_s/2 = \text{Nyquist frequency } (f_N) = \text{folding frequency}$

## Sample Rate

The maximum sample rate of SDS2000X is 2GSa/s. The actual sample rate of the oscilloscope is determined by the horizontal scale and acquisition depth. Turn the **Horizontal Scale Knob** to adjust the sample rate.

The current sample rate is displayed in the information area at the upper-right corner of the screen.

The influence on the waveform when the sample rate is too low:

1. **Waveform Distortion:** when the sample rate is too low, some waveform details are lost and the waveform displayed is rather different from the actual signal.

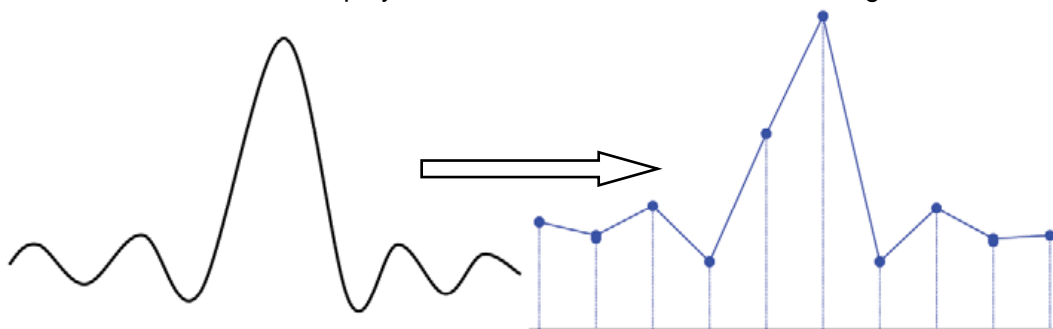

2. **Waveform Aliasing:** when the sample rate is lower than twice the actual signal frequency (Nyquist Frequency), the frequency of the waveform rebuilt from the sample data is lower than the actual signal frequency. The most common aliasing is the jitter on fast edge.

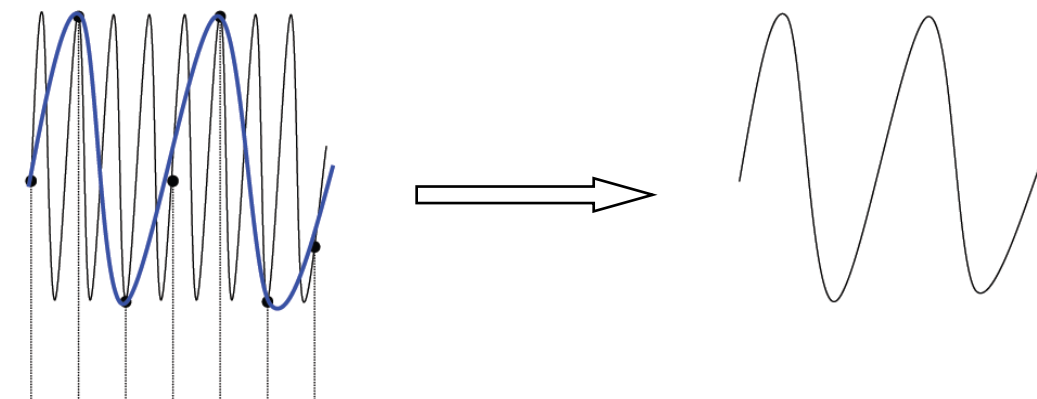

3. **Waveform Leakage:** when the sample rate is too low, the waveform rebuilt from the sample data does not reflect all the actual signal information.

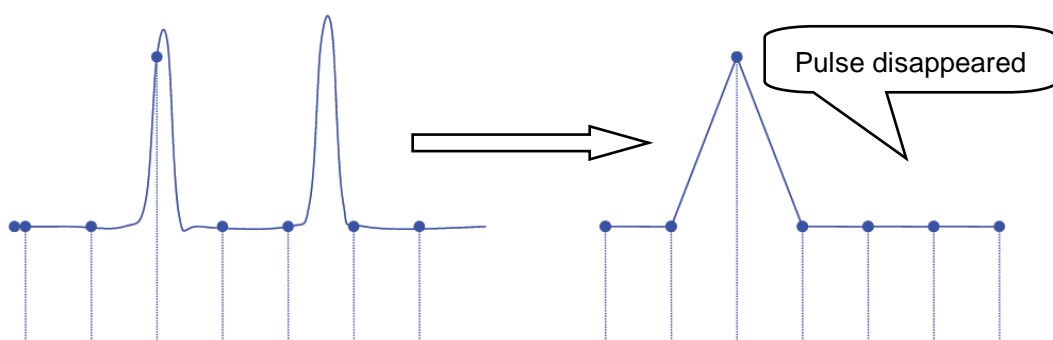

## Oscilloscope Bandwidth and Sample Rate

An oscilloscope's bandwidth is typically described as the lowest frequency at which input signal sine waves are attenuated by 3 dB (-30% amplitude error).

At the oscilloscope bandwidth, sampling theory says the required sample rate is  $f_s = 2f_{BW}$ . However, the theory assumes there are no frequency components above  $f_{MAX}$  ( $f_{BW}$  in this case) and it requires a system with an ideal brick-wall frequency response.

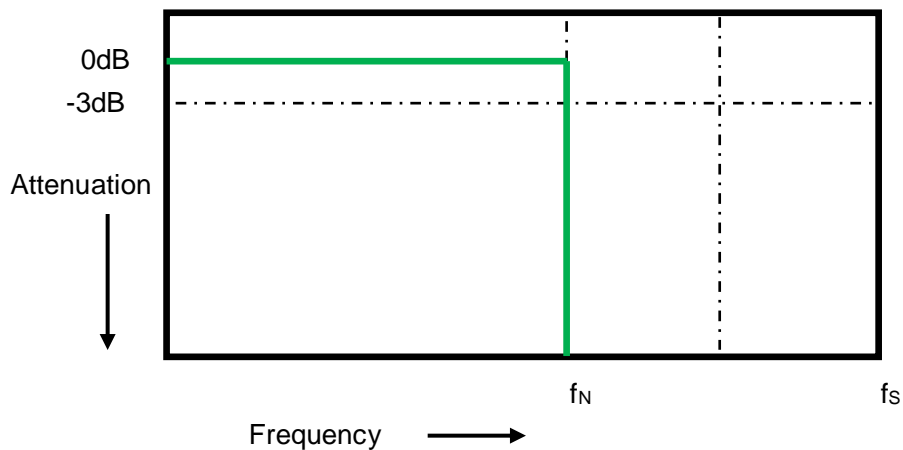

However, digital signals have frequency components above the fundamental frequency (square waves are made up of sine waves at the fundamental frequency and an infinite number of odd harmonics), and typically, for 500 MHz bandwidths and below, oscilloscopes have a Gaussian frequency response.

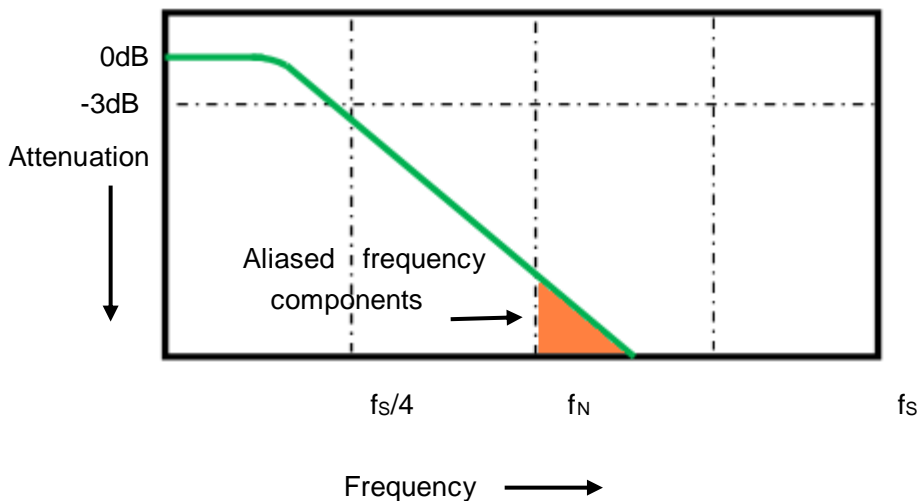

Limiting oscilloscope bandwidth ( $f_{BW}$ ) to  $1/4$  the sample rate ( $f_s/4$ ) reduces frequency components above the Nyquist frequency ( $f_N$ ).

So, in practice, an oscilloscope's sample rate should be four or more times its bandwidth:  $f_s = 4f_{BW}$ . This way, there is less aliasing, and aliased frequency components have a greater amount of attenuation.

---

## To Specify Memory Depth

Memory depth refers to the number of waveform points that the oscilloscope can store in a single trigger sample and it reflects the storage ability of the sample memory. The SDS2000X provides up to 140 Mpts memory depth.

Press the **Acquire** button on the front panel; press the **Mem Depth** softkey and then turn the **Universal Knob** to select the desired value and push down the knob to confirm. Press the **Mem Depth** softkey continually can also select the desired value.

The actual memory depth is displayed in the information area at the upper-right corner of the screen.

Since the oscilloscope has two acquisition memories, when only one channel is on, the maximal memory depth is up to 140Mpts.

The relation of memory depth, sample rate and waveform length fulfills the equation below:

Memory depth = sample rate (Sa/s) × waveform length (s/div × div)

## To Select Sampling Mode

The SDS2000X only supports real-time sampling. In this mode, the oscilloscope samples and displays waveform within a trigger event. The maximum real-time sample rate of SDS2000X is 2GSa/s.

Press the **RUN/STOP** button to stop the sample, the oscilloscope will hold the last display. At this point, you can still use the vertical control and horizontal control to explore the waveform.

## To Select Waveform Interpolation Method

Under real-time sampling, the oscilloscope acquires the discrete sample values of the waveform being displayed. In general, a waveform comprised of a singular dot per sample point is very difficult to observe. In order to increase the visibility of the signal, the digital oscilloscope usually uses the interpolation method to display a waveform.

The interpolation method “connects all the sampled points”, to estimate the whole appearance of the waveform. The oscilloscope can use interpolation to fill in the gaps between points and accurately reconstruct a waveform.

Press the **Acquire** button on the front panel to enter the ACQUIRE Function menu; then press the **Interpolation** softkey to select **Sinx/x** or **x**.

- **x**: In the adjacent sample points are directly connected on a straight line. This method is confined to rebuild on the edge of signals, such as square wave.
- **Sinx/x**: Connecting the sampling points with curves has stronger versatility. Sinx/x interpolation method uses mathematical processing to calculate results in the actual sample interval. This method involves bending the signal waveform, and allows it to produce a more realistic shape than pure square wave and pulse. When the sampling rate is 3 to 5 times the bandwidth of the system, the Sinx/x interpolation method is recommended.



Figure 11: Display Type Set to Dots

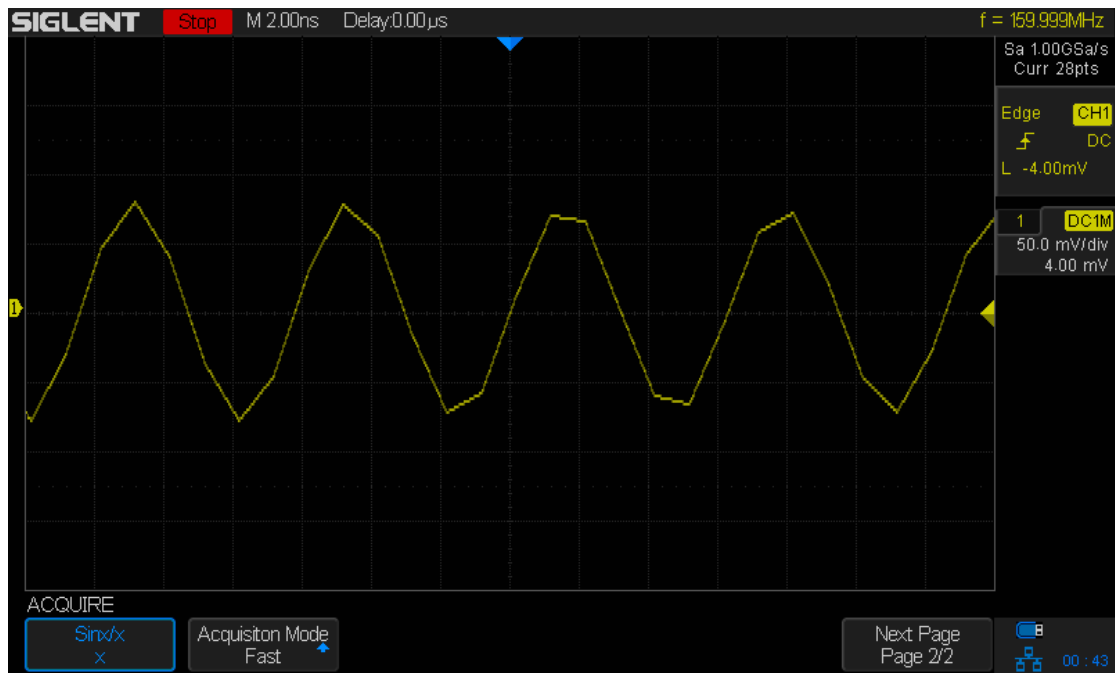

Figure 12: x Interpolation

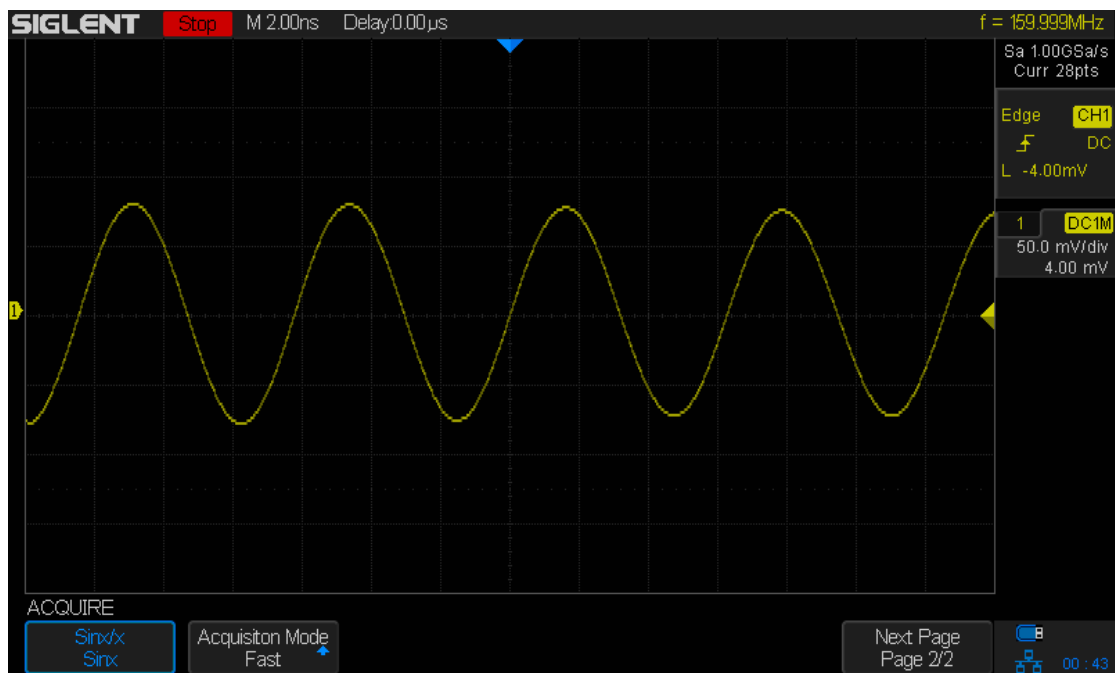

Figure 13: Sinx/x Interpolation

## To Select Acquisition Mode

The acquisition mode is used to control how to generate waveform points from sampled points. SDS2000X provides the following acquisition mode: Normal, Peak Detect, Average and Eres.

1. Press the **Acquire** button on the front panel to enter the ACQUIRE function menu;
2. Press the **Acquisition** softkey; then turn the **Universal Knob** to select the desired acquisition mode and push down the knob to confirm. The default setup is **Normal**.

### Normal

In this mode, the oscilloscope samples the signal at equal time interval to rebuild the waveform. For most of the waveforms, the best display effect can be obtained using this mode. It is the default acquisition mode.

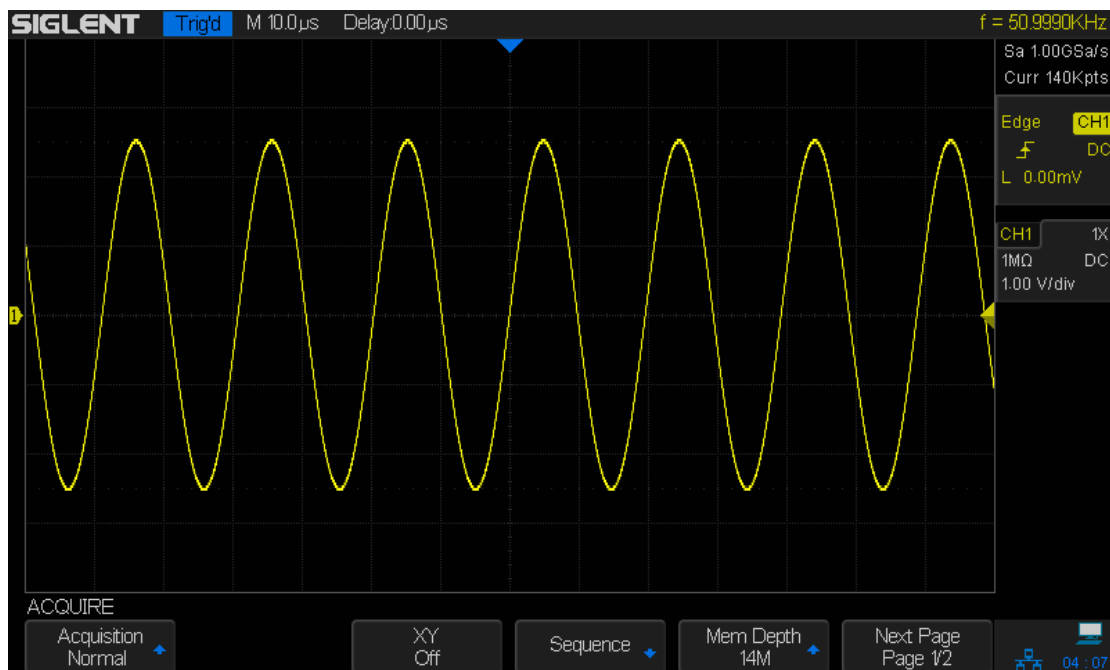

Figure 14: Acquisition System



## Peak Detect

In this mode, the oscilloscope acquires the maximum and minimum values of the signal within the sample interval to get the envelope of the signal or the narrow pulse of the signal that might be lost. In this mode, signal aliasing can be prevented but the noise displayed would be larger.

In this mode, the oscilloscope can display all the pulses with pulse widths as small as 1ns.



Figure 15: Pulse With 0.1% Duty, Normal Mode

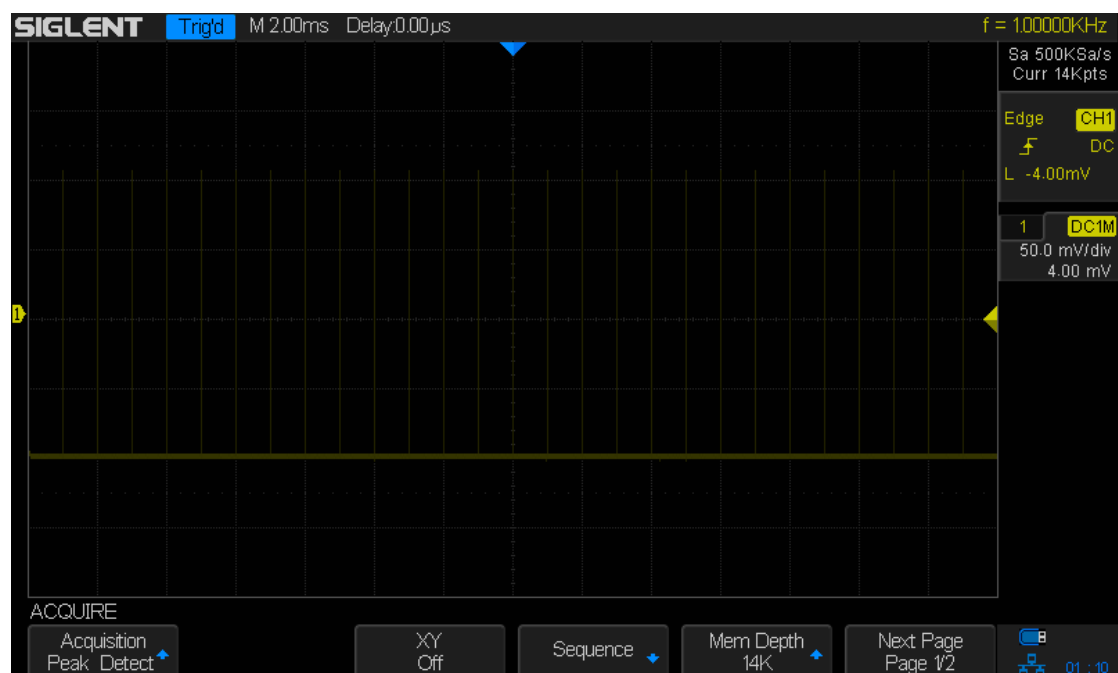

Figure 16: Pulse With 0.1% Duty, Peak Detect Mode

## Average

In this mode, the oscilloscope averages the waveforms from multiple frames to reduce the random noise of the input signal and improve the vertical resolution. The greater the number of averages is, the lower the noise will be and the higher the vertical resolution will be but the slower the response of the displayed waveform to the waveform changes will be.

The available range of averages is from 4 to 1024 with a default value of 16. When Average mode is selected, press **Averages** and turn the universal knob or press the softkey continually to set the desired average time.

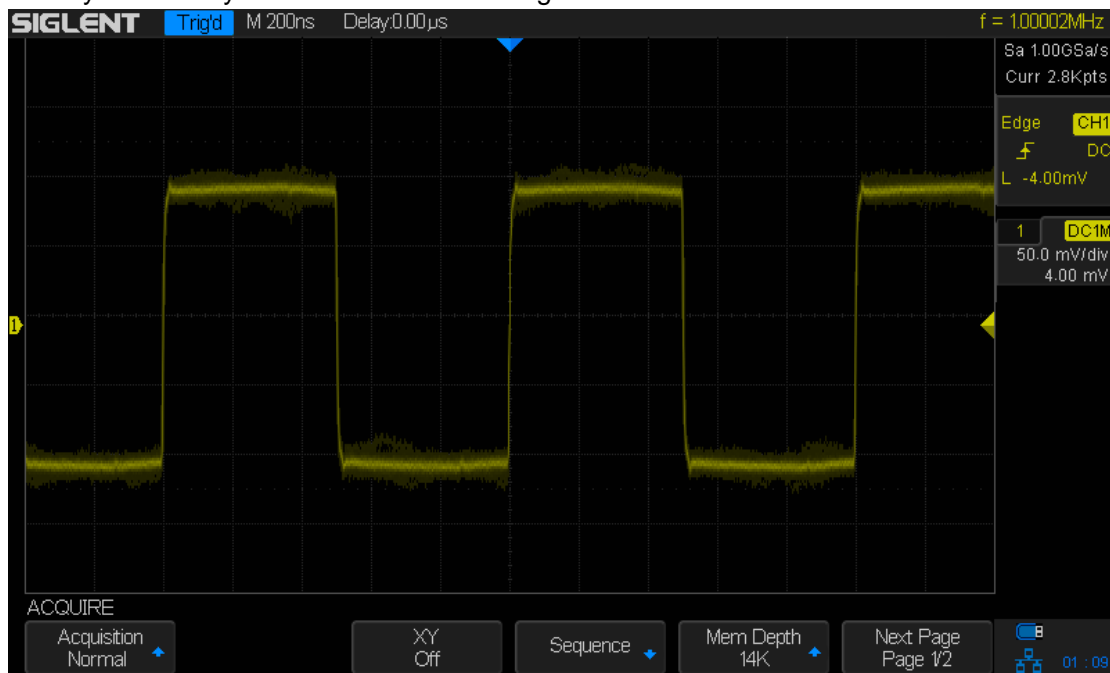

Figure 17: With Random Noise, Normal Mode

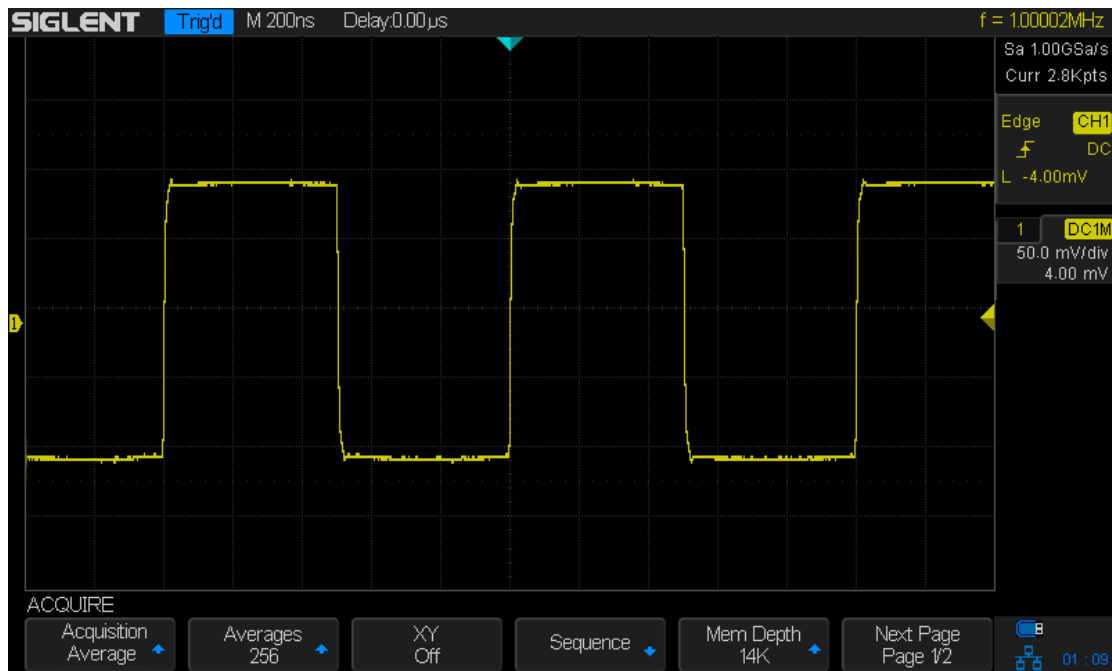

Figure 18: With Random Noise, Average Mode

## Eres (Enhanced Resolution)

This mode uses a digital filter to reduce the random noise on the input signal and generate much smoother waveforms on the screen.

Eres can be used on both single-shot and repetitive signals and it does not slow down waveform update. This mode limits the oscilloscope's real-time bandwidth because it effectively acts like a low-pass filter.



Figure 19: Eres Mode

## To Change the Horizontal Format

Press the **Acquire** button on the front panel; then press the **XY** softkey to set the XY (On) or YT (Off) mode. The default setup is **YT**.

### YT

It is the normal viewing mode for the oscilloscope. In the Normal time mode, signal events occurring before the trigger are plotted to the left of the trigger point and signal events after the trigger plotted to the right of the trigger point.

### XY

XY mode changes the display from a volt-versus-time display to a volt-versus-volt display. Channel 1 amplitude is plotted on the X-axis and Channel 2 amplitude is plotted on the Y-axis, the two channels will be turned on or off together.

XY mode can be used to compare frequency and phase relationships between two signals. It can also be used with transducers to display strain versus displacement, flow versus pressure, volts versus current, or voltage versus frequency.

The phase deviation between two signals with the same frequency can be easily measured via the Lissajous method. The figure below shows the measurement schematic diagram of the phase deviation

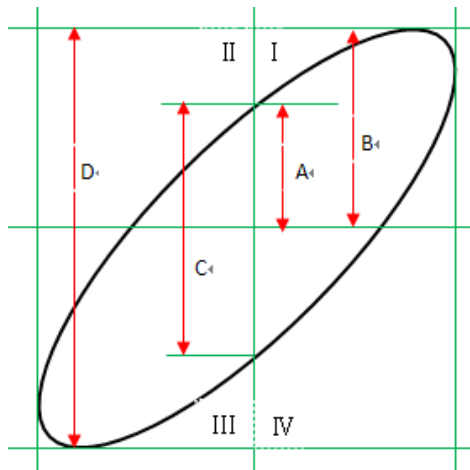

According to  $\sin\theta = A/B$  or  $C/D$  (wherein,  $\theta$  is the phase deviation angle between the two channels and the definitions of A, B, C and D are as shown in the figure above), the phase deviation angle is obtained, that is:  $\theta = \pm \arcsin (A/B)$  or  $\pm \arcsin (C/D)$

If the principal axis of the ellipse is within quadrant I and III, the phase deviation angle obtained should be within quadrant I and IV, namely within  $(0$  to  $\pi/2)$  or  $(3\pi/2$  to  $2\pi)$ . If the principal axis of the ellipse is within quadrant II and IV, the phase deviation angle obtained should be within quadrant II and III, namely within  $(\pi/2$  to  $\pi)$  or  $(\pi$  to  $3\pi/2)$ .

## Use Sequence Mode

The Sequence Mode does not display the waveform during the sampling process. This improves the waveform capture rate by focusing the instrument resources on sampling. This increases the waveform capture rate to about 500,000 wfm/s. The Sequence Mode increases the ability to capture events with small probability effectively.

The oscilloscope keeps running and filling data memory in segments for each trigger event, until the memory is full, and then display all the waveforms on the screen.

To use the sequence mode, the HORIZONTAL Format must be set to **YT**.

Do the following steps to use the sequence mode.

1. Press the **Acquire** button on the front panel to enter the ACQUIRE function menu;
2. Press the **Sequence** softkey to enter the SEQUENCE function menu.



Figure 20: SEQUENCE Function Menu

3. Press the **Segments Set** softkey; and then turn the **Universal Knob** to select the desired value.

Do the following steps to replay the sequence waveform under history mode:

1. Press the **History** softkey to enable the HISTORY function.

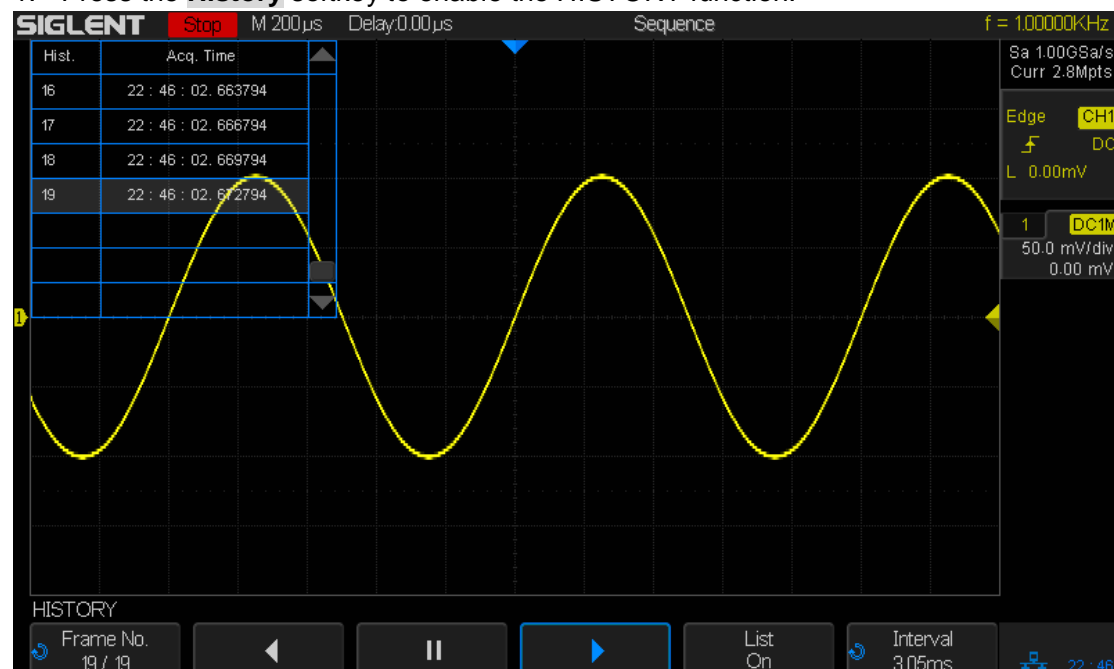





Figure 21: HISTORY Function Menu

2. Press the **List** softkey to turn on the list display. The list records the acquisition time of every frame and shows the frame number that displaying on the screen.
3. Press the **Frame No.** softkey; and then turn the **Universal Knob** to select the frame to

display.

4. Press the  softkey to replay the waveform from the current frame to 1.
5. Press the  softkey to pause the replay.
6. Press the  softkey to replay the waveform from the current frame to the last frame.

# To Trigger the Oscilloscope

To observe and measure elements of an input waveform, it is most useful to have a stable and reproducible image of that waveform. To accomplish this, many oscilloscopes feature a trigger model that enables you to specify certain conditions for the input signal (only trigger on the rising edge, for example). The input signal is evaluated according to these settings and when a waveform meets this condition, the oscilloscope captures it is displayed on the screen. Digital oscilloscopes can display the input waveform continuously without a stable trigger present. Only a stable trigger can ensure a stable display of the waveform. The trigger circuit ensures that every time base sweep or acquisition starts from the input signal and the user-defined trigger condition, namely every sweep is synchronous to the acquisition and the waveforms acquired overlap to display a stable waveform.

The following is the schematic diagram of the acquisition memory. As shown in the figure below, the position of the trigger event is determined by the reference time point and the delay setting.

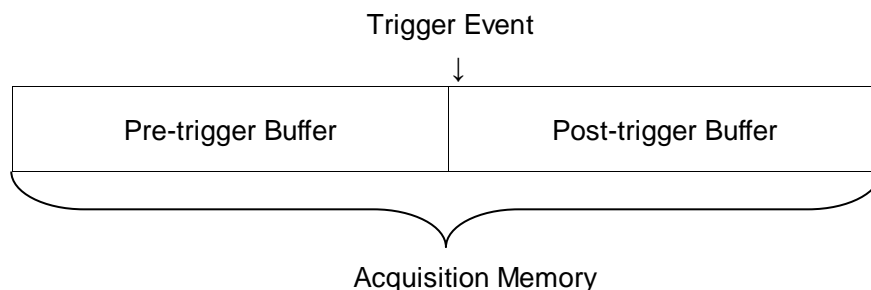

The trigger setting should be based on the type of signal characteristics of the input signal, thus a certain amount of knowledge about the signal-under-test is helpful in order to quickly capture the desired waveform.

SDS2000X provides abundant advanced trigger functions which can help you to focus on the desired waveform details. These trigger types are Edge, Slope, Pulse, Video, Window, Interval, Dropout, Runt, Pattern and Serial trigger. This chapter will introduce these trigger function types listed above in detail and explain how to set the trigger conditions in order to capture the desired waveform.

The contents of this chapter:

- ◆ [Trigger Source](#)
- ◆ [Trigger Mode](#)
- ◆ [Trigger Level](#)
- ◆ [Trigger Coupling](#)
- ◆ [Trigger Holdoff](#)
- ◆ [Noise Rejection](#)
- ◆ [Trigger Type](#)
  - [Edge Trigger](#)
  - [Slope Trigger](#)
  - [Pulse Trigger](#)
  - [Video Trigger](#)
  - [Window Trigger](#)
  - [Interval trigger](#)
  - [Dropout Trigger](#)
  - [Runt Trigger](#)
  - [Pattern Trigger](#)



## Trigger Source

SDS2000X trigger sources include analog channels (**CH1**, **CH2**, **CH3**, **CH4**), as well as external trigger inputs **EXT**, **EXT/5** and **AC Line**.

Press the **Setup** button on the front panel to enter the TRIGGER function menu; press the **Source** softkey and then turn the **Universal Knob** to select the desired trigger source.

The current trigger source is displayed at the upper right corner of the screen. Select channel with signal input as trigger source to obtain stable trigger.

### Analog channel input:

Signals input from analog channels **1~4** can all be used as the trigger source.

### External trigger input:

The external trigger source can be used to connect an external trigger signal to the EXT TRIG channel when all of the four channels are sampling data. The trigger signal (such as an external clock or a signal from the circuit to be tested) will be connected to **EXT** and **EXT/5** trigger source via the **[EXT TRIG]** connector. **EXT/5** trigger source attenuates the signal by a factor of 5. It extends the trigger level. You can set the trigger level within the range of the trigger level (between -8 div to +8 div).

### AC line:

The trigger signal is obtained from the AC power input of the oscilloscope. This type of trigger signal can be used to display the relationship between a signal of interest (such as illuminating device) and power (power supply device). For example, it is often used in the power industry to achieve a stable trigger when observing the waveform output from the transformer of a transformer substation.

Note: Select a stable channel waveform as the trigger source to stabilize the display.

## Trigger Mode

SDS2000X trigger modes include Auto, Normal and Single. The trigger mode affects the way in which the oscilloscope searches for the trigger

After the oscilloscope begins to capture data, the oscilloscope operates by first filling the pre-trigger buffer. It starts searching for a trigger after the pre-trigger buffer is filled and continues to flow data through this buffer while it searches for the trigger. While searching for the trigger, the oscilloscope overflows the pre-trigger buffer and the first data put into the buffer is first pushed out. This is also known as a First Input First Out, or FIFO buffer).

When/if a match for the given trigger condition is found, the pre-trigger buffer contains the events that occurred just before the trigger. Then, the oscilloscope fills the post-trigger buffer and displays the full acquisition memory.

Press the **Auto**, **Normal** or the **Single** buttons on the front panel to select the desired trigger mode, and the corresponding status light will be lighted.

- In the **Auto** trigger mode (the default setting), if the specified trigger conditions are not found, triggers are forced and acquisitions are made so that signal activity is displayed on the oscilloscope. The waveforms on the display may not be stable or repeatable in this case, but you should observe some portion of the waveforms.

The **Auto** trigger mode is appropriate when:

- Checking DC signals or signals with unknown levels or activity.
- When trigger conditions occur often enough that forced triggers are unnecessary.

- In the **Normal** trigger mode, triggers and acquisitions only occur when the specified trigger conditions are found. Otherwise, the oscilloscope holds the original waveform until the next trigger happens.

The **Normal** trigger mode is appropriate when:

- We only want to acquire specific events specified by the trigger settings.
- Triggering on an infrequent signal from a serial bus (for example, I2C, SPI, CAN, LIN, etc.) or another signal that arrives in bursts. The **Normal** trigger mode lets you stabilize the display by preventing the oscilloscope from auto-triggering and overwriting the current waveform with undesired data.

- In the Single trigger mode, the oscilloscope waits for a trigger and displays the waveform when the trigger condition is met and then stops acquiring data.

The **Single** trigger mode is appropriate in order:

- To capture single event or a periodic signal.
- To capture burst or other unusual signals.

## Trigger Level

Trigger level and slope define the trigger point,

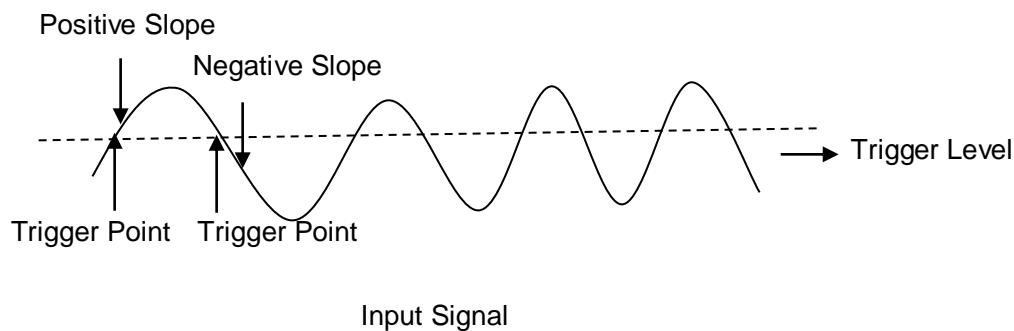

The trigger level can be adjusted for a selected analog channel by turning the **Trigger Level Knob**.

Push the **Trigger Level Knob** to set the level to the middle of the waveform. If AC coupling is used, pushing the **Trigger Level knob** sets the trigger level to approximately 0 V.

The position of the trigger level for the analog channel is indicated by the trigger level icon  (If the analog channel is on) at the left side of the display. The value of the analog channel trigger level is displayed in the upper-right corner of the display.

## Trigger Coupling

Press the **Setup** button on the front panel to enter the TRIGGER function menu, and then press the **Coupling** softkey and turn the **Universal Knob** or press the **Coupling** softkey continually to select the desired coupling mode.

SDS2000X provides 4 trigger coupling modes:

- **DC**: Allows DC and AC components into the trigger path.
- **AC**: Blocks all the DC components and attenuates signals lower than 8 Hz. Use AC coupling to get a stable edge trigger when your waveform has a large DC offset.
- **LF Reject**: Blocks the DC components and reject the low frequency components below 900 kHz. This setting also removes any unwanted low frequency components from a trigger waveform, such as power line frequencies, etc., that can interfere with proper triggering. Use **LF Reject** coupling to get a stable edge trigger when your waveform has low frequency noise.
- **HF Reject**: Rejects the high frequency components higher 500kHz

Note: Trigger coupling effects the trigger setting only. Channel coupling is a separate control.

## Trigger Holdoff

Trigger holdoff can be used to stabilize the triggering of complex waveforms (such as a pulse series). Holdoff time is the amount of time that the oscilloscope waits before re-arming the trigger circuitry. The oscilloscope will not trigger until the holdoff time expires.

Use the holdoff to trigger on repetitive waveforms that have multiple edges (or other events) between waveform repetitions. You can also use holdoff to trigger on the first edge of a burst when you know the minimum time between bursts.

For example, to get a stable trigger on the repetitive pulse burst shown below, set the holdoff time to be  $>200$  ns but  $<600$  ns.

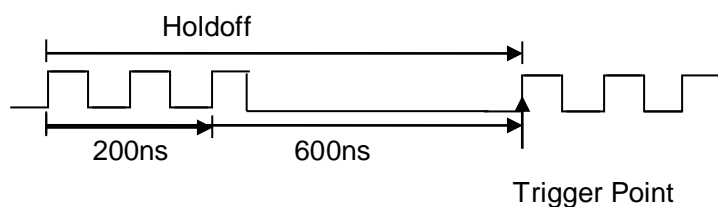

The correct holdoff setting is typically slightly less than one repetition of the waveform. Set the holdoff to this time to generate a unique trigger point for a repetitive waveform. Only edge trigger and serial triggers have the holdoff option. The holdoff time of SDS2000X is adjustable from 100ns to 1.5s.

1. Press the **Stop** button, and then use the **Horizontal Position Knob** and the **Horizontal Scale Knob** to find where the waveform repeats. Measure this time using cursors; then, set the holdoff.
2. Press the **Setup** button on the front panel to enter the TRIGGER function menu. The default trigger type is edge.
3. Press the **Holdoff Close** softkey; and then turn the **Universal Knob** to set the desired holdoff time.

Note: Adjusting the time scale and horizontal position will not affect the holdoff time.

## Noise Rejection

Noise Reject adds additional hysteresis to the trigger circuitry. By increasing the trigger hysteresis band, you reduce the possibility of triggering on noise. However, this also decreases the trigger sensitivity so that a slightly larger signal is required to trigger the oscilloscope.

Press the **Setup** button on the front panel, and then press the **Noise Reject** softkey continually to set the option to **On** or **Off** to turn on or off the noise rejection function.

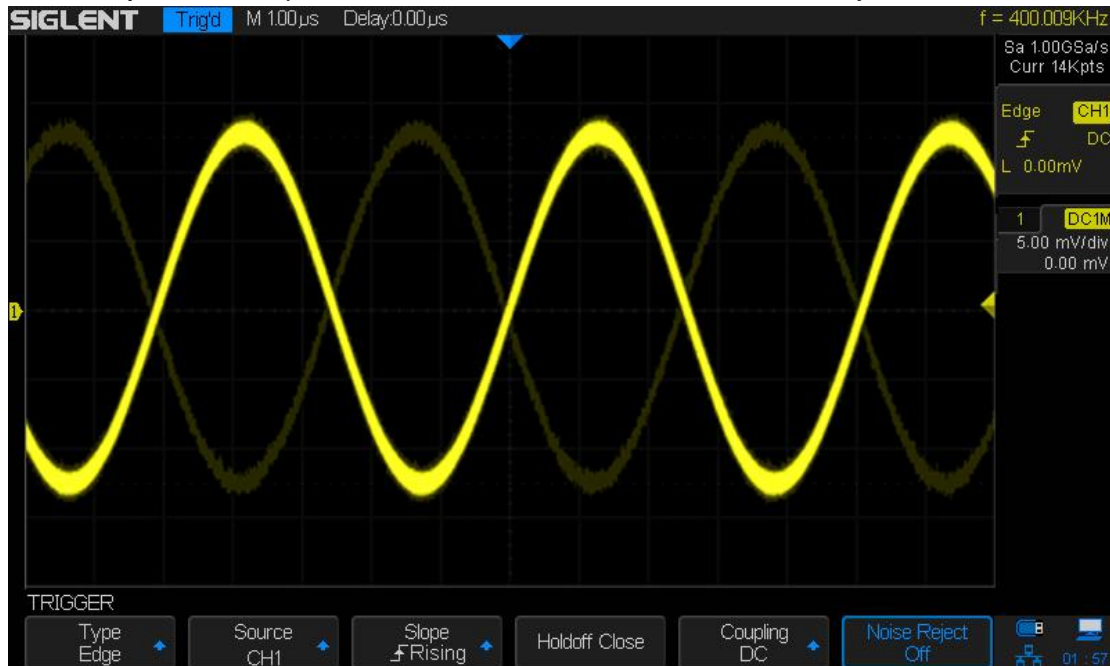

Figure 22: Turn off Noise Reject

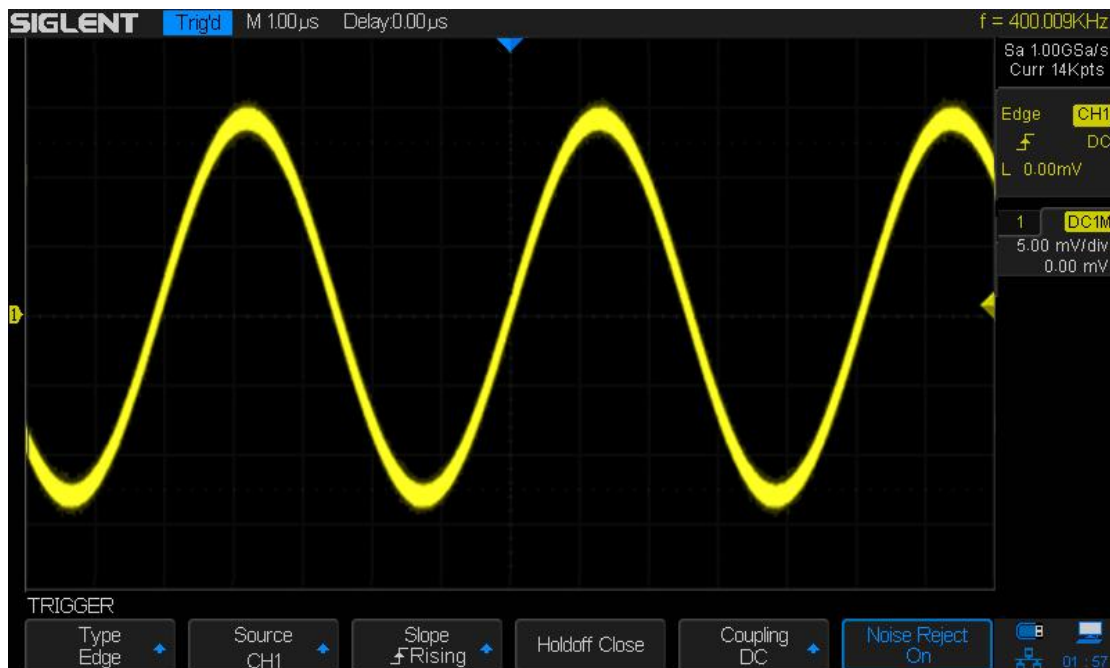

Figure 23: Turn on Noise Reject

If the signal you are probing is noisy, you can setup the oscilloscope to reduce the noise in the trigger path and on the displayed waveform. First, stabilize the displayed waveform by removing the noise from the trigger path. Second, reduce the noise on the displayed waveform.

1. Connect a signal to the oscilloscope and obtain a stable display.
2. Remove the noise from the trigger path by setting trigger coupling to **LF Reject**, **HF Reject** or turning on **Noise Reject**.
3. Set the **Acquisition** option to Average to reduce noise on the displayed waveform.

## Trigger Type

SDS2000X provides multiple advanced trigger functions, including various serial bus triggers.

- ◆ [Edge trigger](#)
- ◆ [Slope trigger](#)
- ◆ [Pulse trigger](#)
- ◆ [Video trigger](#)
- ◆ [Window trigger](#)
- ◆ [Interval trigger](#)
- ◆ [DropOut trigger](#)
- ◆ [Runt trigger](#)
- ◆ [Pattern trigger](#)



## Edge Trigger

Edge trigger distinguishes the trigger points by seeking the specified edge (rising, falling, rising & falling) and trigger level.

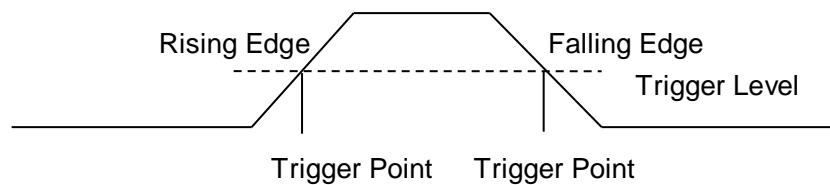

1. Press the **Setup** button on the front panel to enter the Trigger system function menu.
2. Press the **Type** softkey; turn the **Universal Knob** to set select **Edge** and then push the knob to confirm.
3. Press the **Source** softkey; turn the **Universal Knob** to select **CH1**, **CH2**, **CH3**, **CH4**, **EXT**, **EXT/5** or **AC Line** as the trigger source.
4. Press the **Slope** softkey; turn the **Universal Knob** to select the desired trigger edge (rising, falling or rising & falling), and then press down the knob to confirm. The current trigger slope is displayed at the upper right corner of the screen.
5. Turn the **Trigger Level Knob** to adjust the trigger level to obtain stable trigger.



Figure 24: Edge Trigger

Note: Press the **Auto Setup** button will set the trigger type to Edge and slope to rising.

## Slope Trigger

The slope trigger looks for a rising or falling transition from one level to another level in the specified time range.

In SDS2000X, positive slope time is defined as the time difference between the two crossing points of trigger level line A and B with the positive edge as shown in the figure below.

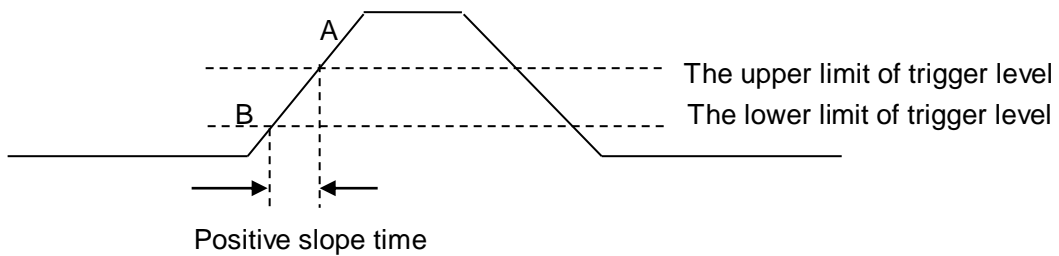

1. Press the **Setup** button on the front panel to enter the TRIGGER function menu.
2. Press the **Type** softkey; turn the **Universal Knob** to set select **Slop** and then push the knob to confirm.
3. Press the **Source** softkey; turn the **Universal Knob** to select CH1~4 as the trigger source.
4. Press the Slop softkey; turn the **Universal Knob** to set select the desired trigger edge (rising or falling), and then push down the knob to confirm. The current trigger slope is displayed at the upper right corner of the screen.



Figure 25: Slope Trigger

- 
5. Press the **Limit Range** softkey; then turn the **Universal Knob** to select the desired slope condition, and push down the knob to confirm.
    - **<** (less than a time value): Trigger when the positive or negative slope time of the input signal is lower than the specified time value.
    - **>** (greater than a time value): Trigger when the positive or negative slope time of the input signal is greater than the specified time value.
    - **[--,--]**(within a range of time value): Trigger when the positive or negative slope time of the input signal is greater than the specified lower limit of time and lower than the specified upper limit of time value.
    - **--][--]**(outside a range of time value): Trigger when the positive or negative slope time of the input signal is greater than the specified upper limit of time and lower than the specified lower limit of time value.
  
  6. Press the **Next Page** softkey and press of **Lower Upper** softkey to select **Lower** or **Upper** the trigger level; then turn the **Trigger Level Knob** to adjust the position. The trigger level values are displayed at the upper right corner of the screen.

The lower trigger level cannot be larger than the upper trigger level. In the trigger state message box, L1 indicates the upper trigger level while L2 indicates the lower trigger level.

## Pulse Trigger

Trigger on the positive or negative pulse with a specified width.

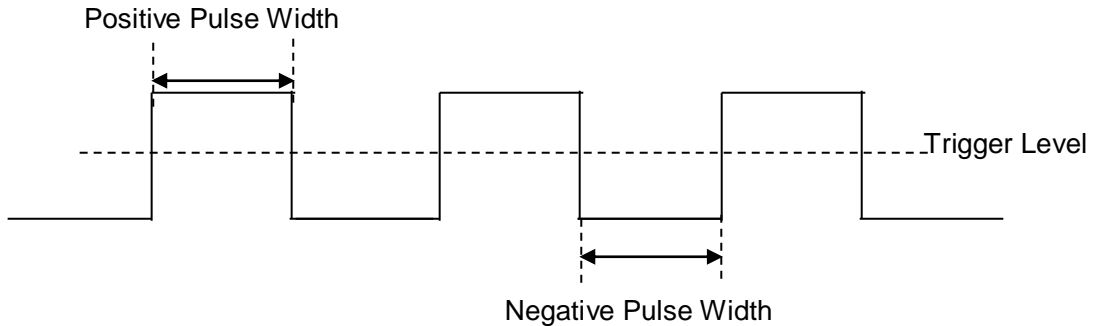

1. Press the **Setup** button on the front panel to enter the TRIGGER function menu.
2. Press the **Type** softkey; turn the **Universal Knob** to select **Pulse** and then push the knob to confirm.
3. Press the **Source** softkey; turn the **Universal Knob** to select CH1~4 as the trigger source.
4. Turn the **Trigger Level Knob** to adjust the trigger level to the desired place.
5. Press the **Polarity** softkey to select **Positive** or **Negative** pulse that to trigger on. The current trigger polarity is displayed at the upper right corner of the screen.
6. Press the **Limit Range** softkey; turn the **Universal Knob** to select the desired condition.

- < (less than a time value): Trigger when the positive or negative pulse time of the input signal is lower than the specified time value.

For example, for a positive pulse, if you set  $t$  (pulse real width)  $< 100\text{ns}$ , the waveform will trigger.



- > (greater than a time value): Trigger when the positive or negative pulse time of the input signal is greater than the specified time value.

For example, for a positive pulse, if you set  $t$  (pulse real width)  $> 100\text{ns}$ , the waveform will trigger.



- **[--,--]**(within a range of time value): Trigger when the positive or negative pulse time of the input signal is greater than the specified lower limit of time and lower than the specified upper limit of time value.

For example, for a positive pulse, if you set  $t$  (pulse real width)  $>100\text{ns}$  and  $t < 300\text{ns}$ , the waveform will trigger.

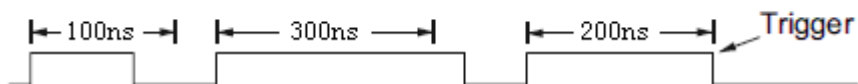

- **--][--]**(outside a range of time value): trigger when the positive or negative pulse time of the input signal is greater than the specified upper limit of time and lower than the specified lower limit of time value.

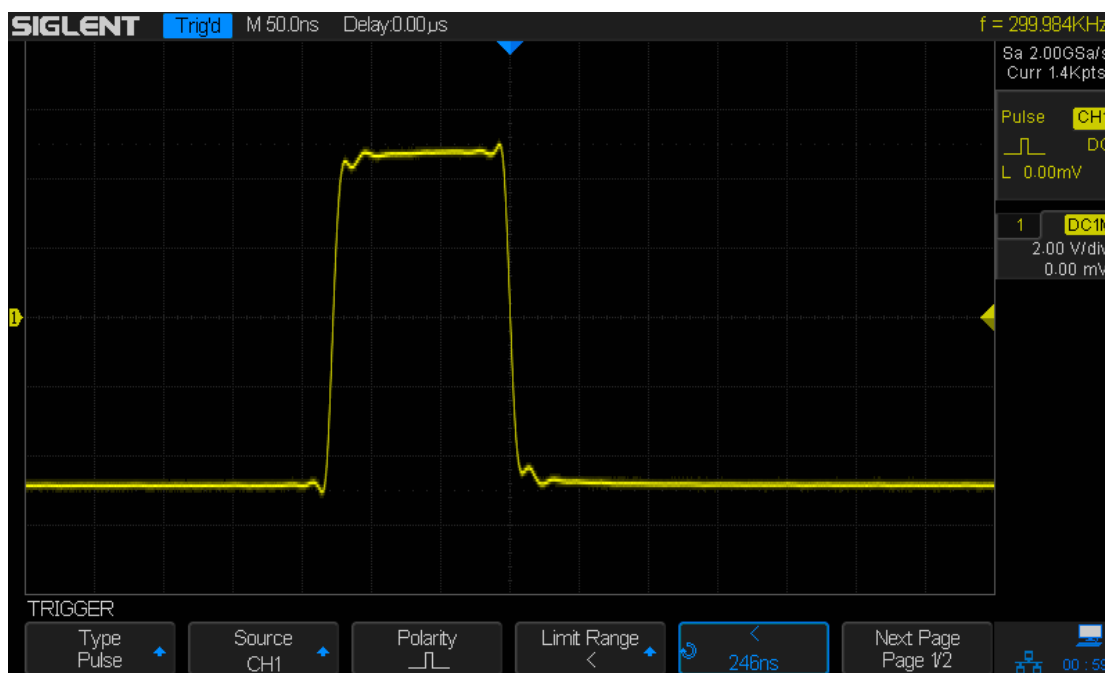

Figure 26: Pulse Trigger

## Video Trigger

Video triggering can be used to capture the complicated waveforms of most standard analog video signals. The trigger circuitry detects the vertical and horizontal interval of the waveform and produces triggers based on the video trigger settings you have selected. The SDS2000X supports standard video signals for NTSC (National Television Standards Committee), PAL (Phase Alternating Line) HDTV (High Definition Television) and custom video signal triggers.

1. Press the **Setup** button on the front panel to enter the TRIGGER function menu.
2. Press the **Type** softkey; then turn the **Universal Knob** to select **Video** and push down the knob to confirm.
3. Press the **Source** softkey; turn the **Universal Knob** to select CH1~4 as the trigger source. Turn the **Trigger Level Knob** does not change the trigger level because the trigger level is automatically set to the sync pulse.
4. Press the **Standard** softkey to select the desired video standard. SDS2000X supports the following video standards:

Standard	Type	Sync Pulse
NTSC	Interlaced	BI-level
PAL	Interlaced	BI-level
HDTV 720P/50	Progressive	Tri-level
HDTV 720P/60	Progressive	Tri-level
HDTV 1080P/50	Progressive	Tri-level
HDTV 1080P/60	Progressive	Tri-level
HDTV 1080i/50	Interlaced	Tri-level
HDTV 1080i/60	Interlaced	Tri-level
Custom		

The table below shows the parameters of the Custom video trigger.

Frame Rate	25 Hz, 30 Hz, 50 Hz, 60 Hz	
Of Lines	300~2000	
Of Fields	1, 2, 4, 8	
Interlace	1:1, 2:1, 4:1, 8:1	
Trigger Position	Line	Field
	(line value)/1	1
	(line value)/2	2
	(line value)/3	3
	(line value)/4	4
	(line value)/5	5
	(line value)/6	6
	(line value)/7	7
	(line value)/8	8

The table below takes **Of Lines** as 800 as an example to explain the relation between **Of Lines, Of Fields, Interlace, Trigger Line** and **Trigger Field**.

Of Lines	Of Fields	Interlace	Trigger Line	Trigger Field
800	1	1:1	800	1
800	1,2,4 or 8	2:1	400	1, 1~2, 1~4, 1~8
800	1,2,4 or 8	4:1	200	1, 1~2, 1~4, 1~8
800	1,2,4 or 8	8:1	100	1, 1~2, 1~4, 1~8

- Press the **Sync** softkey to select **Any** or **Select** trigger mode.
  - Any:** Trigger on any of the horizontal sync pulses
  - Select:** Trigger on the appointed line and field you have set. Press the Line or Field softkey; then turn the **Universal Knob** to set the value.

The following table lists the line numbers per field for each video standard:

Standard	Field 1	Field 2
NTSC	1 to 262	1 to 263
PAL	1 to 312	1 to 313
HDTV 720P/50, HDTV 720P/60	1 to 750	
HDTV 1080P/50, HDTV 1080P/60	1 to 1125	
HDTV 1080iP/50, HDTV 1080i/60	1 to 562	1 to 563

The following are exercises to familiarize you with video triggering:

- To trigger on a specific line of video
- To use Custom video trigger

### To Trigger on a Specific Line of Video

Video triggering requires greater than 1/2 division of sync amplitude with any analog channel as the trigger source.

The example below set to trigger on field 2, line 124 using the NTSC video standard.

- Press the **Setup** button on the front panel to enter the TRIGGER system function menu.
- Press the **Type** softkey; then use the **Universal Knob** to select Video and push down the knob to confirm.
- Press the **Source** softkey; turn the Universal Knob to select CH1 as the trigger source, and press the knob to confirm.
- Press the **Standard** softkey; turn the Universal Knob to select NTSC, and press the knob to confirm.
- Press the **Sync** softkey and set the option to **Select**; press the **Line** softkey and then turn the universal to select **022** and push the knob to confirm; press the **Field** softkey and then turn the **Universal Knob** to select **1** and push the knob to confirm

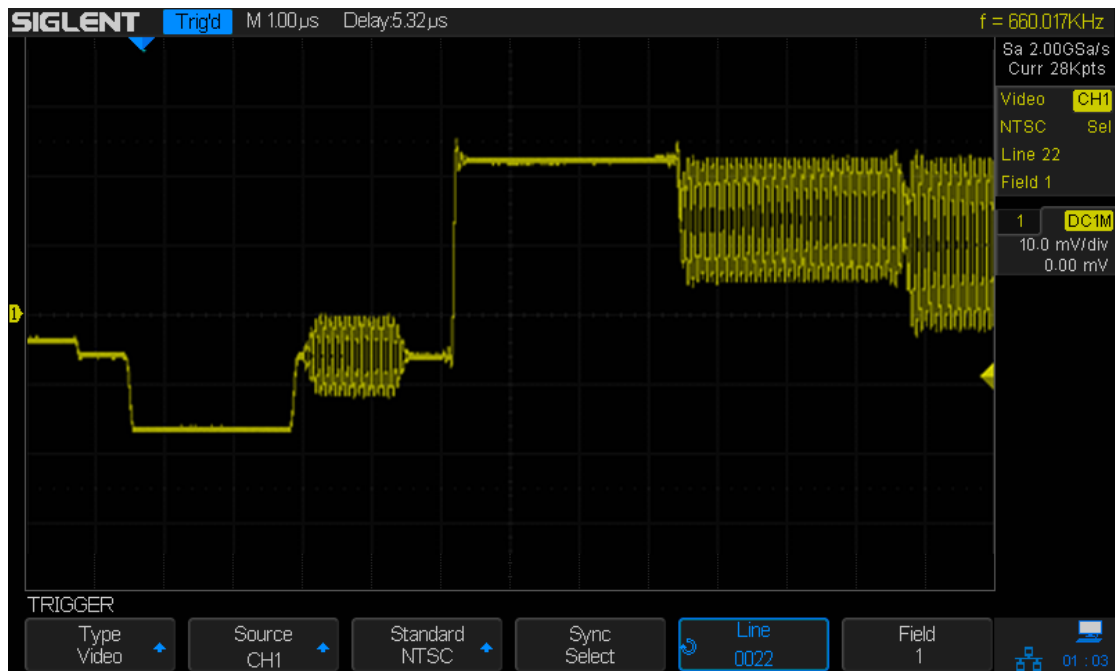

Figure 27: Video Trigger

### To Use Custom Video Trigger

Custom video trigger supports frame rates of 25Hz, 30Hz, 50Hz and 60Hz, and the line range is available from 300 to 2000. The steps below show how to set custom trigger.

1. Press the **Setup** button on the front panel to enter the TRIGGER function menu.
2. Press the **Type** softkey; then use the **Universal Knob** to select **Video** and push down the knob to confirm.
3. Press the **Source** softkey; turn the **Universal Knob** to select **CH1** as the trigger source, and push down the knob to confirm.
4. Press the **Standard** softkey; turn the **Universal Knob** to select **Custom**, and push down the knob to confirm.
5. Press the **Setting** softkey to enter the custom setting function menu. Press the **Interlace** softkey; turn the **Universal Knob** to select the desired value.
6. Press the **Of Field** softkey; turn the **Universal Knob** to select the desired value.
7. Press the **Sync** softkey to enter the TRIG ON menu to set the line and field.
  - Press the Type softkey to select or **Any**.
  - If the **Type** option set to **Select**, press the Line softkey; turn the **Universal Knob** to select the desired value. Press the **Field** softkey; turn the **Universal Knob** to select the desired value.



## Window Trigger

The window trigger provides a high trigger level and a low trigger level. The instrument triggers when the input signal passes through the high trigger level or the low trigger level.

There are two kinds of window types; Absolute and Relative. They have different trigger level adjustment methods. Under Absolute window type, the lower and the upper trigger levels can be adjusted respectively via the Level knob; under Relative window type, adjust the Center value to set the window center; adjust the Delta value to set the window range, the lower and the upper trigger levels always move together.

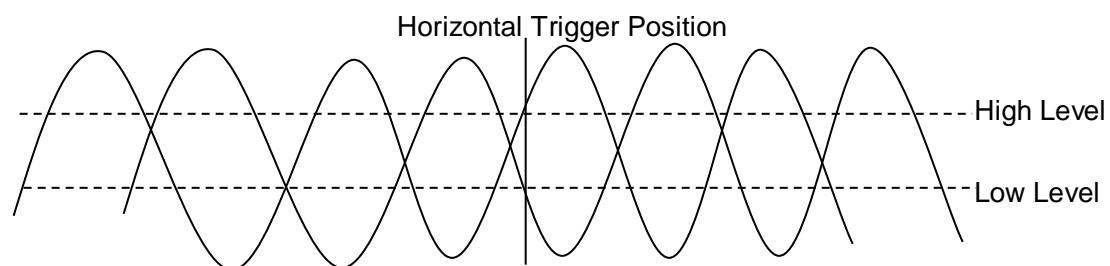

- If the lower and the upper trigger levels are both within the waveform amplitude range, the oscilloscope will trigger on both rising and falling edge.
- If the upper trigger level is within the waveform amplitude range while the lower trigger level is out of the waveform amplitude range, the oscilloscope will trigger on rising edge only.
- If the lower trigger level is within the waveform amplitude range while the upper trigger level is out of the waveform amplitude range, the oscilloscope will trigger on falling edge only.

### To set window trigger via Absolute window type:

1. Press the **Setup** button on the front panel to enter the TRIGGER function menu.
2. Press the **Type** softkey; then use the **Universal Knob** to select **Window** and push down the knob to confirm.
3. Press the **Source** softkey; turn the **Universal Knob** to select CH1~4 as the trigger source.
4. Press the Window **Type** softkey to select Absolute.
5. Press the **Lower Upper** softkey to select **Lower** or **Upper** trigger level; then turn the **Trigger Level Knob** to adjust the position. The trigger level values are displayed at the upper right corner of the screen.

The Lower trigger level cannot be upper than the upper trigger level. In the trigger state message box, **L1** means the upper trigger level while **L2** means the lower trigger level.

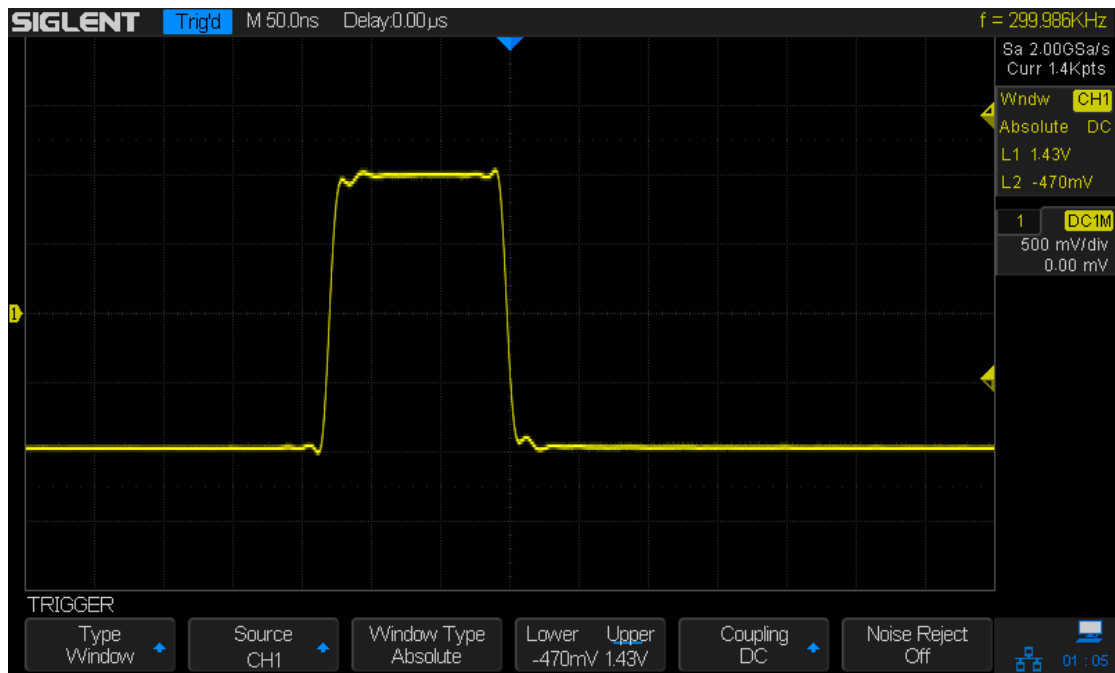

Figure 28: Absolute Window Trigger

#### To set window trigger via Relative window type:

1. Press the **Setup** button on the front panel to enter the TRIGGER system function menu.
2. Press the **Type** softkey; then use the **Universal Knob** to select **Window** and push down the knob to confirm.
3. Press the **Source** softkey; turn the **Universal Knob** to select CH1~4 as the trigger source.
4. Press the **Window Type** softkey to select **Relative**.
5. Press the **Center Delta** softkey to select **Center** or **Delta** trigger level mode; then turn the **Trigger Level Knob** to adjust the position. The **Center** and **Delta** values are displayed at the upper right corner of the screen.

In the trigger state message box, **C** means **Center**, the center value of the lower and upper trigger levels; **D** means **Delta**, the difference between the lower (or upper) trigger level and the trigger level center.

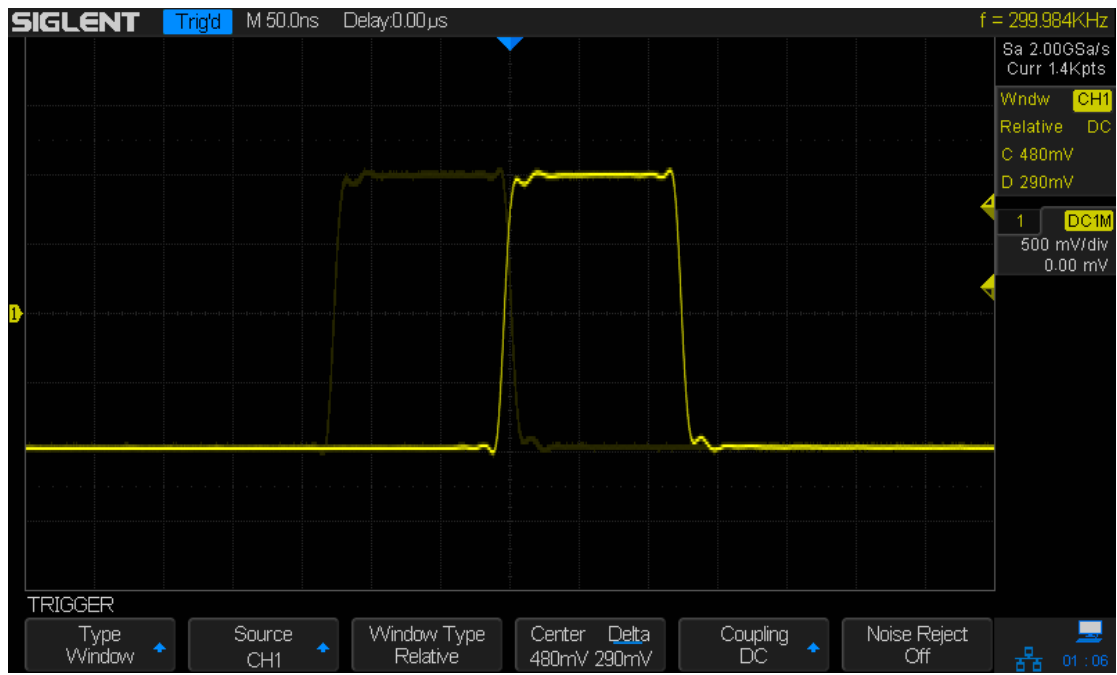
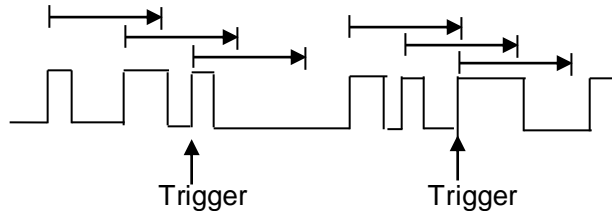

Figure 29: Relative Window Trigger

## Interval Trigger

Trigger when the time difference between the neighboring rising or falling edges meets the time limit condition (<, >, [--,--], --][--).



To set interval trigger:

1. Press the **Setup** button on the front panel to enter the TRIGGER system function menu.
2. Press the **Type** softkey; then use the **Universal Knob** to select **Interval** and push down the knob to confirm.
3. Press the **Source** softkey; turn the **Universal Knob** to select CH1~4 as the trigger source.
4. Press the **Slope** softkey to select rising or falling edge.
5. Press the **Limit Range** softkey; turn the **Universal Knob** to select desired condition.
  - < (less than a time value): Trigger when the positive or negative pulse time of the input signal is less than the specified time value.
  - > (greater than a time value): Trigger when the positive or negative pulse time of the input signal is greater than the specified time value.
  - [--,--](within a range of time value): Trigger when the positive or negative pulse time of the input signal is greater than the specified lower limit of time and less than the specified upper limit of time value.
  - --][--(outside a range of time value): Trigger when the positive or negative pulse time of the input signal is greater than the specified upper limit of time and less than the specified lower limit of time value.
6. Press the **Time Setting** softkey (<, >, [--,--], --][--), turn the **Universal Knob** to select the desired value.

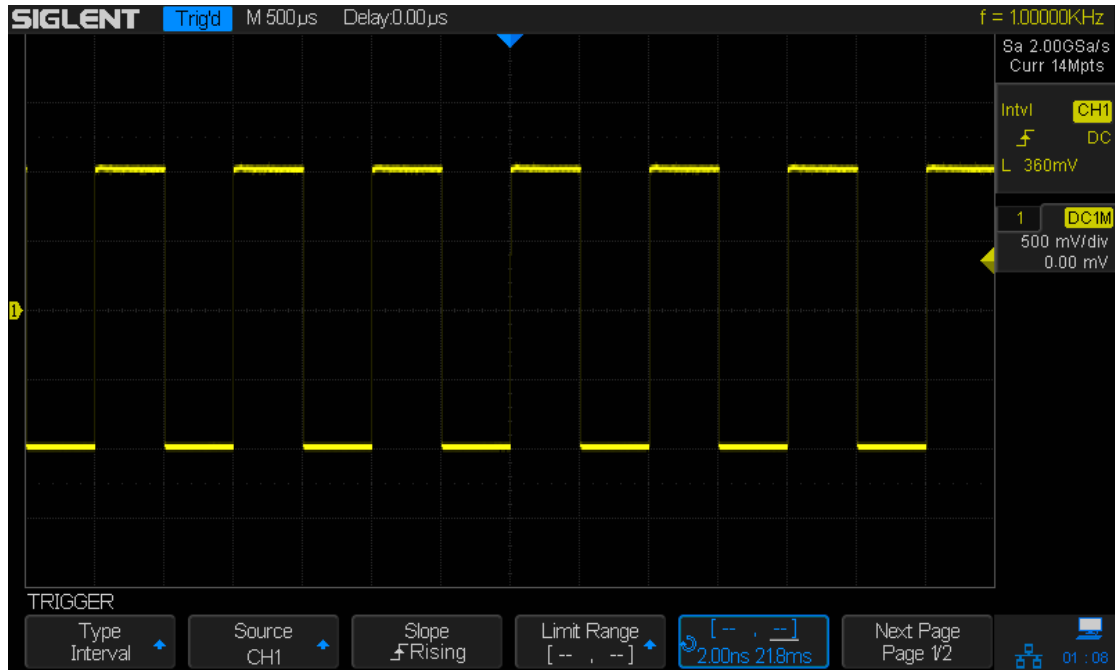

Figure 30: Interval Trigger

## DropOut Trigger

DropOut trigger includes two types: Edge and state.

### Edge

Trigger when the time interval ( $\Delta T$ ), measured from when the rising edge (or falling edge) of the input signal passes through the trigger level to when the neighboring rising edge (or falling edge) passes through the trigger level, is greater than the timeout time set, as shown in the figure below.

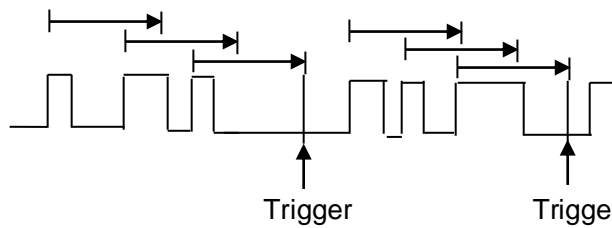

### State

Trigger when the time interval ( $\Delta T$ ), measured from when the rising edge (or falling edge) of the input signal passes through the trigger level to when the neighboring falling edge (or rising edge) passes through the trigger level, is greater than the timeout time set, as shown in the figure below.

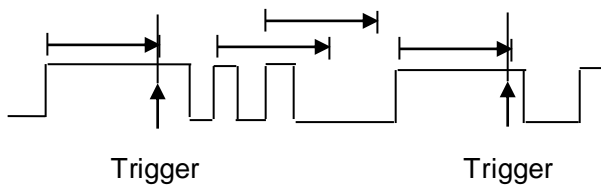

To set edge DropOut trigger:

1. Press the **Setup** button on the front panel to enter the TRIGGER system function menu.
2. Press the **Type** softkey; then use the **Universal Knob** to select **DropOut** and push down the knob to confirm.
3. Press the **Source** softkey; turn the **Universal Knob** to select CH1~4 as the trigger source. The current trigger source is displayed at the upper right corner of the screen. Select channel with signal input as trigger source to obtain stable trigger.
4. Press the **Slope** softkey to select rising or falling edge.
5. Press the **OverTime Type** softkey to select **Edge**.
6. Press the **Time** softkey; turn the universal to select the desired value.

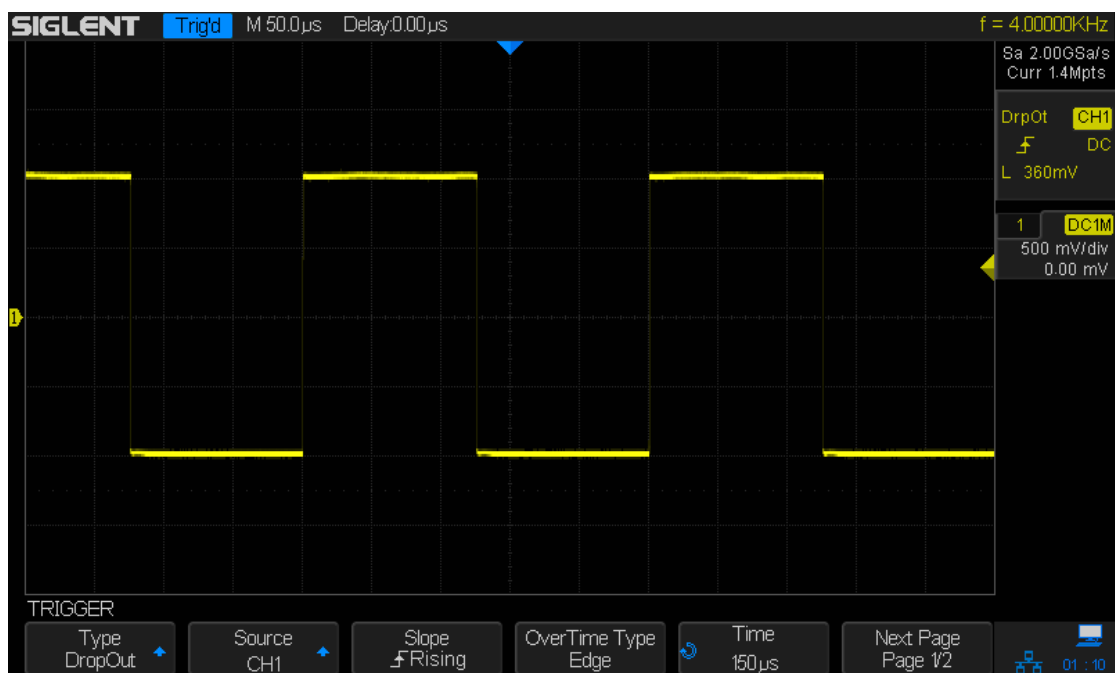

Figure 31: Edge DropOut Trigger

To set state DropOut trigger:

1. Press the **Setup** button to enter the TRIGGER system function menu.
2. Press the **Type** softkey; then turn the **Universal Knob** to select **DropOut** and push down the knob to confirm.
3. Press the **Source** softkey; turn the **Universal Knob** to select CH1~4 as the trigger source.
4. Press the **Slope** softkey to select rising or falling edge.
5. Press the **OverTime** Type softkey to select State.
6. Press the **Time** softkey; turn the **Universal Knob** to select the desired value.

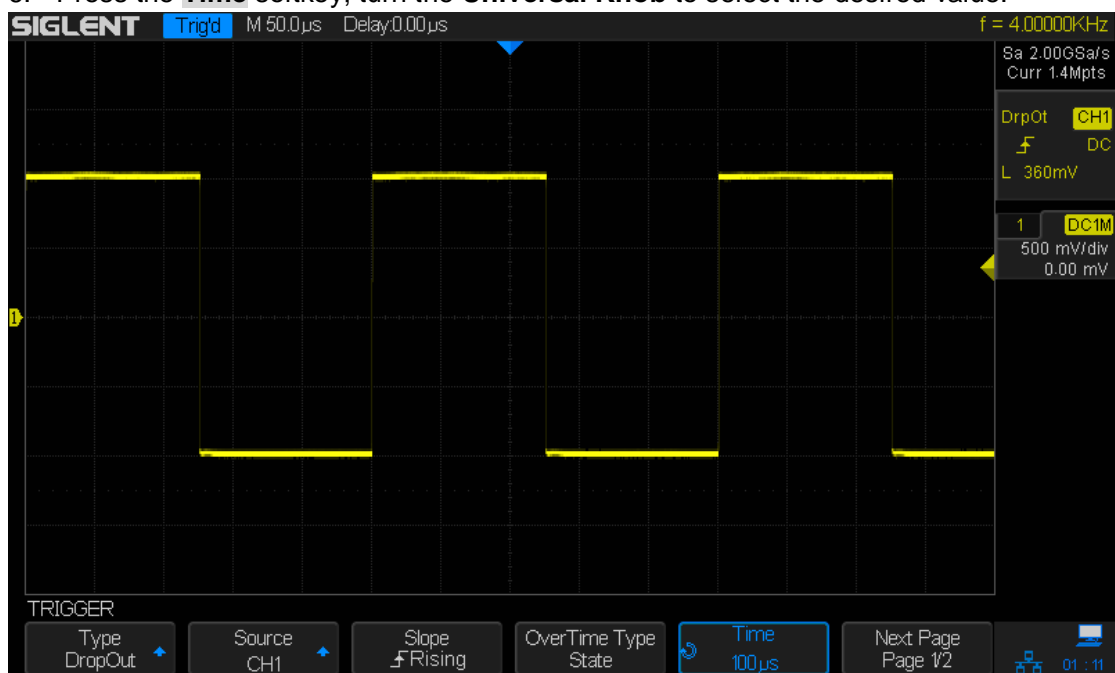
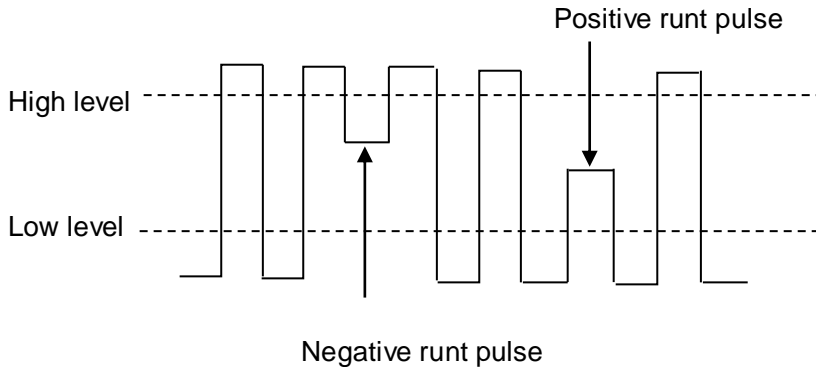

Figure 32: State DropOut Trigger

## Runt Trigger

The Runt trigger looks for pulses that cross one threshold but not another as shown in the picture below.



- A positive runt pulse across through a lower threshold but not an upper threshold.
- A negative runt pulse across through an upper threshold but not a lower threshold.

To trigger on runt pulse:

1. Press the **Setup** button on the front panel to enter the **TRIGGER** system function menu.
2. Press the **Type** softkey; then turn the **Universal Knob** to select **DropOut** and push down the knob to confirm.
3. Press the **Source** softkey; turn the **Universal Knob** to select CH1~4 as the trigger source.
4. Press the **Polarity** softkey to select **Positive** or **Negative** pulse to trigger.
5. Press the **LimitRange** softkey; turn the **Universal Knob** to select the desired condition (<, >, [--,--] or --][--).
6. Press the **Time Setting** softkey, and then turn the **Universal Knob** to select the desired value.
7. Press the **Next Page** softkey to enter the second page of the TRIGGER system function menu. Press the **Lower Upper** softkey to select **Lower** or **Upper** trigger level, and then turn the **Universal Knob** to set the position.



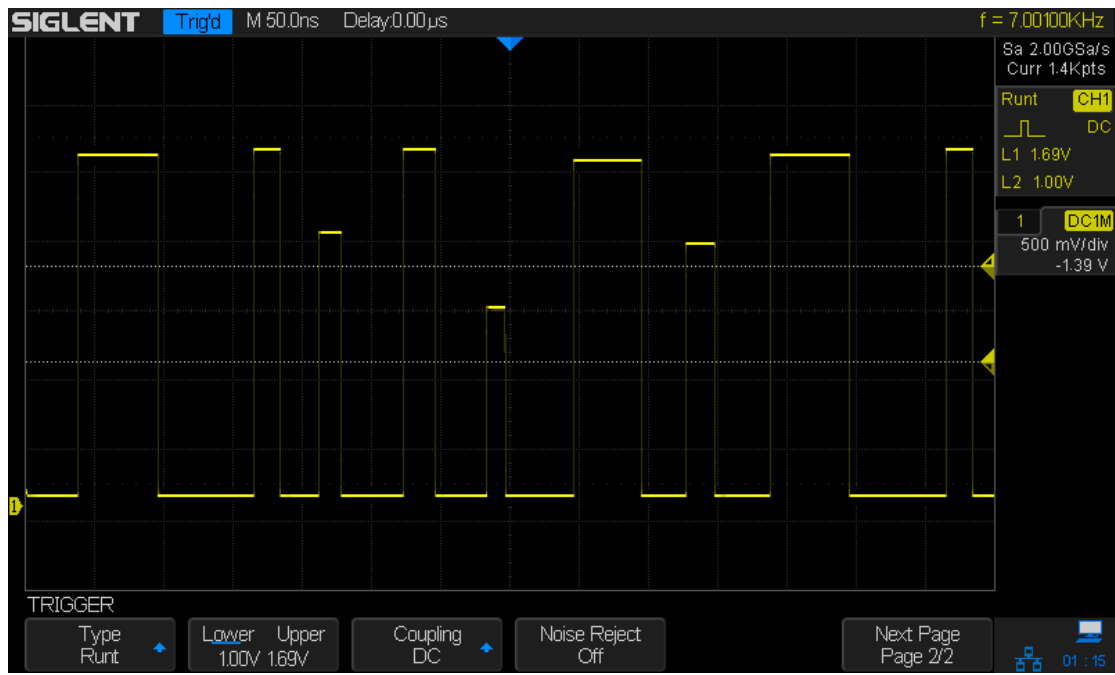
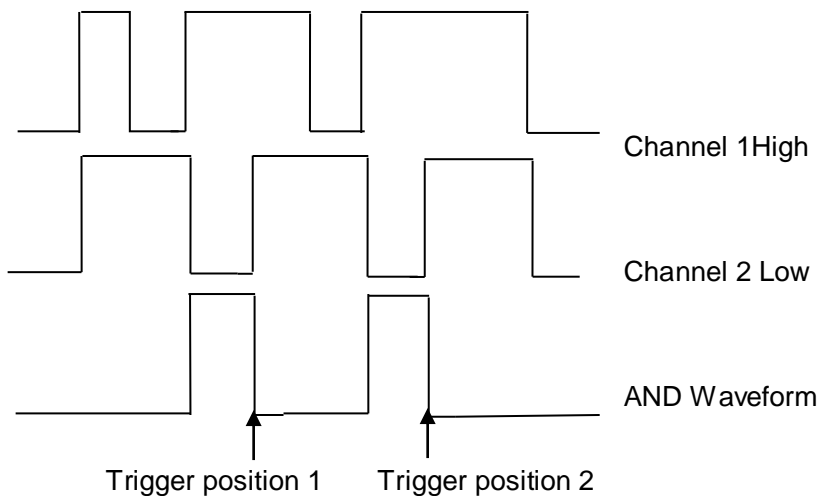

Figure 33: Runt Trigger

## Pattern Trigger

The Pattern trigger identifies a trigger condition by looking for a specified pattern. The pattern trigger can be expanded to incorporate delays similar to other triggers. Pattern durations are evaluated using a timer. The timer starts on the last edge that makes the pattern “true”. Potential triggers occur on the first edge that makes the pattern false, provided that the time qualifier criterion has been met. The SDS2000X provides 4 patterns: logical AND, OR, NAND and NOR combination of the channels. Each channel can set to low, high or invalid.



Do the following steps to set pattern trigger:

1. Press the **Setup** button on the front panel to enter the TRIGGER function menu.
2. Press the **Type** softkey; turn the **Universal Knob** to select Pattern, and then push down the knob to confirm.
3. Press each channel softkey to select **Invalid**, **High** or **Low**.
  - **Low** sets the pattern to low on the selected channel. A low is a voltage level that is less than the channel's trigger or threshold level.
  - **High** sets the pattern to high on the selected channel. A high is a voltage level that is greater than the channel's trigger or threshold level.
  - **Invalid** sets the pattern to “don't care” on the selected channel. Any channel set to “don't care” is ignored and is not used as part of the pattern. However, if all channels in the pattern are set to **Invalid**, the oscilloscope will not trigger. Adjust the trigger level for the selected analog channel by turning the Trigger Level knob. **Invalid** doesn't require a set trigger level.
4. Press the **Next Page** softkey to enter the second page of the pattern trigger menu.
5. Press the **Logic** softkey and then turn the **Universal Knob** to select the desired logic combination **AND**, **OR**, **NAND** or **NOR**.
6. Press the **Limit Range** softkey; then turn the **Universal Knob** to select the desired option.
  - **<(Less Than)** – when the pattern is present for less than a time value.

- **>(Greater Than)** – When the pattern is present for greater than a time value. The trigger occurs
  - **[--,--](In Range)** – When the pattern is present for a time within a range of values.
  - **--][-- (Out of Range)** – When the pattern is present for a time outside of the range of values.
7. Press the **Holdoff Close** softkey to turn on the Holdoff function; then turn the **Universal Knob** to select the desired value.

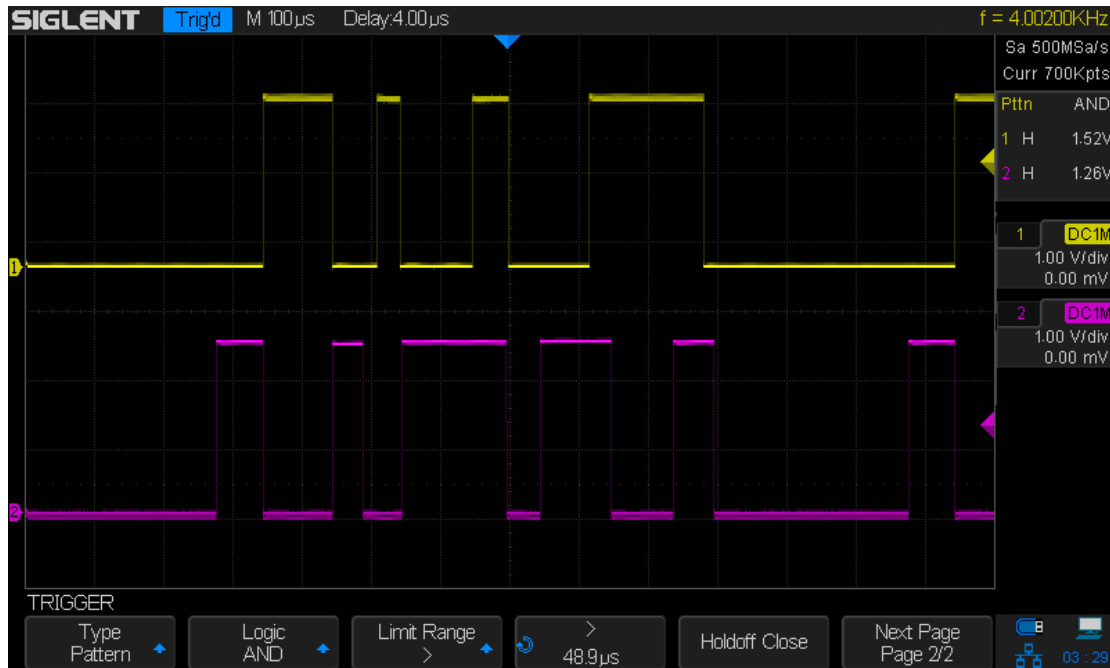

Figure 34: Pattern Trigger

# Serial trigger and decode

The oscilloscope provides IIC, SPI, UART/RS232, CAN and LIN serial trigger and decoding capabilities. This chapter introduces the method of triggering and decoding these serial signals in detail.

The contents of this chapter:

- ◆ [IIC Trigger and Serial Decode](#)
- ◆ [SPI Trigger and Serial Decode](#)
- ◆ [UART/RS232 Trigger and Serial Decode](#)
- ◆ [CAN Trigger and Serial Decode](#)
- ◆ [LIN Trigger and Serial Decode](#)

## IIC Trigger and Serial Decode

The following section describes trigger and decoding for the IIC bus and is organized as follows: “**Setup for IIC Signals**”, “**IIC Triggering**” and “**IIC Decode**”.

### Setup for IIC Signals

Setting the IIC (Inter-IC bus) signal includes two steps: Connecting the serial data signal (SDA) and serial clock signal (SCK) to oscilloscope, specifying the threshold voltage of each input signal.

1. Press **Decode** key to enter the **DECODE** function menu as Figure 35 shows.



Figure 35: IIC SINGAL Menu

2. Press the **Decode** softkey and select the desired slot (Decode1 or Decode2).
3. Press **Protocol** softkey and then select **IIC** by turning Universal Knob.
4. Press **Signal** softkey to enter the **SIGNAL** menu as Figure 36 shows.



Figure 36: IIC SIGNAL Menu

5. Set SCL (IIC’s clock signal):
  - a. Press **SCL** softkey to select the channel that is connected to the IIC clock signal.
  - b. Press first **Threshold** softkey to set the IIC clock signal threshold voltage level by the Universal Knob. The threshold voltage level is for decoding, and it will be regarded as the trigger voltage level when set the trigger type to serial.
6. Set SDA (IIC’s data signal):
  - a. Press **SDA** to select the channel that is connected to the IIC data signal.
  - b. Press the second **Threshold** softkey to select the IIC data signal threshold voltage and then set the level by using the Universal Knob. The threshold voltage level is for decoding, and it will be regarded as the trigger voltage level when the

trigger type is set to serial.

(**Tip:** The SDA should be stable during the whole high clock cycle, otherwise it will be interpreted as a start or stop condition (data transitioning while the clock is high).)

7. Press  softkey to return previous menu.
8. Press **Address** softkey and select the length of the IIC signal address (7 bits or 10 bits).

## IIC Triggering

This part introduces the nine kinds of trigger conditions (Start, Stop, Restart, No Ack, EEPROM, 7 Addr&Data, 10 Addr&Data and Data Length) and the methods of setting them.

### To introduce the trigger conditions

- **Start Condition**— The oscilloscope will be triggered when the SDA signal transitions from high to low while the SCL clock is high. If it is chosen as the condition of trigger (including frame triggers), a restart will be treated as a “Start condition”.
- **Stop Condition**— The oscilloscope will be triggered when the SDA transitions from low to high while the SCL is high.

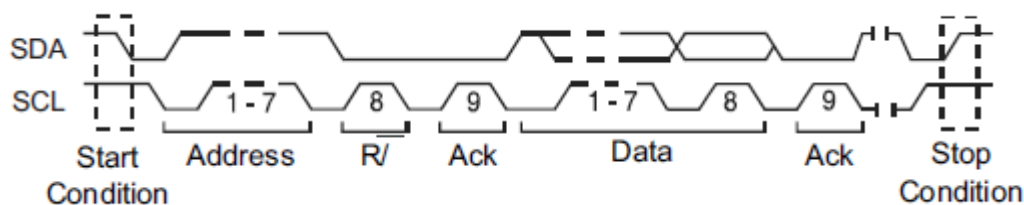

- **Restart**— The oscilloscope will be triggered when another “Start condition” occurs before a “Stop condition”.
- **No Ack**— The oscilloscope will be triggered when SDA data is high during any SCL’s ACK bit.
- **EEPROM** — The trigger searches for an EEPROM control byte (the value is 1010xxx) on the SDA bus, there is a Read bit, and an ACK bit behind EEPROM. Use the **Limit Range** softkey to set the qualifier and **Data1** softkey to set the data’s value. If the EEPROM’s data is greater(less than, or equal) than Data1, the oscilloscope will be triggered at the edge of ACK bit behind the Data byte. It’s not necessary that the Data byte must follow the EEPROM.

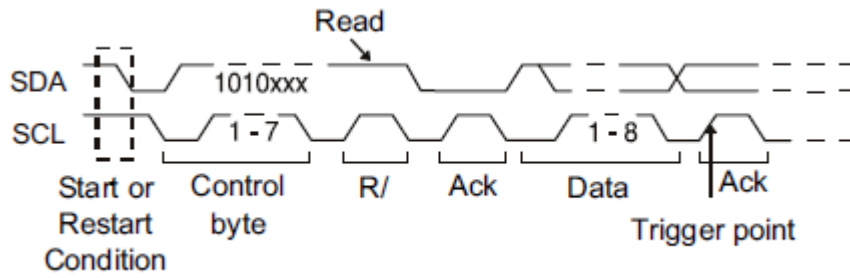

- **7 Address & Data** — The oscilloscope will be triggered when the following conditions are satisfied.

- The address's length must be 7 bits and the address's value is the same as the set value.
- If you have set either Data1's or Data2's value, and the signal has a data is the same as that value. If you have set both Data1's and Data2's value, the signal should have two consecutive data packets, the first packet is Data1, and the second is Data2.

(Note: If the data's value is 0xXX, any data value will be matched)

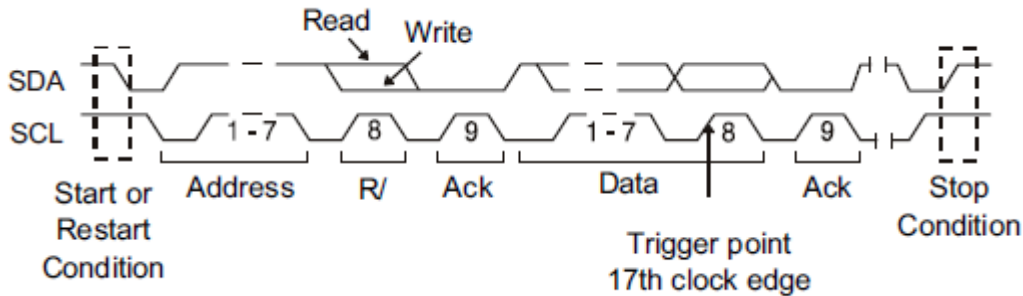

On the 17th Clock Edge

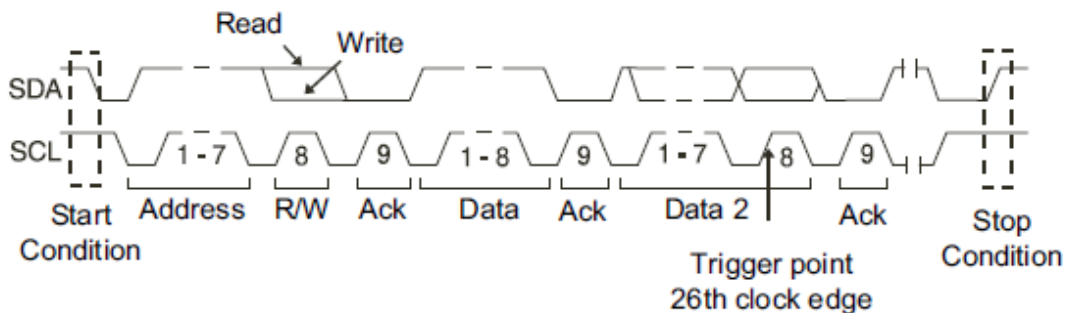

On the 26th Clock Edge



- **10 Address & Data** — The oscilloscope will be triggered when the following conditions are satisfied.
  - The address's length must be 10 bits and the address's value is the same as the set value.
  - If you have set either Data1's or Data2's value, and the signal has a data is the same as that value. If you have set both Data1's and Data2's value, the signal should have two consecutive data packets, the first is Data1, and the second is Data2.

(**Note:** If the set value is 0xXX, any data value will be matched)

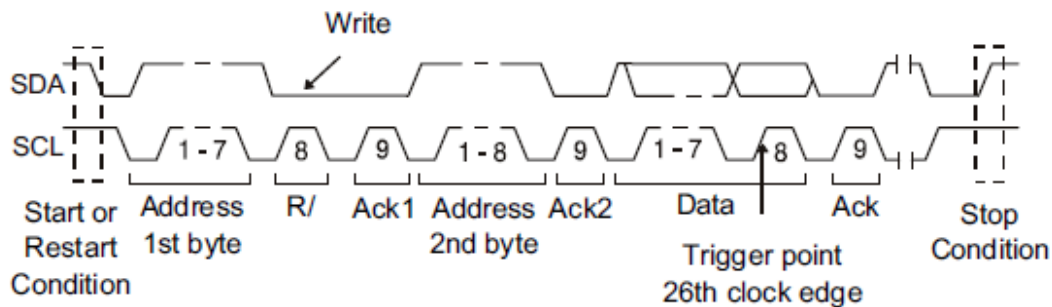

- **Data Length** — When the SDA data length is equal to the value of Byte Length and address's length is the same as the set value, the oscilloscope will be triggered. Byte length is in the range of 1 to 12 bits.

## Operation steps:

1. Press **Setup** to enter the **TRIGGER** function menu.
2. Press **Type** and select **Serial**.
3. Press **Protocol** and select **IIC**.
4. Press **Trigger Setting** softkey.

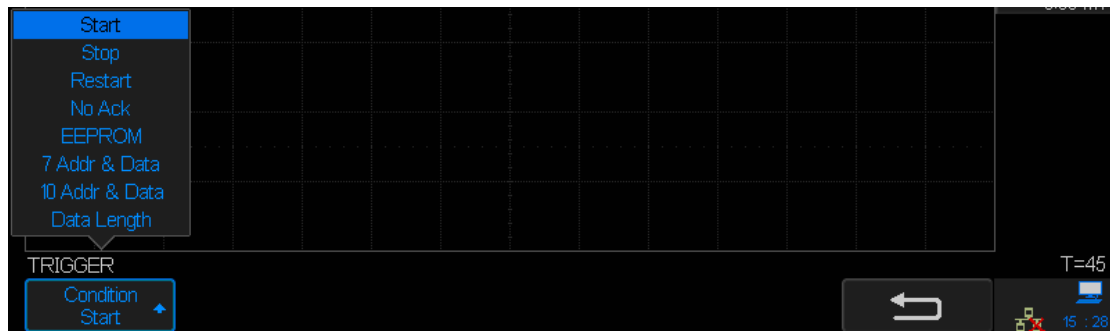

Figure 37: IIC TRIGGER Menu

5. Press the **Condition** softkey and turn the Universal Knob to select the trigger condition:
  - If you select the **EEPROM** condition:
    - a. Press the **Limit Range** softkey to set the qualifier (=, < or >).
    - b. Press **Data1** softkey and set its value by turning the Universal Knob.
  - If you select **7 Addr&Data** or **10 Addr&Data** condition:
    - a. Press the **Addr** softkey and turn the Universal Knob to select the 7-bit or 10-bit device address.
    - b. Press the **Data1** or **Data2** softkey and set the value about them.
    - c. Press the **R/W bit** softkey and select write-frame or read-frame to trigger the oscilloscope.

(**Tip:** If device address is 7-bit, the value of address is in range of 0x00 to 0x7F. If device's address is 10-bit, the value of address is in range of 0x00 to 0x3FF.)
  - If you select the **Data Length** condition:
    - a. Press **Address** soft key to set the SDA address length 7-bit or 10-bit.
    - b. Press **Byte Length** softkey and set the byte length by rotating the Universal Knob. The range of the Byte Length is 1 to 12.

## IIC Serial Decode

After completing the setup of IIC signal and trigger, we will decode IIC signals.

Operation steps as follows.

1. Press **Decode** → **Decode**. Select one of the options from the **Decode1** and **Decode2**.



Figure 38: IIC Decode Menu

2. Press **Display** and select **On** to display the result of decoding.
3. Press **List** to enter the **LIST** function menu.
4. Press **Display** and choose the same options as the first step.
5. Press **Lines** and set the number of lines by Universal Knob. The range of the lines is 1 to 7.
6. Press **Format** to change the character encoding format of the decoding result.
7. Press **Scroll** and turn the Universal Knob to view all frames.

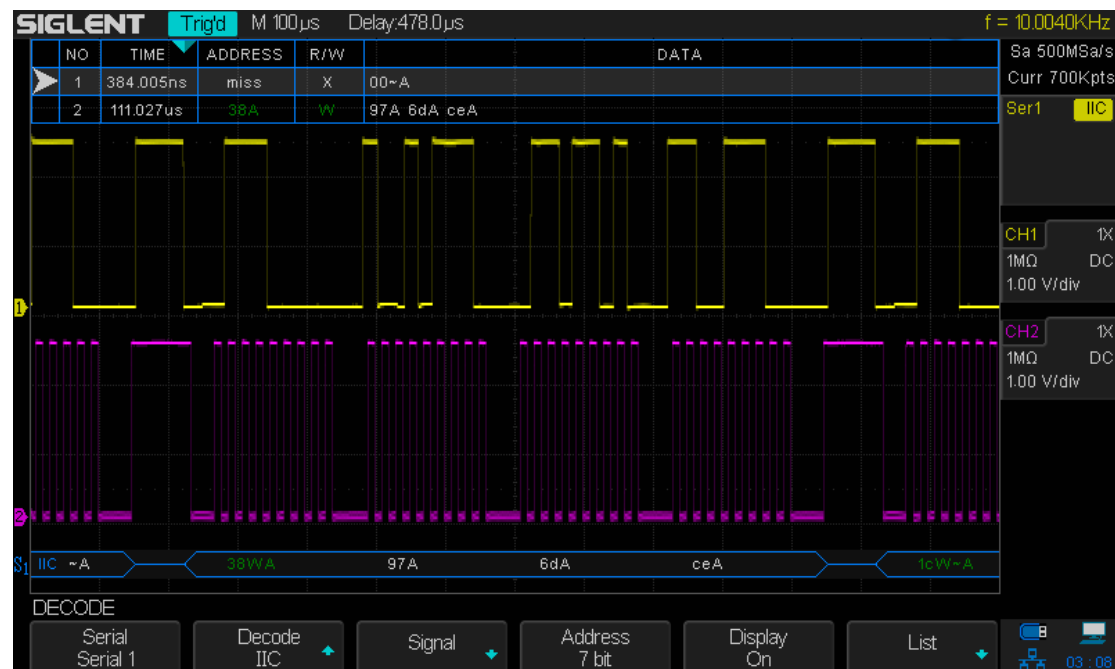

Figure 39: IIC Decode Result

## Interpreting IIC Decode

The frames of decoding result:

- The address of write frames are dark-green strings that contains “W”.
- The address of read frames are yellow strings that contains “R”.
- The data of frames are white strings.

**The lists of decoding result:**

- NO — The number of frames in screen.
- TIME (timestamp) — The horizontal displacement between current frame and trigger position.
- ADDRESS— The address of a frame.
- R/W— The type of a frame (write or read).
- DATA — The value of data.

## SPI Triggering and Serial Decode

The following section describes trigger and decoding for SPI and is organized as follows: “**Setup for SPI Signals**”, “**SPI Triggering**” and “**SPI Decode**”.

### Setup for SPI Signals

Setting the SPI (Serial Peripheral Interface) signal includes two steps: Connecting the CLK, MISO, MOSI and CS signals to oscilloscope; specifying the parameters of each input signal.

1. Press the **Decode** key to enter the **DECODE** function menu.
2. Press the **Decode** softkey and select the desired slot (Decode1 or Decode2).
3. Press **Protocol** softkey and then select **SPI** by turning Universal Knob.
4. Press **Signal** softkey to enter the **SIGNAL** menu as Figure 40 shows.

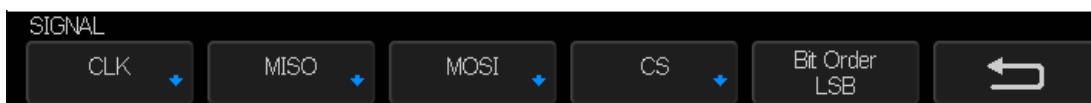

Figure 40: SINGAL Menu

5. Set CLK (clock signal):
  - a. Press the **CLK** softkey to enter **CLK** menu.
  - b. Press the **CLK** softkey to select the channel that is connected to the SPI clock signal.
  - c. Press the **Threshold** softkey to set the SPI clock signal threshold voltage level by Universal Knob. The threshold voltage level is for decoding, and it will be regarded as the trigger voltage level when set the trigger type to serial.
  - d. Press the **Edge Select** softkey to set whether the oscilloscope will sample at the clock signal rising edge or falling edge.
  - e. Press  softkey to return previous menu.



Figure 41: CLK Menu

6. Set MISO:
  - a. Press the **MISO** softkey to enter the MISO menu.
  - b. Press the **MISO** softkey to select the channel that is connected to the SPI MISO signal.
  - c. Press the **Threshold** softkey to set the SPI MISO signal threshold voltage level by Universal Knob. The threshold voltage level is for decoding, and it will be regarded as the trigger voltage level when the trigger type is set to serial.
  - d. Press  softkey to return previous menu.



Figure 42: MISO Menu

7. Set MOSI:
  - a. Press the **MOSI** softkey to enter the MOSI menu.
  - b. Press the **MOSI** softkey to select the channel that is connected to the SPI MOSI signal.
  - c. Press the **Threshold** softkey to set the SPI MOSI signal threshold voltage level by Universal Knob. The threshold voltage level is for decoding, and it will be regarded as the trigger voltage level when set the trigger type to serial.
  - d. Press  softkey to return previous menu.



Figure 43: MOSI Menu

8. Set CS:
  - a. Press the **CS** softkey to enter the MOSI menu.
  - b. Press the **CS Type** softkey to select the chip select type.
  - c. Modify the CS type's value.
  - d. Press  softkey to return previous menu.

Table 1 Menu Explanations of the Cs Type Parameters

Function Menu	Settings	Explanation
CS Type	~CS	Low voltage level of CS signal is available

---

	CS	High voltage level of CS signal is available
	CLK Timeout	If the time between two edges of clock signal is less than (or equal to) the value of timeout, the signal between the two edges is treated as a frame. The range of clock timeout is 100ns-5ms.

9. Press the **Bit Order** softkey to select the bit order (**LSB** or **MSB**).

## SPI Triggering

This part will provide a brief introduction and description for the operation of the SPI trigger.

1. Press **Setup** key to enter the **TRIGGER** function menu.
2. Press **Type** and select **Serial**.
3. Press **Protocol** and select **SPI**.
4. Press **Trigger Setting** softkey.



Figure 44: SPI TRIG SET Menu

5. Press the **Trigger Type** softkey to select the trigger condition.

Table 2 Menu Explanations of the SPI trigger type

Function Menu	Settings	Explanation
Trigger Type	MISO	Master-In, Slave-Out
	MOSI	Master-Out, Slave-In

6. Press the **Data Length** softkey, and turn the Universal Knob to set the length of a data.  
The range of data length is 4 to 96 bits.
7. Set the value of the trigger data.
  - Set the value of a bit:
    - a. Press the **Bit Roll** softkey to select a bit in data.
    - b. Press the **Bit Value** softkey to set the value of the selected bit.
  - Set the value of all bits:
    - a. Press the **All Same** softkey to set the value of all bits.

Table 3 Menu Explanations of the SPI Bit value

Function Menu	Settings	Explanation
Bit Value	0	High voltage level
	1	Low voltage level
	X	Don't care the voltage level



8. Press the **Next Page** softkey.
9. Press the **Bit Order** softkey to set the bit order(MSB or LSB).

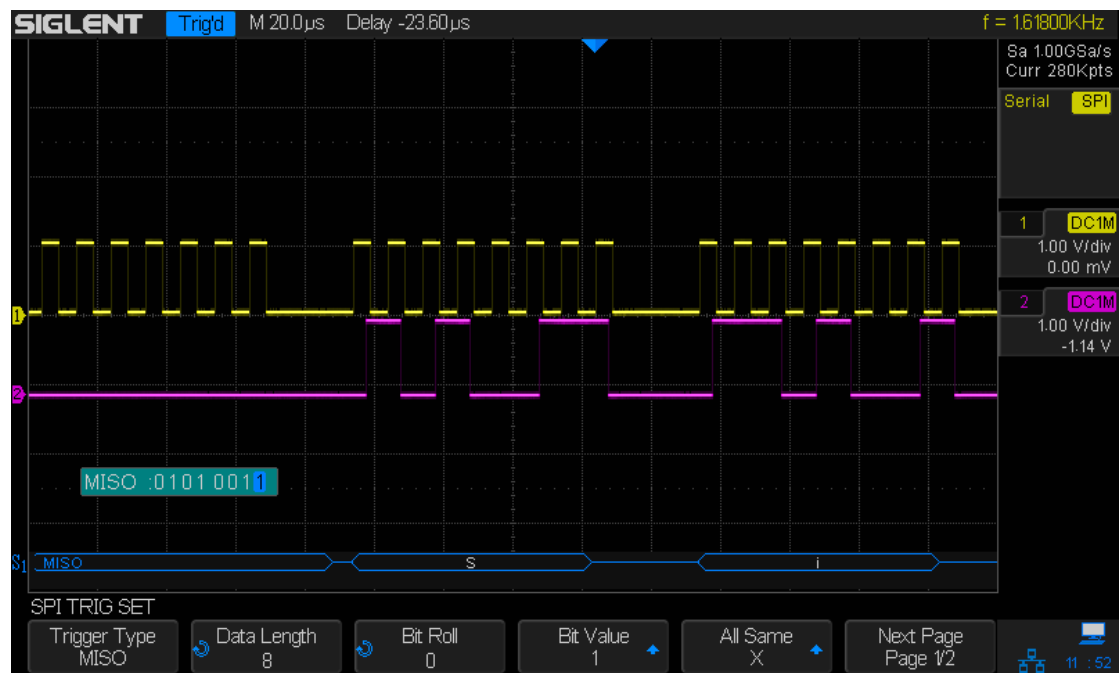

Figure 45: SPI Trigger

## SPI Serial Decode

The following describes decode SPI signals. Operation steps as follows.

1. Press **Decode** → **Decode**. Select one of the options from the **Decode1** and **Decode2**.
2. Press **Display** and select **On** to display the result of decoding.
3. Press **List** to enter the **LIST** function menu.
4. Press **Display** and choose the same options as the first step.
5. Press **Lines** and set the number of lines by the Universal Knob. The range of the lines is 1 to 7.
6. Press **Format** to change the character encoding format of the decoding result.
7. Press **Scroll** and turn the Universal Knob to view all frames.

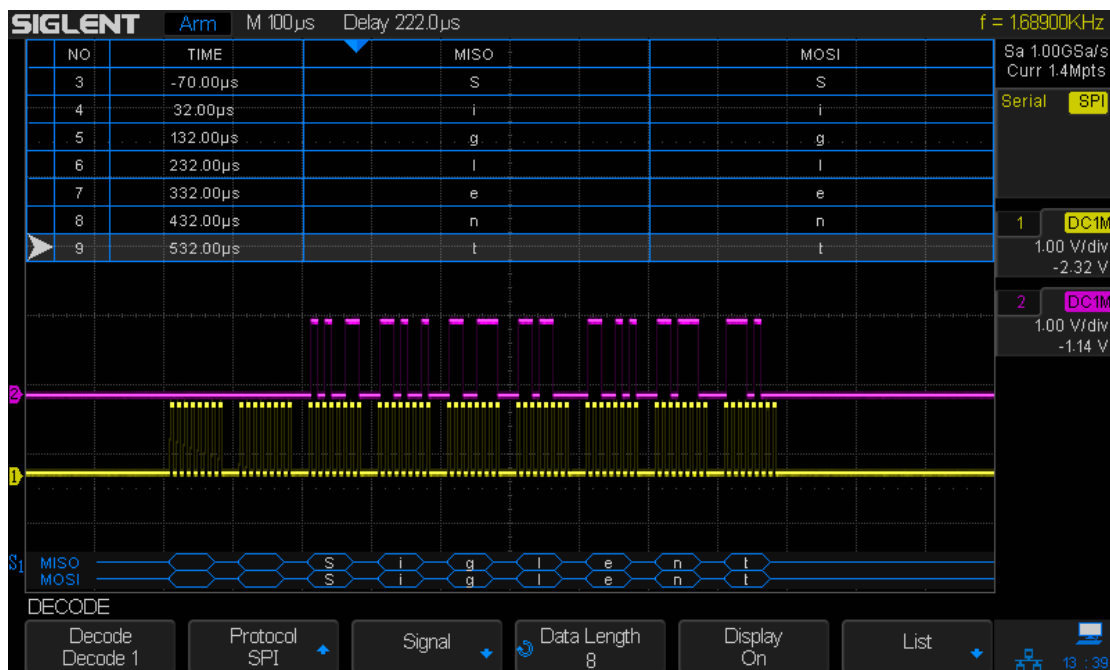

Figure 46: SPI Decode

## Interpreting SPI Decode

The frames of decoding result:

- MISO — the decoding result of “Master-In, Slave-Out” line.
- MOSI —the decoding result of “Master-Out, Slave-In” line.

**The lists of decoding result:**

- NO — the number of frames in screen.
- TIME (timestamp) — the horizontal displacement between current frame and trigger position.
- MISO — the decoding result of “Master-In, Slave-Out” line.
- MOSI —the decoding result of “Master-Out, Slave-In” line.

## UART/RS232 Trigger and Serial Decode

The following section describes trigger and decoding for UART/RS232 bus types and is organized as follows: “**Setup for UART/RS232 Signals**”, “**UART/RS232 Triggering**” and “**UART/RS232 Decode**”.

### Setup for UART/RS232 Signals

1. Press the **Decode** key to enter the **DECODE** function menu.
2. Press the **Decode** softkey and select the desired slot(Decode1 or Decode2).
3. Press **Protocol** softkey and then select **UART** by turning Universal Knob.
4. Press **Signal** softkey to enter the **SIGNAL** menu as Figure 47 shows.



Figure 47: UART SIGNAL Menu

5. Set RX:
  - 1) Press **RX** to select the channel that is connected to the RX signal.
  - 2) Press first **Threshold** key to set the RX signal threshold voltage level by Universal Knob. The threshold voltage level is for decoding, and it will be regarded as the trigger voltage level when the trigger type is set to serial.
6. Set TX:
  - a. Press **TX** to select the channel that is connected to the TX signal.
  - b. Press first **Threshold** key to set the TX signal threshold voltage level by Universal Knob. The threshold voltage level is for decoding, and it will be regarded as the trigger voltage level when the trigger type is set to serial.
7. Press the **Bit Order** softkey to select the bit order(**LSB** or **MSB**).
8. Press **Return** softkey to return previous menu.
9. Press the **Configure** softkey to enter **BUS CONFIG** menu.



Figure 48: BUS CONFIG Menu

10. Press **Baud** softkey to set the baud rate.
  - The baud rate can be set as predefined value.
  - If the desired baud rate is not listed, press **Baud** and select **custom** option, press the **Custom** and turn the Universal Knob to set the desired baud rate.
11. Press **Parity Check** softkey to set the type of parity check (Even, Odd or None).
12. Press **Stop Bit** softkey to set the length of stop bit (1, 1.5 or 2 bits).
13. Press **Idle Level** softkey to set the idle level (LOW or HIGH).
14. Press **Next Page** softkey.
15. Press **Data Length** softkey and set byte bits (5-8) by the Universal Knob.

## UART/RS232 Triggering

This part will provide a brief introduction and description for the operation of the UART trigger.

1. Press **Setup** key to enter the **TRIGGER** function menu.
2. Press **Type** and select **Serial**.
3. Press **Protocol** and select **UART**.
4. Press **Trigger Setting** softkey to enter **UART TRIG SET** menu.



Figure 49: UART TRIG SET Menu

5. Press the **Source Type** softkey to select the source of trigger (RX or TX).
6. Press the **Condition** softkey and set up the desired trigger condition:
  - **Start** — The oscilloscope will be triggered at the position of start bit.
  - **Stop** — The oscilloscope will be triggered at the position of stop bit.
  - **Data** — The oscilloscope will be triggered when found a byte which is equal to (greater or less than) the specified data.
    - a. Press the **Compare Type** softkey and choose an equality qualifier (>, < or =).
    - b. Press the **Value** softkey to set data's value. Data's value is in range of 0x00 to 0xff.
  - **ERROR** — If the parity check has been set and the bit of parity check is an error, the oscilloscope will be triggered.

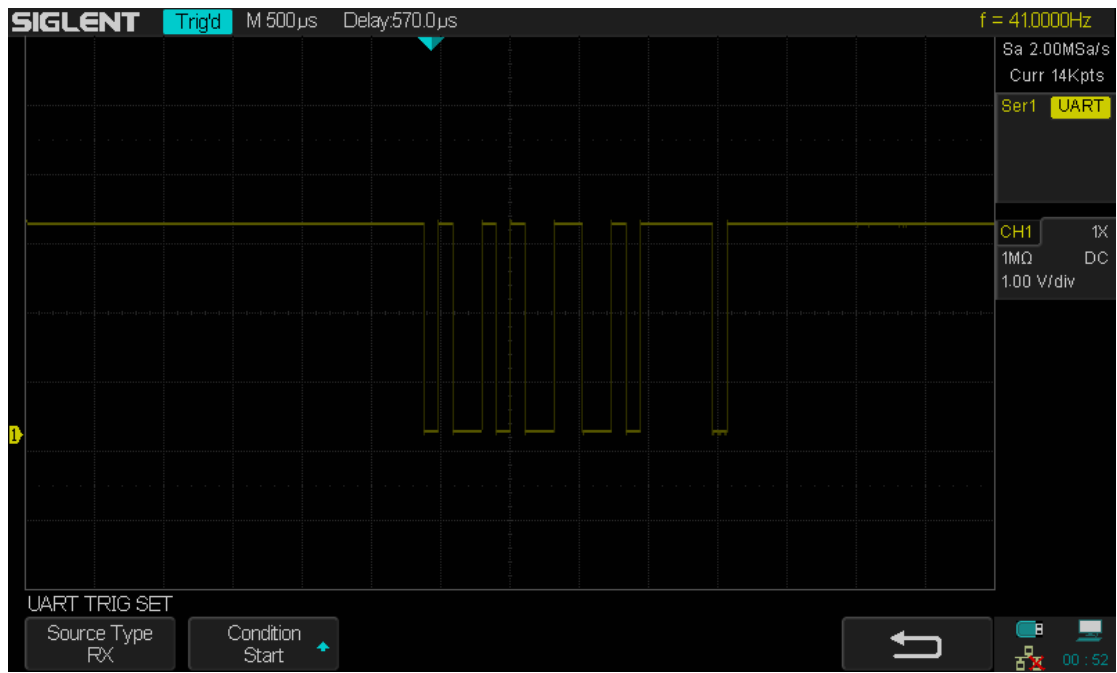

Figure 50: UART Trigger

## UART/RS232 Serial Decode

After completing the setup of UART signal and trigger, we will decode UART signals.

Operation steps as follows.

1. Press **Decode** → **Decode**. Select one of the options from the **Decode1** and **Decode2**.
2. Press **Display** and select **On** to display the result of decoding.
3. Press **List** to enter the **LIST** function menu.
4. Press **Display** and choose the same options as the first step.
5. Press **Lines** and set the number of lines by Universal Knob. The range of the lines is 1 to 7.
6. Press **Format** to change the character encoding format of the decoding result.
7. Press **Scroll** and turn the Universal Knob to view all frames.

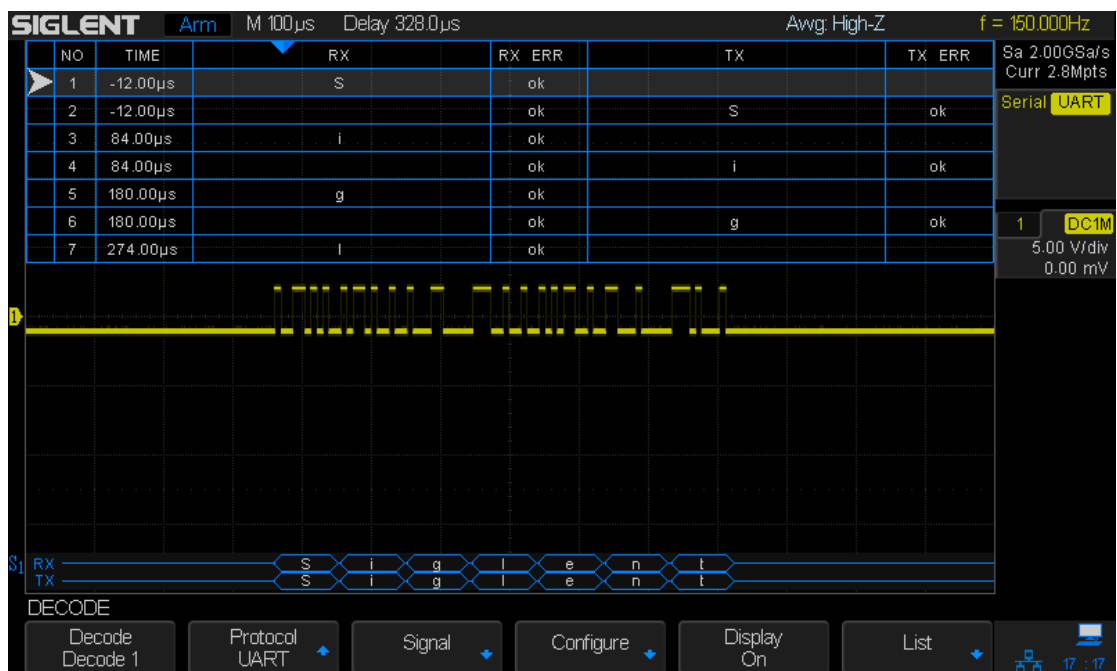

Figure 51: CAN Decode



---

## Interpreting UART/RS232 Decode

### The frames of decoding result:

- RX— The decoding result of the data received.
- TX— The decoding result of the data transmitted.

### The lists of decoding result:

- NO — The number of frames in screen.
- TIME(timestamp) — The horizontal displacement between current frame and trigger position.
- RX — The receiving channel.
- TX — The transmitting channel.
- RX ERR— Parity error or unknown error in the data received.
- TX ERR— Parity error or unknown error in the data transmitted.

## CAN Trigger and Serial Decode

The following section describes trigger and decoding for the CAN bus and is organized as follows: “**Setup for CAN Signals**”, “**CAN Triggering**” and “**CAN Serial Decode**”.

### Setup for CAN Signals

1. Press the **Decode** key to enter the **DECODE** function menu.
2. Press the **Decode** softkey and select the desired slot (Decode1 or Decode2).
3. Press **Protocol** softkey and then select **CAN** by turning Universal Knob.
4. Press **Signal** softkey to enter the **SIGNAL** menu as Figure 52 shows.



Figure 52: CAN SIGNAL Menu

5. Set CAN-H:
  - a. Press **CAN-H** softkey to select the channel that is connected to the CAN-H signal.
  - b. Press first **Threshold** key to set the CAN-H signal threshold voltage level by the **Universal Knob**. The threshold voltage level is for decoding, and it will be regarded as the trigger voltage level when set the trigger type to serial.
6. Set CAN-L:
  - a. Press **CAN-L** to select the channel that is connected to the CAN-L signal.
  - b. Press second **Threshold** key to set the CAN-L signal threshold voltage level by the **Universal Knob**. The threshold voltage level is for decoding, and it will be regarded as the trigger voltage level when set the trigger type to serial.
7. Press the **Configure** softkey to enter the **BUS CONFIG** menu.
8. Press **Baud** to set baud rate by the Universal Knob.
  - The baud rate can be set as a predefined value (from 5kb/s to 1Mb/s) or custom value (from 1b/s to 1Mb/s).

- If the desired baud rate is not listed, press **Baud** and select **custom** option, press the **Custom** and turn the Universal Knob to set the desired baud rate.
9. Press **Decode Source** to select the signal to be decoded.
- **CAN\_H** — CAN\_H signal will be decoded.
  - **CAN\_L** — CAN\_L signal will be decoded.
  - **CAN\_H-CAN\_L** — CAN\_H and CAN\_L are both used as the source of decoding.

## CAN Triggering

This part will provide a brief introduction and description for the operation of the CAN trigger.

### To introduce the trigger conditions

- **Start**— The oscilloscope will be triggered at the start bit of a frame.
- **Remote** — The oscilloscope will be triggered by a remote frame with specified ID.
- **ID** — The oscilloscope will be triggered by a remote or data frame that have specified ID.
- **ID+DATA**— The oscilloscope will be triggered by data frame that have specified ID and data.
- **Error**— The oscilloscope will be triggered by an error frame.

### Operation steps:

1. Press **Setup** to enter the **TRIGGER** function menu.
  2. Press **Type** and select **Serial**.
  3. Press **Protocol** and select **CAN**.
  4. Press **Trigger Setting** to enter the **CAN TRIG SET** menu.
  5. Press **Condition** and select the trigger condition by the Universal Knob:
    - If you select the **REMOTE** and **ID** condition:
      - a. Press **ID Bits** to set the length of ID (11bits or 29 bits).
      - b. Press **Curr ID Byte** and use the Universal Knob to select the byte that you want to set.
      - c. Press the **ID** and set the ID's value by the Universal Knob.
- (**Tip:** In order to make it convenient for the operator to set the parameters, the ID is split into several bytes. For example, if the ID length is 11 bits, it will be split into two bytes, a byte includes 8 bits. If “1st byte” is selected, only the 8 least

significant bits can be changed.)

- If you select the **ID+DATA** condition:
  - a. Press **ID bits** softkey to select the ID's length (11 or 29 bits).
  - b. Press **Curr ID Byte** softkey and use the Universal Knob to select the byte that you want to modify.
  - c. Press the **ID** softkey and set the ID's value by the Universal Knob.
  - d. Press **Data1** softkey and set the value of the first byte by the Universal Knob.
  - e. Press **Data2** softkey and set the value of the second byte by the Universal Knob.

See as Figure 53, the trigger condition is ID, ID's value is 0x013, Baud rate is 100kb/s:

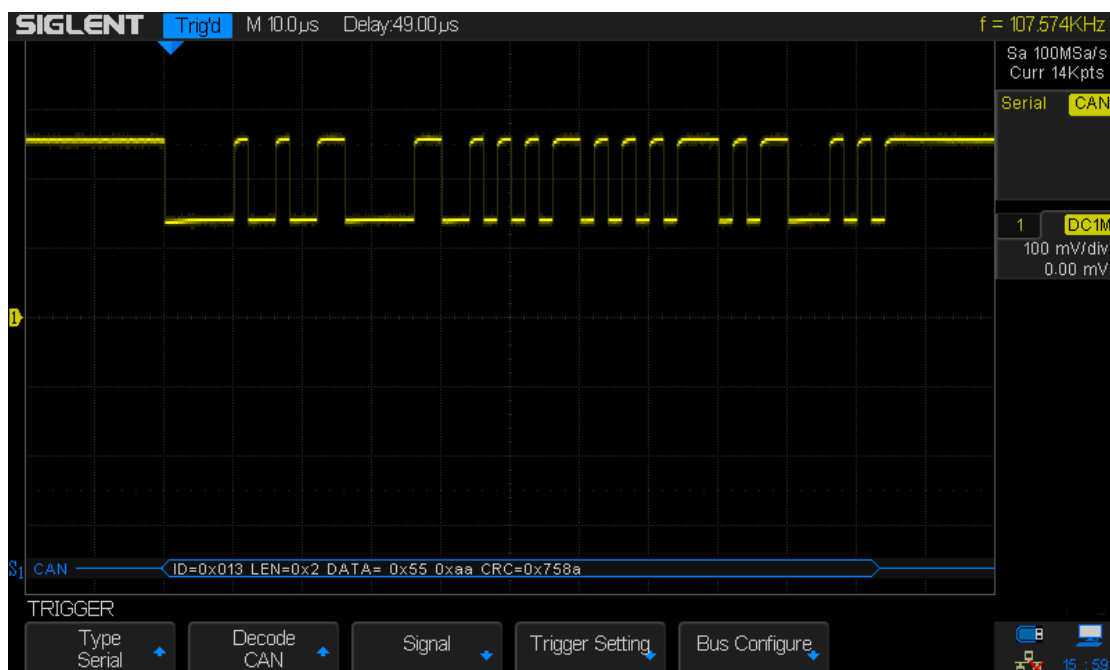

Figure 53: CAN Trigger

## CAN Serial Decode

After completing the setup of can signal and trigger, we will decode CAN signals. Operation steps as follows.

1. Press **Decode** → **Decode**. Select one of the options from the **Decode1** and **Decode2**.
2. Press **Display** and select **On** to display the result of decoding.
3. Press **List** to enter the **LIST** function menu.
4. Press **Display** and choose the same options as the first step.
5. Press **Lines** and set the number of lines by the Universal Knob. The range of the lines is 1 to 7.
6. Press **Format** to change the character encoding format of the decoding result.
7. Press **Scroll** and turn the Universal Knob to view all frames.

The interface of decoding is shown below. The can signal id is 0x013.

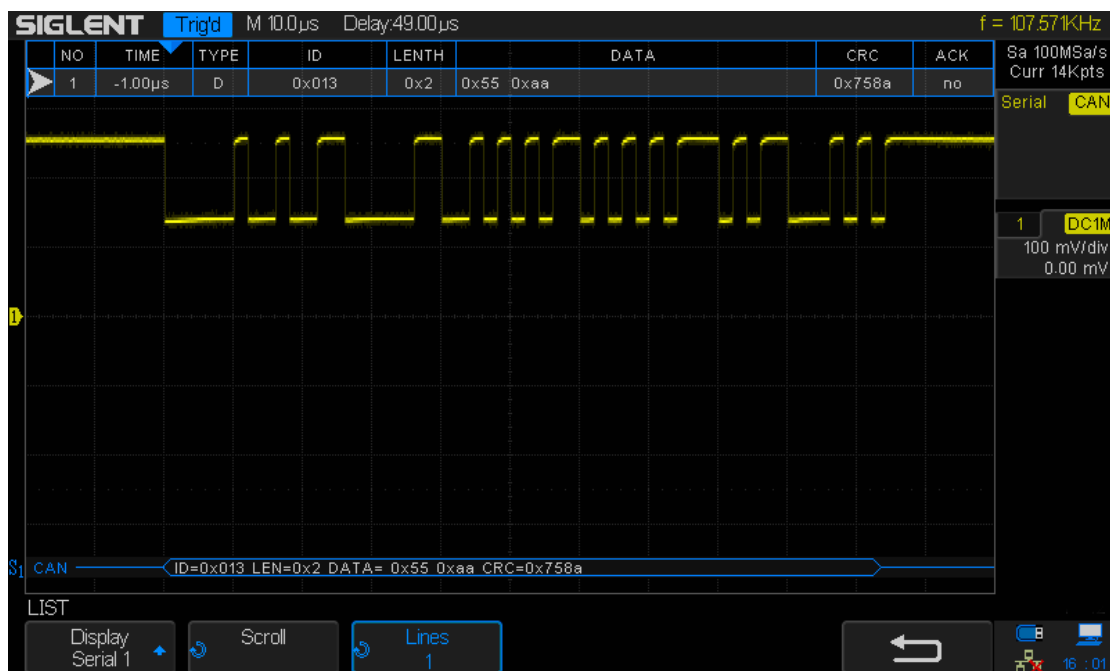

Figure 54: CAN Decode

---

## Interpreting CAN Decode.

### The frame of decoding result:

- Arbitration field is displayed in frame
- Control field is displayed in frame
- Data field is displayed in frame
- CRC field is displayed in frame

### The list of decoding result:

- NO — The number of frames in screen.
- TIME (timestamp) — The horizontal displacement between current frame and trigger position.
- TYPE — The type of frames, “D” represents data frame, “R” represents remote frame.
- ID — The id of frames. The oscilloscope can automatically detect the length of a frames id (11 bits or 27 bits).
- LENGTH — The length of the data field.
- DATA — The value of the data field.
- CRC — The value of the CRC (Cyclic Redundancy Check) field.
- ACK — Acknowledgment bit.

## LIN Triggering and Serial Decode

The following section describes trigger and decoding for the LIN bus and is organized as follows: “**Setup for LIN Signals**”, “**LIN Triggering**” and “**LIN Decode**”.

### Setup for LIN Signals

There are two steps of setting the LIN signal: Connecting the signal to oscilloscope and specifying the parameters of each input signal.

1. Press the **Decode** key to enter the DECODE function menu.
2. Press the **Decode** softkey and select the desired slot (Serial 1 or Serial 2).
3. Press **Protocol** softkey and then select **LIN** by turning the Universal Knob.
4. Press **Signal** softkey to enter the **SIGNAL** menu as Figure 55 shows.



Figure 55: LIN SIGNAL Menu

5. Press **Source** softkey to select the channel that is connected to the LIN signal.
6. Press the **Threshold** softkey and set the LIN signal threshold voltage level by the Universal Knob. The threshold voltage level is for decoding, and it will be regarded as the trigger level when the trigger type is set to serial.
7. Press **←** softkey to return previous menu.
8. Press the **Configure** softkey to enter the **BUS CONFIG** menu.
9. Press **Baud** softkey to set the baud rate.
  - The baud rate can be set as a predefined value.
  - If the desired baud rate is not listed, select **custom** option, press the **Custom** and turn the Universal Knob to set the desired baud rate.



## LIN Triggering

This part will provide a brief introduction and description for the operation of the LIN trigger.

### To introduce the trigger conditions

- **Break**— The oscilloscope will be triggered at the position of the break field's break delimiter.
- **ID (Frame ID)** — The oscilloscope will be triggered at the position of identifier field's stop bit, if the value of a frames ID is equal to the specified value.  
(Note: If the data's value is 0xXX, any data value will be matched)
- **ID + Data (Frame ID and Data)** — The oscilloscope triggers when a frame with an ID and data equal to the selected value is detected. Use the Universal Knob to select the value for the ID, Data1 and Data2.
  - 1) The ID's value is the same as the set value.
  - 2) If you have set either Data1's or Data2's value, and the signal has a data is the same as that value. If you have set both Data1's and Data2's value, the signal should have two consecutive data packets. The first packet value is Data1, the second Data2.  
(**Note:** If the data's value is 0xXX, any data value will be matched)
- **Data Error**— The oscilloscope will be triggered when errors (such as ID check error, checksum error, sync byte field error) are detected.

### Operation steps:

1. Press **Setup** to enter the **TRIGGER** function menu.
2. Press **Type** and select **Serial**.
3. Press **Protocol** and select **IIC**.
4. Press **Trigger Setting** softkey to enter **LIN TRIG SET** menu.

5. Press **Condition** and select the trigger condition by the Universal Knob:

- If you **select ID** condition:
  - a. Press **ID** softkey and set its value by turning the Universal Knob.
- If you **select ID+DATA** condition:
  - a. Press **ID** softkey and set its value by turning the Universal Knob.
  - b. Press **DATA1** softkey and set its value by turning the Universal Knob.
  - c. Press **DATA2** softkey and set its value by turning the Universal Knob.

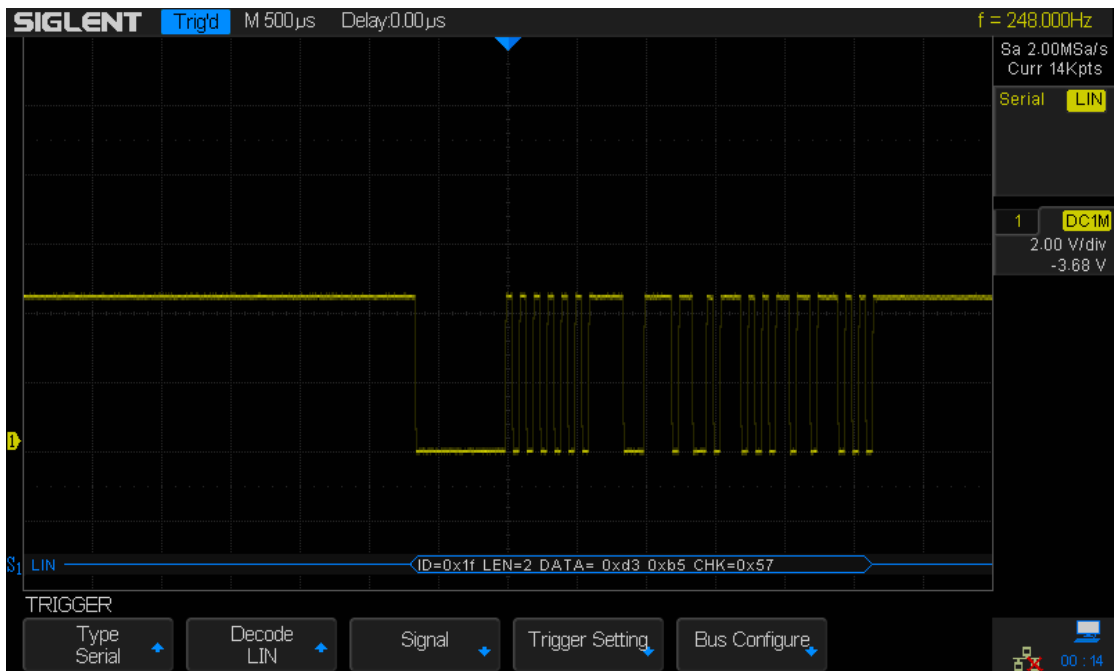

Figure 56: LIN Trigger

## LIN Serial Decode

After completing the setup of SPI signal and trigger, we will decode SPI signals. Operation steps as follows.

1. Press **Decode** → **Decode**. Select one of the options from the **Decode1** and **Decode2**.
2. Press **Display** and select **On** to display the result of decoding.
3. Press **List** to enter the **LIST** function menu.
4. Press **Display** and choose the same options as the first step.
5. Press **Lines** and set the number of lines by the Universal Knob. The range of the lines is 1 to 7.
6. Press **Format** to change the character encoding format of the decoding result.
7. Press **Scroll** and turn the Universal Knob to view all frames.

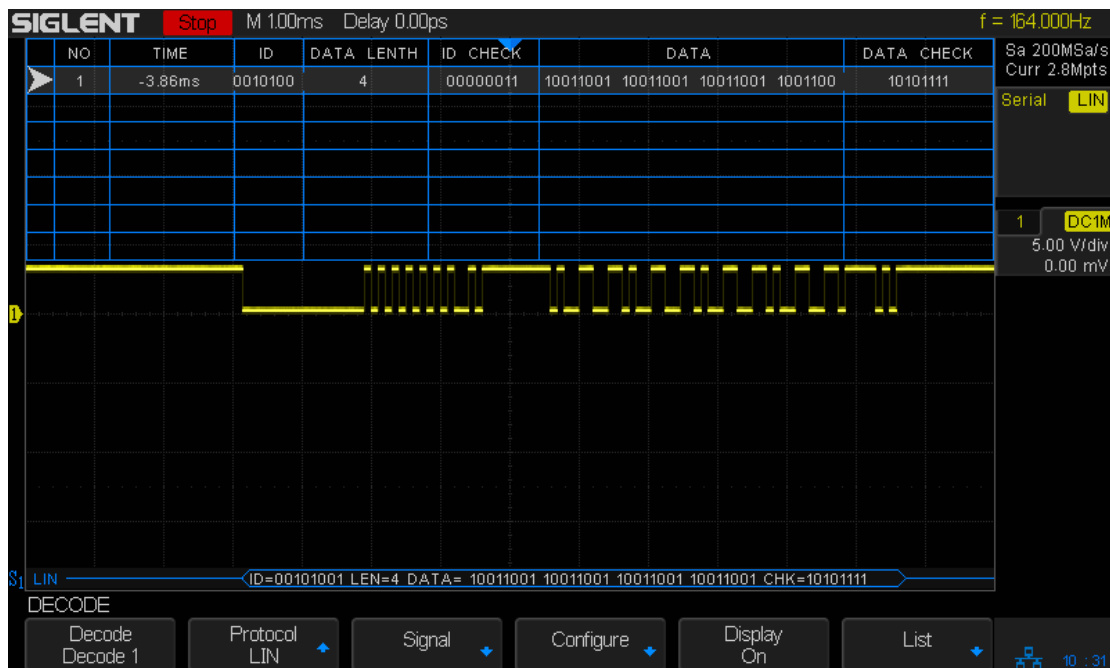

Figure 57: LIN Decode

## Interpreting LIN Decode

The frame of decoding result:

- Protected Identifier Field is displayed in the frame

- Data Length is displayed in the frame
- Data Field is displayed in the frame.
- Checksum Field is displayed in the frame.

**The list of decoding result:**

- NO — The number of frames in screen.
- TIME (timestamp) — The horizontal displacement between the current frame and trigger position.
- ID — The value of frame's Protected Identifier Field.
- DATA LENGTH — The length of the Data Field.
- ID CHECK — The two check bits of the Protected Identifier Field.
- DATA — The value of the Data Field.
- DATA CHECK — The value of the Checksum Field.

---

# Digital Channels

This chapter describes how to use the digital channels of a Mixed-Single Oscilloscope (MSO).

The digital channels are enabled on SDS2000X series oscilloscopes that have installed the MSO activation license.

This chapter contains the following items:

- ◆ [To Connect the Digital Probes to the Device-under-test](#)
- ◆ [Acquiring Waveform Using the Digital Channels](#)
- ◆ [To Change the Display Type of the Digital Channels](#)
- ◆ [To Switch a Single Channel On or Off](#)
- ◆ [To Switch All Digital Channels On or Off](#)
- ◆ [To Change the Logic Threshold for Digital Channels](#)
- ◆ [To Reposition a Digital Channel](#)
- ◆ [To Display Digital Channels as a Bus](#)

## To Connect the Digital Probes to the Device-under-test

1. If necessary, turn off the power supply to the device-under-test.
  - Turning off the power to the device-under-test prevents damage that might occur if you accidentally short lines together while connecting probes. You can leave the oscilloscope powered on because no voltage appears at the probes.
2. Connect one of the digital probe cable ports to the digital channels connector on the front panel of the SDS2000X, and the other one to the digital channels connector of the digital probe.
  - The digital probe cable is keyed so you can connect it only one way. You do not need to power-off the oscilloscope.
3. Connect a fly line to one of the digital probe ground pins, connect a grabber to the fly line, and then connect the grabber to a ground trace/pin from the device-under-test. The ground lead improves signal fidelity to the oscilloscope, ensuring accurate measurements,
4. Connect a fly line to one of the digital probe digital channel pins; connect a grabber to the fly line, and then connect the grabber to a node in the circuit you want to test.
5. Repeat step 4 until you have connected all points of interest.

## Acquiring Waveform Using the Digital Channels

Press the **Digital** button on the front panel to open the digital channels and start acquiring digital channel waveforms.

For digital channels, each time the oscilloscope takes a sample it compares the input voltage to the logic threshold. If the voltage is above the threshold, the oscilloscope stores a 1 in the sample memory; otherwise, it stores a 0.

## To Change the Display Type of the Digital Channels

1. Press the **Digital** button on the front panel to open the DIGITAL function menu.



Figure 58: Digital Function Menu

2. Press the **Channel High** softkey to select **Low, Middle, High** display type.

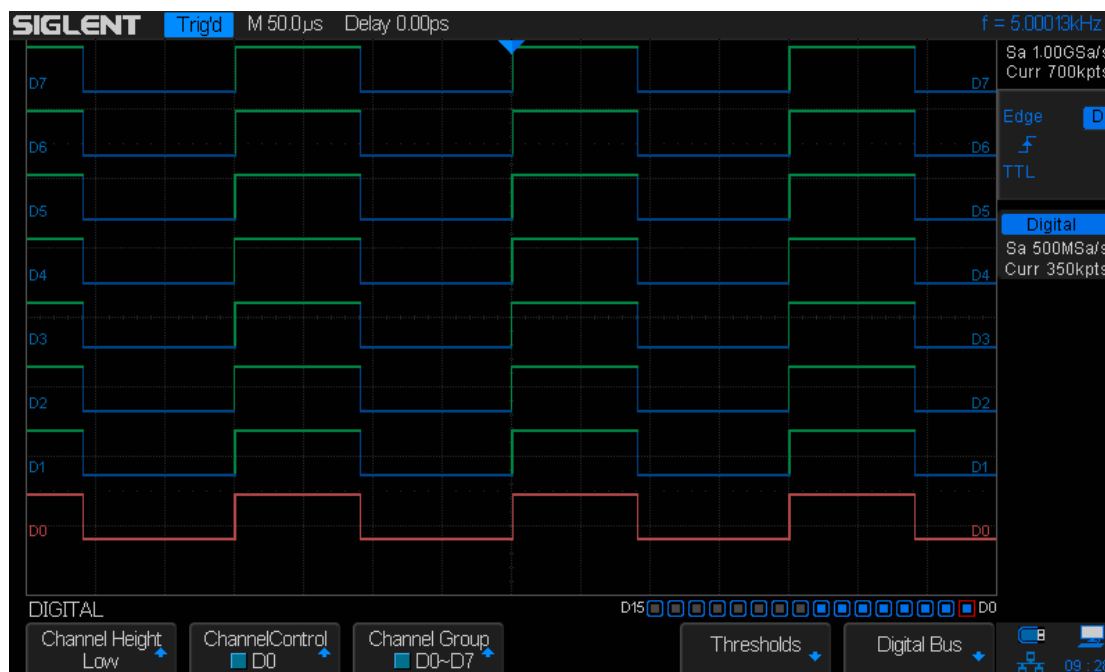

Figure 59: Low Display Type

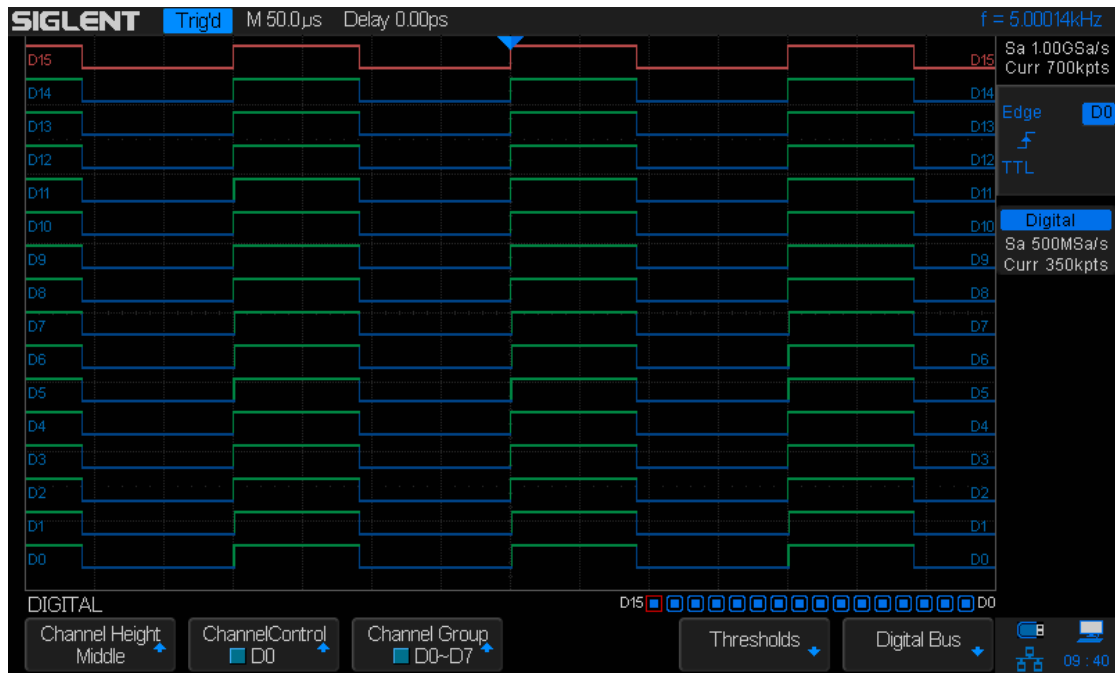

Figure 60: Middle Display Type

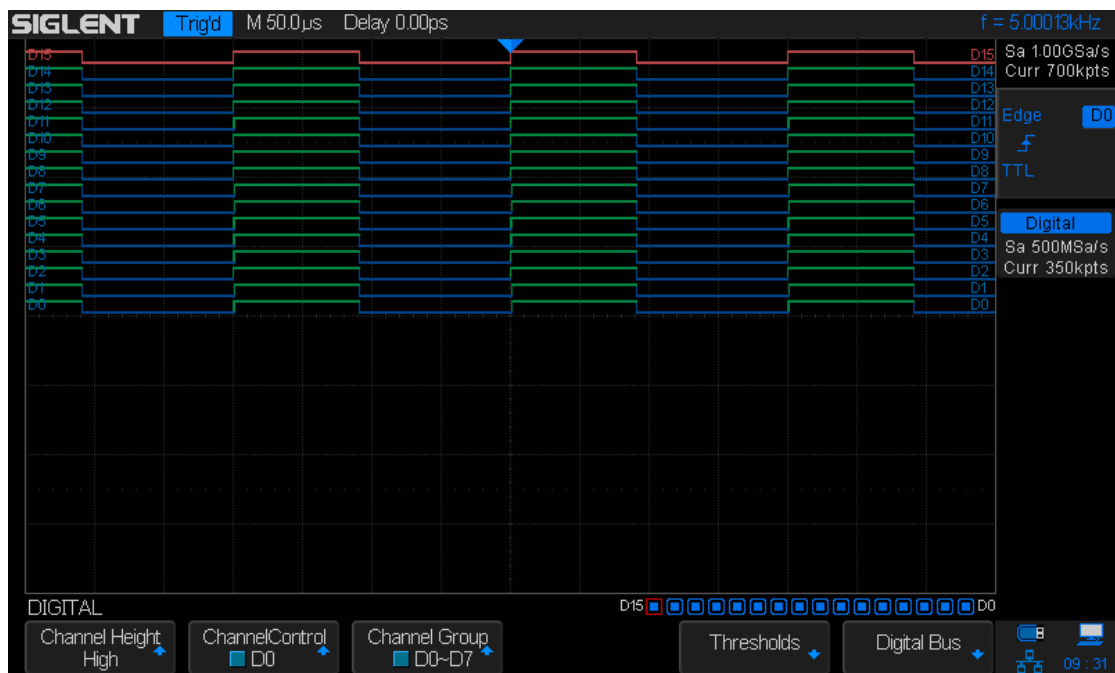

Figure 61: High Display Type

The display type control lets you spread out or compress the digital traces vertically on the display for more convenient viewing.



## To Switch a Single Channel On or Off

1. Press the **Digital** button on the front panel to open the DIGITAL function menu.
2. Press the **Channel Control** softkey, then turn the Universal Knob to select the desired channel such as **Dx** and push down the knob to confirm.
3. Press the **Dx** softkey to select **On** or **Off** to switch the selected channel on or off.

## To Switch All Digital Channels On or Off

1. Press the **Digital** button on the front panel to open the DIGITAL function menu.
2. Press the **Channel Group** softkey to select **On** or **Off** to switch all digital channels which in this group on or off.
  - Also, under the DIGITAL function menu, press the **Digital** button on the front panel to switch all digital channels off.

## To Change the Logic Threshold for Digital Channels

1. Press the **Digital** button on the front panel to open the DIGITAL function menu.
2. Press the **Threshold** softkey to enter the THRESHOLDS menu.
3. Press the **D0~D7** or **D8~D15** softkey, then turn the **Universal Knob** to select a logic family preset or select Custom to define your own threshold.



Figure 62: THRESHOLDS Function Menu

Logic Family	Threshold Voltage
TTL	1.5V
CMOS	1.65V
LVC MOS3.3	1.65V
LVC MOS2.5	1.25V
Custom	Variable from -3V to +3V

- The threshold you set applies to all channels.
- Values greater than the set threshold are high (1) and values less than the set threshold are low (0).
- If the **D0~D7** or **D8~D15** softkey is set to **Custom**, press the **Custom** softkey, then turn the **Universal Knob** to select the desired value and push down the knob to confirm.

## To Reposition a Digital Channel

1. Press the **Digital** button on the front panel to open the DIGITAL function menu and display the digital channel waveforms.
2. Turn the **Ref/Math Waveform Vertical Position Knob** to select the channel that you wish to reposition. The selected waveform is highlighted in red.
3. Turn the **Ref/Math Waveform Vertical Variable Knob** to move the selected channel to current position.

## To Display Digital Channels as a Bus

Digital channels may be grouped and displayed as a bus, with each value displayed at the bottom of the display in hex or binary. You can create up two buses.

To configure and display each bus, do the following steps:

1. Press the **Digital** button on the front panel to open the DIGITAL function menu and display the digital channel waveforms.
2. Press the **Digital Bus** softkey to enter the DIGITALBUS function menu.

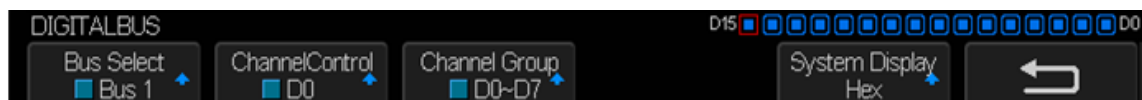

Figure 63: DIGITALBUS Function Menu

3. Press the **Bus Select** softkey to select **Bus1** or **Bus 2**.
4. Press the **Display** softkey to select **On** to display the bus at the bottom of the display.
  - Under the DIGITAL function menu, press the **Channel Control** softkey, turn the **Universal Knob** to select such as **DX**, and then press the **Dx** softkey to select **On** or **Off** to set the channel to be included or excluded in the bus.
  - Under the DIGITAL function menu, press the **Channel Group** softkey to select **On** or **Off** to include or exclude all digital channels in this group.
  - Under the DIGITAL function menu, an status indicator is displayed in the status

line at the bottom of the display. Light blue shows the digital channel is included in the bus while black shows it is excluded in the bus.

- Under the DIGITAL function menu, press the **System Display** softkey to select **Binary** or **Hex** to display the bus values.
- The Sampling rate of digital channels is displayed at the right of the display.

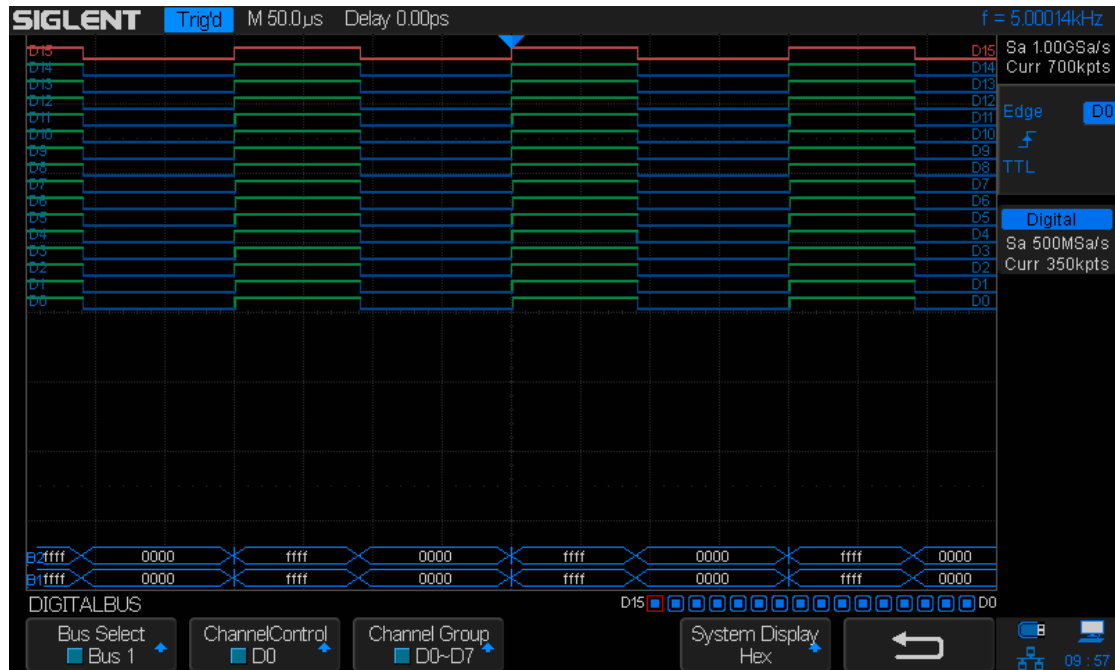

Figure 64: Digital Bus

## To Save Reference Waveform

SDS2000X can save analog channel or math waveforms to one of four reference waveform locations in the oscilloscope internal memory. Then, a reference waveform can be displayed and compared against other waveforms. Four reference waveforms can be displayed at a time.

Use the appointed Variable knob and the Position knob which on the right side of the front panel to adjust the vertical scale and the vertical position of REF waveform.

The contents of this chapter:

- [To Save REF Waveform to Internal Memory](#)
- [To Display REF Waveform](#)
- [To Adjust REF Waveform Display](#)
- [To Clear REF Waveform Display](#)

## To Save REF Waveform to Internal Memory

Do the following steps to save the REF waveform to internal memory:

1. Press the **REF** button on the front to enter the REF WAVE function menu. Note that when the time horizontal format is in X-Y mode, REF function cannot be enabled.
2. Press the **Source** softkey; then, turn the **Universal Knob** to select the source of reference channel. The source includes analog channel and math waveforms.
3. Press the **Location** softkey; then, turn the **Universal Knob** to select the position to save the REF waveform. The source includes analog channel and math waveforms.
4. Press the **Save** softkey to save the channel or math waveform to the appointed location. The vertical scale information and the vertical offset of the waveform will be saved at the same time. It will pop out the message "**Store Data Success**" when the waveform has been saved successfully.

Note: The REF waveforms are non-volatile. The REF waveform can still be saved after restarts or a reset to default operation settings.

## To Display REF Waveform

To the following steps to display REF waveform:

1. Press the **REF** button on the front to enter the REF WAVE function menu.
2. Press the **Location** softkey; then, turn the **Universal Knob** to select the REF waveform that you want to display.
3. Press the **Display** softkey to select **On** to display the REF waveform on the screen. Only saved location can be displayed. SDS2000X can display all four reference waveforms at a time.

## To Adjust REF Waveform Display

1. Please refer to the “To Display REF Waveform” above to display the desired reference waveform.
2. Use the Vertical Scale knob and Vertical Position knob for Math/Ref to adjust the vertical scale and position of the reference waveform. The vertical scale and position information displays at the middle of the screen.

The initial values displayed at the middle of the screen are the setups when the reference waveform was saved.

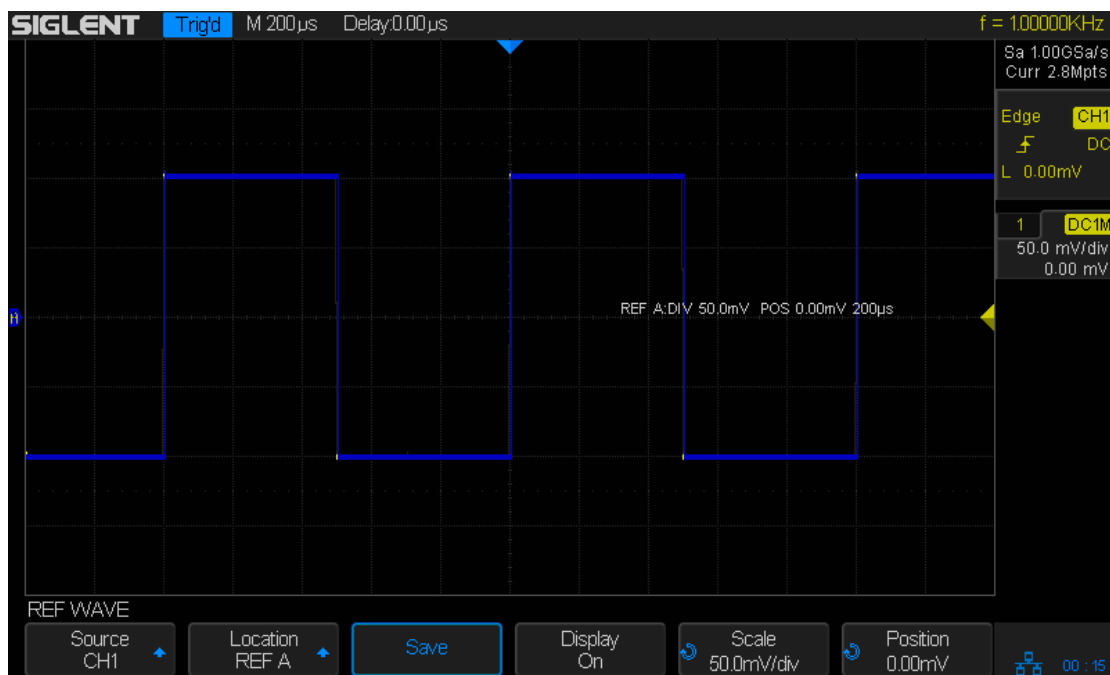

Figure 65: Reference Waveform

Note: The vertical Variable knob and the vertical Position knob only work for the reference waveform and the math waveform. Please note the difference with the channel vertical system.

## To Clear REF Waveform Display

SDS2000X does not have the “Clear” option under the REF WAVE function menu. To clear the appointed reference waveform, you can save a new reference waveform to the same location to replace it.

# To Use the Math Operation

SDS2000X supports many math operations between analog channels and reference waveforms, including addition (+), subtraction (-), multiplication (\*), division (/), differential (d/dt), integral ( $\int dt$ ), square root ( $\sqrt{\quad}$ ). The resulting math waveform is displayed in white and labeled with "M". You can use cursors to measure it.

The contents of this chapter:

- ◆ [Units for Math Waveforms](#)
- ◆ [Math Operators](#)
- ◆ [To Adjust the Math Waveform Scale and Offset](#)

Note: If the analog channel or the math function display is truncated (waveforms do not display on the screen completely), the resulting math will also be truncated.

## Units for Math Waveforms

Use the channel function menu to set the unit of each channel to “V” or “A”. SDS2000X math operation includes units as below:

Math Operation	Unit
Addition (+)or subtraction (-)	V, A
multiplication (*)	V <sup>2</sup> , A <sup>2</sup> or W (Volt-Amp)
division (/)	None or S
FFT	dBVrms, Vrms, dBArms, Arms, dBm
differential (d/dt)	V/S or A/S (V/second or A/second)
integral (∫dt)	VS or AS (V/second or A/second)
square root (√)	V <sup>1/2</sup> or A <sup>1/2</sup>



## Math Operators

SDS2000X supports standard math operations (addition, subtraction, multiplication, division), FFT (Fast Fourier Transform) operation, and complex math functions (differential, integral, square root).

### Addition or Subtraction

Math operators perform arithmetic operations - addition or subtraction- on any two analog input channels. When you select addition or subtraction, the **Source A** and **Source B** values are added or subtracted point by point, and the result is displayed.

1. Press the **Math** button on the front panel to enter the MATH function menu.
2. Press the **Source A** and **Source B** softkey respectively, and then turn the **Universal Knob** to select the source to do math operation. Analog channels (CH1~4) and reference waveforms (REF) can be used as Source A or source B.
3. Press the **Operation** softkey and then turn the universal to select **+** or **-** to make addition or subtraction operation. The resulting math waveform is displayed in white and labeled with "M".



Figure 66: Reference Waveform

4. If you want to invert the math waveform, press the **Invert** button and set the option to **On** to invert the display of the math waveform.

## Multiplication and Division

Math operators perform arithmetic operations multiplication or division operation on any two analog input channels. When you select multiplication or division, the **Source A** and **Source B** values are multiplied or divided point by point and the result is displayed.

1. Press the **Math** button on the front panel to enter the MATH function menu.
2. Press the **Source A** and **Source B** softkey respectively, and then turn the **Universal Knob** to select the source to do math operation. Analog channels (CH1 ~4) and reference waveforms (REFA, REFB, REFC, REFD) can be used as Source A or source B.
3. Press the **Operation** softkey and then turn the universal to select \* or / to make multiplication or division operation. The resulting math waveform is displayed in white and labeled with "M".



Figure 67: Reference Waveform

4. If you want to invert the math waveform, press the **Invert** button and set the option to **On** to invert the display of the math waveform.

## FFT Operation

FFT is used to compute the fast Fourier transform using analog input channels or reference waveforms. FFT takes the digitized time record of the specified source and transforms it to the frequency domain. When the FFT function is selected, the FFT spectrum is plotted on the oscilloscope display as magnitude in dBV versus frequency. The readout for the horizontal axis changes from time to frequency (Hertz) and the vertical readout changes from volts to dB.

FFT operation can facilitate the following works:

- ◆ Measure harmonic components and distortion in the device-under-test
- ◆ Measure the characteristics of the noise in DC power
- ◆ Analyze vibration

**To display a FFT waveform:**

1. Press the **Math** button on the front panel to open the MATH function menu.
2. Press the **Operation** softkey and then turn the **Universal Knob** to select **FFT**. The resulting math waveform is displayed in white and labeled with “M”.
3. Press the **Source** softkey, and then turn the **Universal Knob** to select the source to do FFT operation. Analog channels (CH1~4) and reference waveforms (REFA, REFB, REFC and REFD) can be used as the source.
4. Press the **Window** softkey, and then turn the **Universal Knob** to select an appropriate window.

Spectral leakage can be considerably decreased when a window function is used. SDS2000X provides five windows (Rectangle, Blackman, Hanning, Hamming, Flattop) which have different characteristics and are applicable to measure different waveforms. You need to select the window function according to different waveforms and their characteristics. Please read the table below carefully to make an appropriate option according to the input signal.

Window	Applications and Characteristics
<b>Rectangle</b>	These are normally used when the signal is transient (completely contained in the time-domain window) or known to have a fundamental frequency component that is an integer multiple of the fundamental frequency of the window. Signals other than these types will show varying amounts of spectral leakage and scallop loss, which can be corrected by selecting another type of window
<b>Hanning</b>	These reduce leakage and improve amplitude accuracy. However, frequency resolution is also reduced.
<b>Hamming</b>	These reduce leakage and improve amplitude accuracy. However, frequency resolution is also reduced.
<b>Flat Top</b>	This window provides excellent amplitude accuracy with moderate reduction of leakage, but with reduced frequency resolution.
<b>Blackman</b>	It reduces the leakage to a minimum, but with reduced frequency resolution.

5. Press the **Center** softkey, and then turn the **Universal Knob** to select the desired center frequency.
6. Press the **Hz/div** softkey, and then turn the **Universal Knob** to select the desired resolution frequency.
7. Press the **Scale** softkey, and then turn the **Universal Knob** to select the desired vertical FFT scale
8. Press the **Reference Level** softkey, and then turn the **Universal Knob** to select the desired vertical FFT offset.
9. Press the **Unit** softkey to select the unit of vertical axis. The units of the vertical axis can be dB or Vrms which use a logarithmic scale or a linear scale to display vertical amplitude respectively. If you need to display the FFT frequency spectrum in a relatively larger dynamic range, dBVrms is recommended.
10. Press the **Display** softkey to select **Split, Full Screen or Exclusive** display mode.

- **Split:** the source channel and the FFT operation results are displayed separately. The time domain and frequency domain signals are displayed clearly.
- **Full Screen:** the source channel and the FFT operation results are displayed in the same window to view the frequency spectrum more clearly and to perform more precise measurements.
- **Exclusive:** the waveforms of channels are disabled, only the FFT operation results are displayed in the window to view the frequency spectrum more clearly and to perform more precise measurements.

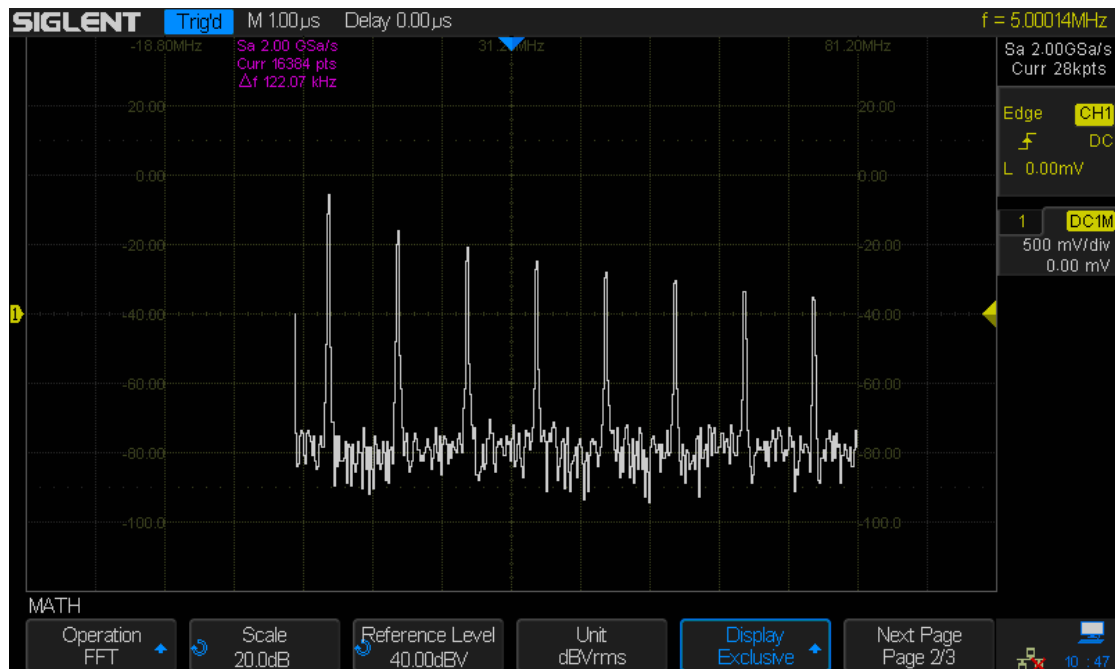

Figure 68 FFT Waveform in Exclusive Mode

11. Press the **Max Points** softkey to select the maximum number of points which are used to compute the FFT waveform.
12. Press the **Autoset** softkey to to automatically set the appropriate parameters for the FFT measurement.
13. Press the **Max-Hold** softkey to turn on or turn off the Max Hold function.

**Note:**

- Signals with DC components or deviation have increased error or deviation of the FFT waveform components. To reduce the DC components, set the Channel **Coupling** to **AC**.
- To reduce the random noise and aliasing frequency components of repetitive or single pulses, set the **Acquisition** of the oscilloscope to **Average**.

**To measure FFT waveform:**

To make cursor measurements, press the **Cursors** button, and then press the **Mode** softkey to select **On** to turn the cursors. Use the X1 and X2 cursors to measure the frequency values and the difference between two frequency values ( $\Delta X$ ). Use the Y1 and Y2 cursors to measure amplitude in dB and difference in amplitude ( $\Delta Y$ ). You can find the frequency value at the first occurrence of the waveform maximum by using the X at Max Y measurement.

Note: Please refer to the cursors chapter to learn more on cursor operation.

## Differentiate

**d/dt** (differentiate) calculates the discrete time derivative of the selected source.

$$d_i = \frac{y(i + \Delta t) - y(i - \Delta t)}{2 \Delta t}$$

Where:

- d = differential waveform.
- y = channel 1, 2, 3, or 4 data points.
- i = data point index
- $\Delta t$  = point-to-point time difference.

The **dx** option under d/dt math function operation menu shows the point-to-point time difference, and it ranges from 0.02div to 0.40div. “div” indicates the number of pixels that each division has. The SDS2000X has 50 pixels-per-division. Take 0.2div as an example:  $0.2 * 50 = 10$ .  $\Delta t$  is the point-to-point time difference of the 10 points.

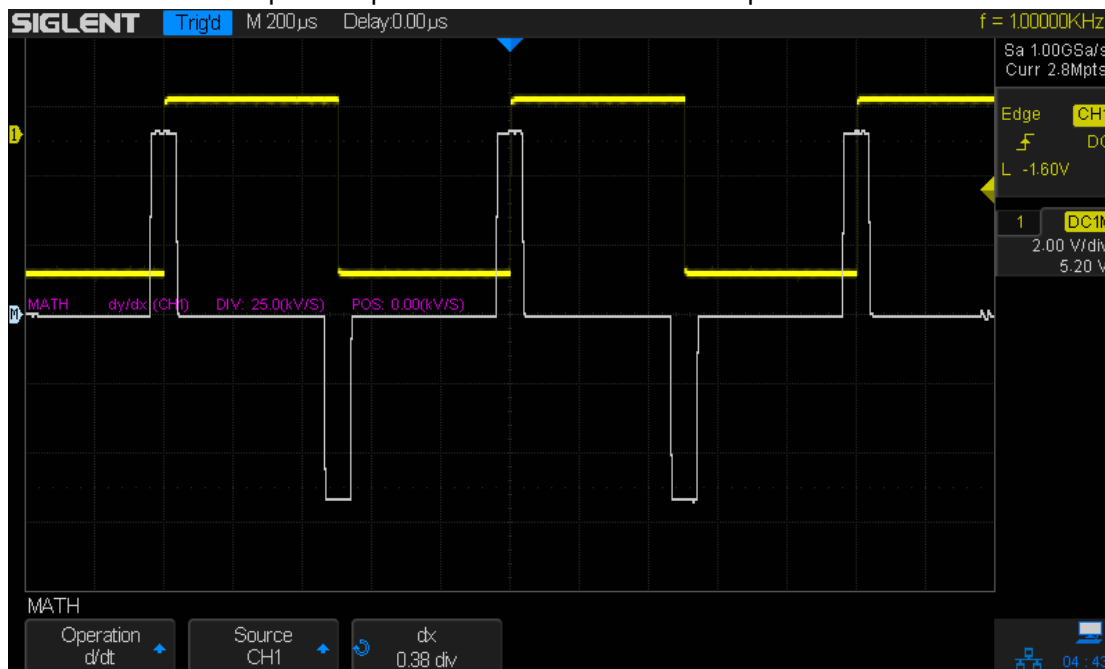

Figure 69: Differential Function Operation

You can use the differentiate function to measure the instantaneous slope of a waveform. For example, the slew rate of an operational amplifier may be measured using the differentiate function.

**Note:** Because differentiation is very sensitive to noise, it is helpful to set acquisition mode to **Average**.

## Integrate

dt (integrate) calculates the integral of the selected source. You can use integrate to calculate the energy of a pulse in volt-seconds or measure the area under a waveform. dt plots the integral of the source using the "Trapezoidal Rule". The equation is:

$$I_n = c_0 + \Delta t \sum_{i=0}^n y_i$$

Where:

- I = integrated waveform;
- $\Delta t$  = point-to-point time difference;
- y = channel 1, 2,3,4 or REFA,REFB,REFC, REFD
- $c_0$  = arbitrary constant;
- i = data point index;

The integrate operator provides an **Offset** softkey that lets you enter a DC offset correction factor for the input signal. Small DC offsets in the integrate function input (or even small oscilloscope calibration errors) can cause the integrate function output to "ramp" up or down. This DC offset correction lets you level the integrate waveform.

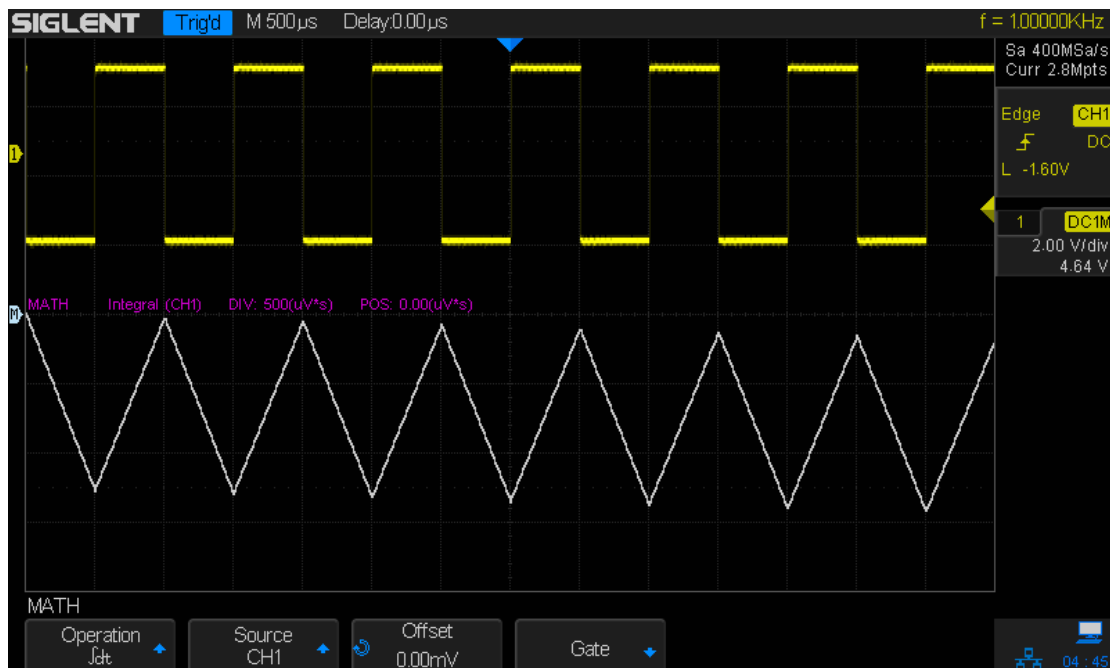

Figure 70: Integral without Offset



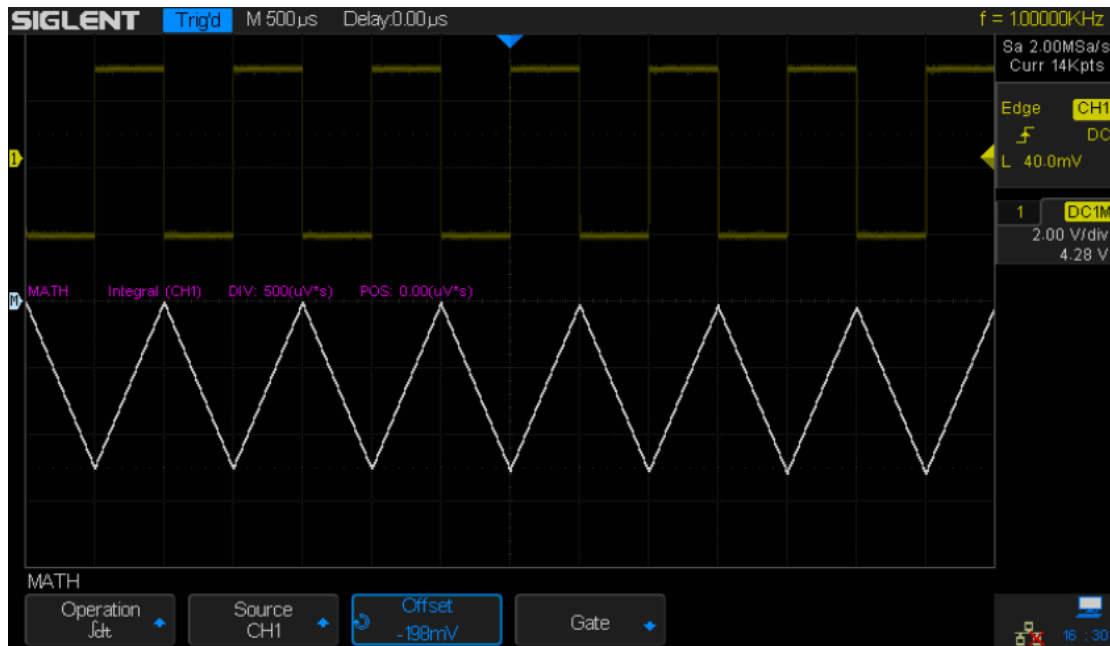

Figure 71: Integral with Offset

## Square Root

Square root ( $\sqrt{\quad}$ ) calculates the square root of the selected source.

Where the transform is undefined for a particular input, holes (zero values) appear in the function output.

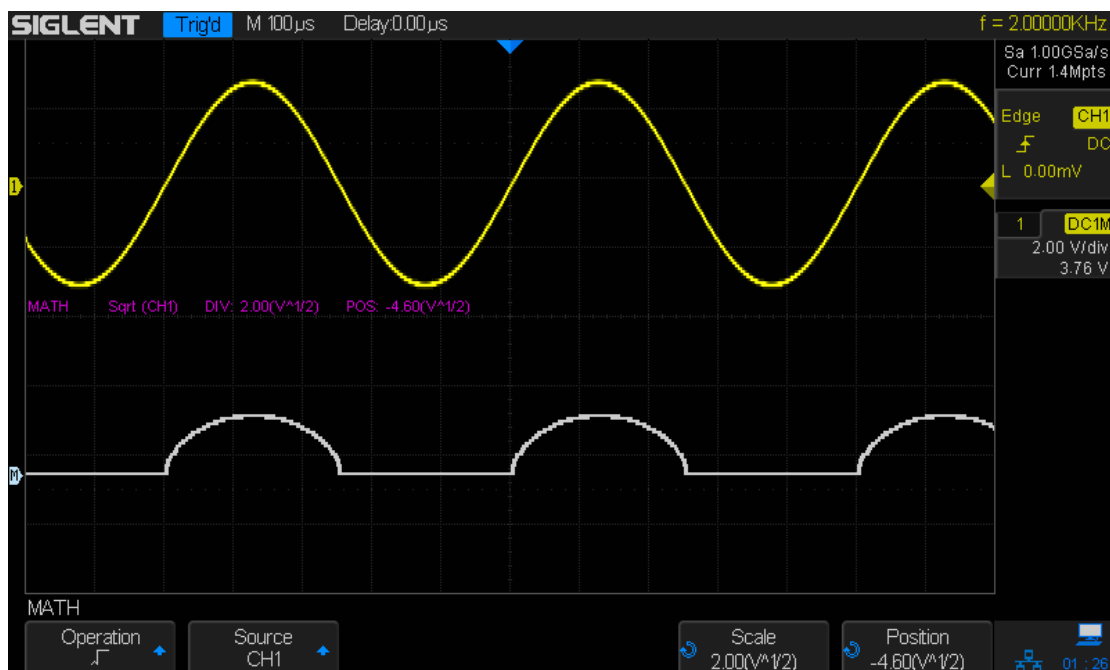

Figure 72: Square Root

## To Adjust the Math Waveform Scale and Offset

### To Adjust the Math Waveform Horizontal Scale and Offset

To check and analyze parts of a math waveform or to find an event-of-interest, you can do some horizontal and vertical adjustment.

To adjust the math waveform horizontal scale and offset

1. Turn the **Horizontal Scale Knob** on the front panel to adjust the horizontal zoom of the math waveform. The math waveform will zoom in or zoom out along with the source waveform (analog channel or reference waveform).
2. Turn the **Horizontal Position Knob** to move the math waveform horizontally. The math waveform will move left or turn right along with the source waveform (analog channel or reference waveform).

### To Adjust the Math Waveform Vertical Scale and Offset

The vertical control system on the right side of the front panel only works for the math or the reference waveforms.

1. Turn the **Ref/Math Waveform Vertical Scale Knob** on the front panel to vertically zoom in or zoom out of the math waveform.
2. Turn the **Ref/Math Waveform Vertical Position Knob** to change the vertical position of the math waveform.

---

# To Make Cursor Measurements

Cursors are horizontal and vertical markers that indicate X-axis values and Y-axis values on a selected waveform source. You can use cursors to make custom voltage and time measurements on input waveforms.

## X Cursors

X cursors are vertical dashed lines that adjust horizontally and can be used to measure time (when the source is FFT waveform, X cursors measure frequency)

**X1** cursor is the leftmost (default position) vertical dotted line; it can be moved to any place of the screen.

**X2** cursor is the rightmost (default position) vertical dotted line; it can be moved to any place of the screen.

Use the **Universal Knob** to set the **X1** and **X2** cursor values. The values at each position are displayed in the cursor box located in the upper-left corner of the screen along with the difference between X1 and X2 ( $\Delta T$ ) and  $1/\Delta T$ .

When the cursor type is set to **X1-X2**, the **Universal Knob** will move the X1 and X2 cursors together. The value under the menu option is the difference between the X1 and X2 cursors.

## Y Cursors

Y cursors are horizontal dotted lines that adjust vertically and can be used to measure voltage (V) or current (A). When the cursors source is the math function, the unit will match the math function.

**Y1** cursor is the upper (default position) horizontal dotted line; it can be moved to any vertical place on the screen.

**Y2** cursor is the lower (default position) horizontal dotted line; it can be moved to any vertical place of the screen.

Use the **Universal Knob** to set the Y1 and Y2 cursor values and the values are displayed in the cursors box in the top left corner of the screen along with the difference between Y1 and Y2 ( $\Delta Y$ ).

When the cursor type is set to **Y1-Y2**, the **Universal Knob** will move the Y1 and Y2 cursors together. The value under the menu option is the difference between the Y1 and Y2 cursors.

## To Make Cursor Measurements

1. Press the **Cursors** button on the front panel to enter the CURSOR function menu.
2. Press the **Mode** softkey and set the option to **On**.
3. Press the **Source** softkey, and then use the **Universal Knob** to select the desired source. Only analog channels (CH1~4), math waveforms and reference waveforms (REFA, REFB, REFC, REFD) that are displayed are available for cursors.
4. To make cursor measurements:
  - To measure the horizontal time, use the **Universal Knob** to move the X1 and X2 cursors to desired place. If necessary, set the cursor type to **X1-X2** and move the X1 and X2 cursors together.
  - To measure vertical voltage or current, use the **Universal Knob** to move the Y1 and Y2 cursors to the desired position. If necessary, set the cursor type to "Y1-Y2" and move the Y1 and Y2 cursors together.
  - To adjust the transparency of the cursors message box, press the **Display/Persist** button and go to the second page, press the **Transparence** (20% to 80%) softkey and then turn the **Universal Knob** to adjust the transparence to the desired value.

### Cursor examples:

1. Use cursors to measure pulse width:

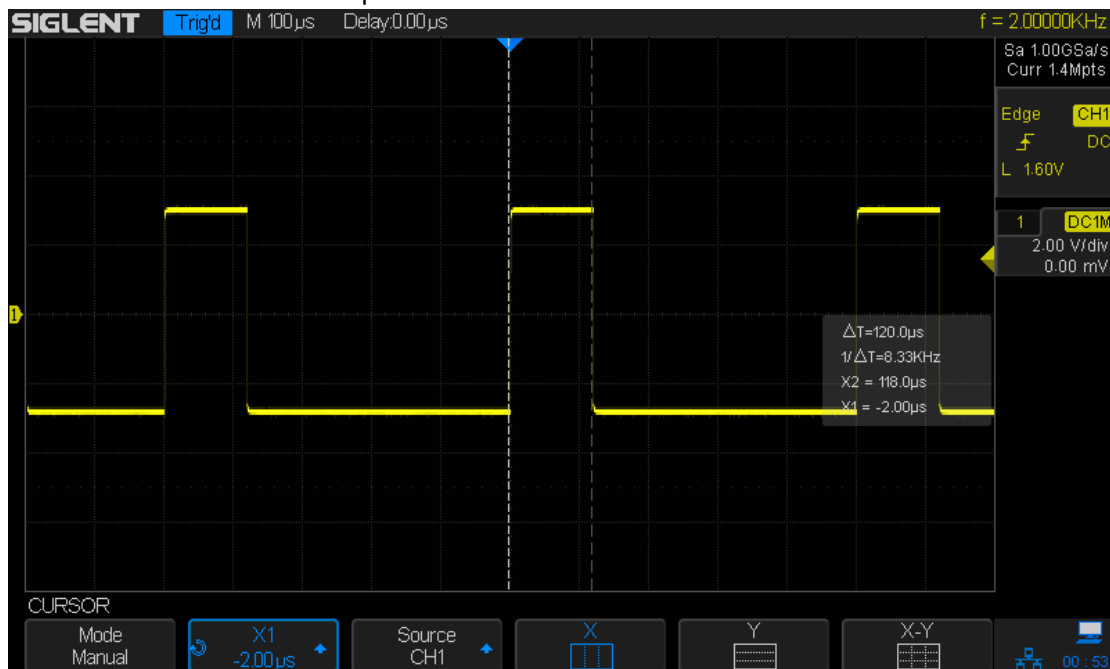

Figure 73: Measure Pulse Width

---

# To Make Measurements

SDS2000X provides measurements of 36 waveform parameters as well as basic statistics on those measured values. It contains voltage, time and delay parameters.

Voltage and time parameters are under the Type option. The results of the last five selected measurements are displayed at the bottom of screen and above the menu. Delay parameters are under the **All Measure** submenu. Set the Delay option to On to display all the delay parameters.

The contents of this chapter:

- ◆ [Type of Measurements](#)
  - [Voltage Measurements](#)
  - [Time Measurements](#)
  - [Delay Measurements](#)
- ◆ [To Make Automatic Measurement](#)
- ◆ [To Clear Measurements Parameters](#)
- ◆ [To Make All Measurement](#)

## Type of Measurement

### Voltage Measurements

Voltage measurements include 15 kinds of voltage parameter measurements.

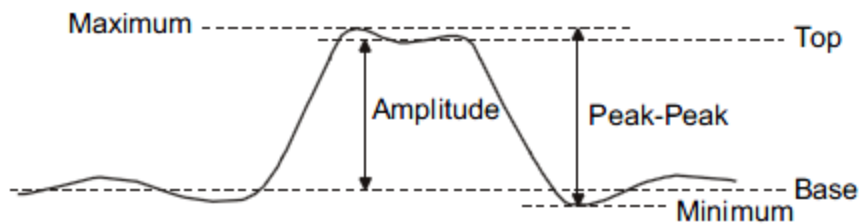

Figure 74: Voltage Measurements

1. **Pk-Pk:** The peak-to-peak value is the difference between Maximum and Minimum values.
2. **Vmax:** Maximum is the highest value in the waveform display.
3. **Vmin:** Minimum is the lowest value in the waveform display.
4. **Vamp:** The Amplitude of a waveform is the difference between its Top and Base values.
5. **Vtop:** The Top of a waveform is the mode (most common value) of the upper part of the waveform, or if the mode is not well defined, the top is the same as Maximum.
6. **Vbase:** The Base of a waveform is the mode (most common value) of the lower part of the waveform, or if the mode is not well defined, the base is the same as Minimum. The Y cursor shows the value being measured.
7. **Vmea:** The arithmetic mean over the first cycle of the waveform.
8. **Mean:** The arithmetic over the entire waveform.
9. **Stdev:** Standard deviation of all data values
10. **Vstd:** Standard deviation of all data values in the first cycle
11. **Vrms:** The true Root Mean Square voltage over the entire waveform.
12. **Crms:** The true Root Mean Square voltage of the first cycle in the waveform.
13. **Overshoot:** Overshoot is distortion that follows a major edge transition expressed as a percentage of Amplitude. ROV means rising edge overshoot and FOV means falling edge overshoot.

$$\text{Rising edge overshoot} = \frac{\text{local Maximum} - \text{D Top}}{\text{Amplitude}} \times 100$$

$$\text{Falling edge overshoot} = \frac{\text{Base} - \text{D local Minimum}}{\text{Amplitude}} \times 100$$

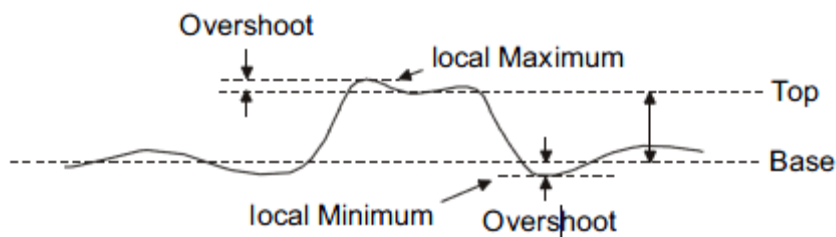

Figure 75: Overshoot

- 14. Preshoot:** Preshoot is distortion that precedes a major edge transition expressed as a percentage of Amplitude. The X cursors show which edge is being measured (edge closest to the trigger reference point).

$$\text{Rising edge preshoot} = \frac{\text{local Minimum} - D \text{ Top}}{\text{Amplitude}} \times 100$$

$$\text{Falling edge preshoot} = \frac{\text{Base} - D \text{ local Minimum}}{\text{Amplitude}} \times 100$$

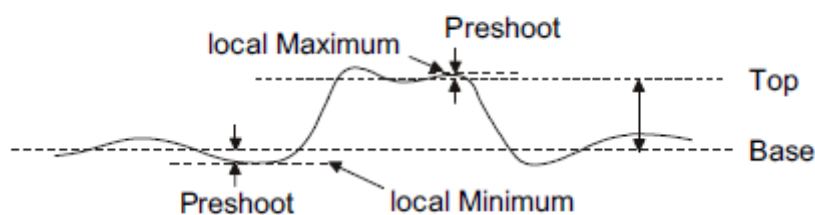

Figure 76: Preshoot

- 15. L@T:** The voltage value of the trigger point  
**16. +SR:** Slew rate of the rising edge from 10%-90%  
**17. -SR:** Slew rate of the falling edge from 10%-90%

## Time Measurements

Time measurements include 9 kinds of time parameter measurements.

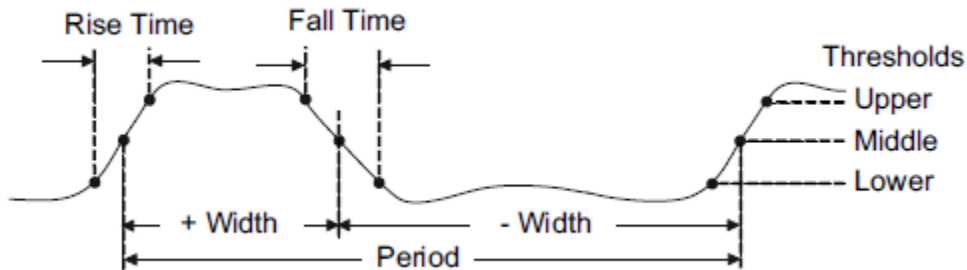

Figure 77: Time Measurements

1. **Period:** Defined as the time between the middle threshold points of two consecutive, like-polarity edges.
2. **Frequency:** Defined as the reciprocal of period.
3. **+ Width:** The time difference between the 50% threshold of a rising edge to the 50% threshold of the next falling edge of the pulse.
4. **-Width:** The time difference between the 50% threshold of a falling edge to the 50% threshold of the next rising edge of the pulse.
5. **Rise Time:** The time for the signal amplitude to rise from 10% to 90%.
6. **Fall Time:** The time for the signal amplitude to fall from 90% to 10%.
7. **BWid:** The duration of a burst over the entire waveform.
8. **+ Duty:** The ratio of the positive pulse width to the period.
9. **-Duty:** The ratio of the negative pulse width to the period.
10. **Delay:** Time from the trigger to the first transition at the 50% crossing.
11. **T@M:** Time from trigger of each transition at a specific level and slope.



---

## Delay Measurements

Delay measurements measure the time-based values between any two channels.

1. **Phase:** The phase difference between two channels.
2. **FRR:** The time between the first rising edge of source 1 and the first rising edge of source 2 of 50 voltage level.
3. **FRF:** The time between the first rising edge of source 1 and the first falling edge of source 2 of 50 voltage level.
4. **FFR:** The time between the first falling edge of source 1 and the first rising edge of source 2 of 50 voltage level.
5. **FFF:** The time between the first falling edge of source 1 and the first falling edge of source 2 of 50 voltage level.
6. **LRR:** The time between the last rising edge of source 1 and the last rising edge of source 2 of 50 voltage level. **LRR:** The time between the last rising edge of source 1 and the last falling edge of source 2 of 50 voltage level.
7. **LRF:** The time between the last rising edge of source 1 and the last falling edge of source 2 of 50 voltage level.
8. **LFR:** The time between the last falling edge of source 1 and the last rising edge of source 2 of 50 voltage level.
9. **LFF:** The time between the last falling edge of source 1 and the last falling edge of source 2 of 50 voltage level.

## To Make Automatic Measurements

Perform the steps below and select voltage or time parameters to make automatic measurements.

1. Press the **Measure** button on the front panel to enter the MEASURE function menu..
2. Press the **Source** softkey, and then use the **Universal Knob** to select the desired channel. Only analog channels (CH1~4) that are displayed are available for measurements.
3. To select and display measurement parameters. Press the **Type** softkey, and then turn the **Universal Knob** to select the desired measurement parameter.
4. Press the **Universal Knob** to add the measurement parameter, the parameters and value will be shown above the menu, and the statistics status will update.
5. To turn off the statistics function, press the **Statistics** softkey to select **Off**.

The measurement display area can display 4 measurement parameters at most, and the measurements will arrange according to the selection order. If a fifth measurement parameter is added, the first measurement will be deleted.



Figure 78: Select the Measurement Parameter

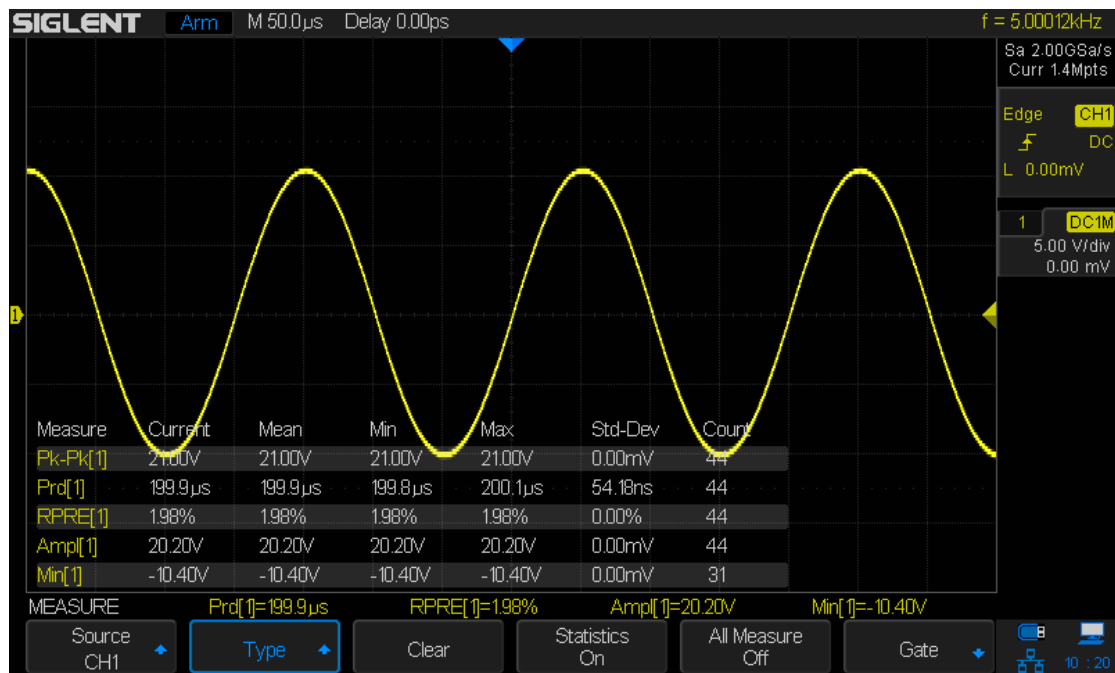

Figure 79: Add the Measurement

Note: If the parameter does not match the measured condition, it will display as "\*\*\*\*\*".

## To Clear Measurement Parameters

Press the **Clear** softkey to clear all the measurement parameters that are displayed on the screen.

## To Make All Measurement

All measurements can measure all the voltage, time and delay parameters of the current measurement source. The table of results will be displayed on the screen.

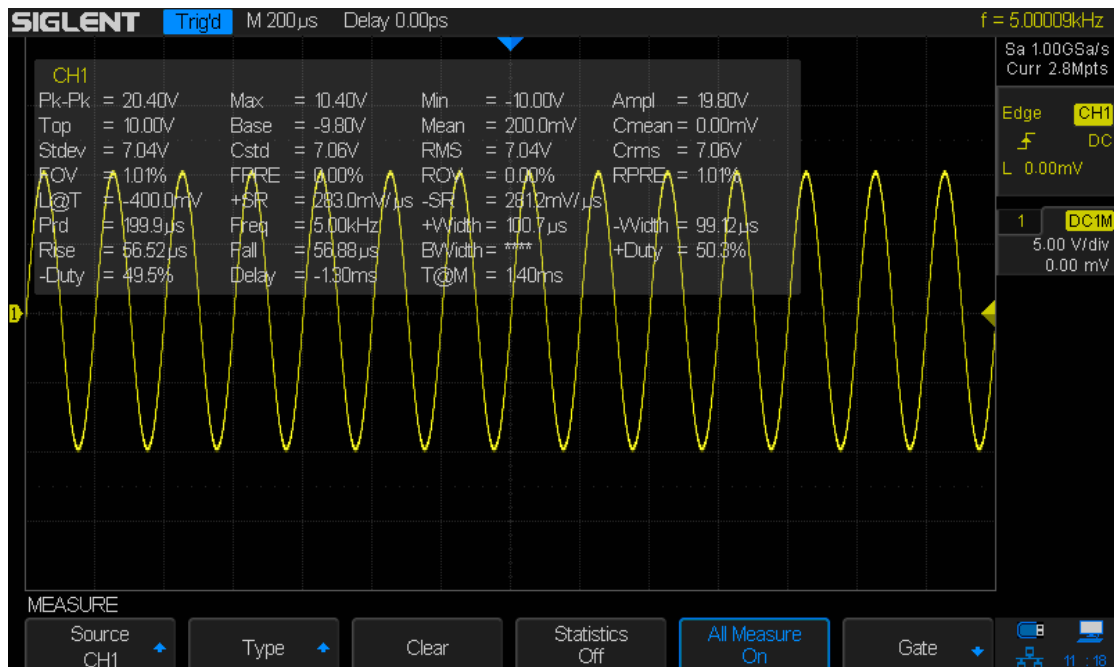

Figure 80: All Parameters Measurement

Do the following steps to activate the All Parameters display:

1. Press the **Measure** button on the front panel to enter the MEASURE function menu.
2. Press the **All Measure** softkey to select **On**.
3. Press the **Source** softkey to select the measure source (CH1~4, MATH, REFA, REFB, REFC, REFD).

# Display Setting

The display type, color, persistence, grid type, waveform intensity, grid brightness and transparency are all adjustable.

The contents of this chapter:

- ◆ [To Set Display Type](#)
- ◆ [To Set Color Display](#)
- ◆ [To Set and Clear Persistence](#)
- ◆ [To Clear the Display](#)
- ◆ [To Select Grid Type](#)
- ◆ [To Adjust the Waveform Intensity](#)
- ◆ [To Adjust Grid Brightness](#)
- ◆ [To Adjust Transparency](#)

## To Set Display Type

Press the **Display** button on the front panel, and then press the **Type** softkey to select **Vectors** or **Dots** display type.

- **Vectors:** the sample points are connected by lines and displayed. Normally, this mode can provide the most vivid waveform to view the steep edge of the waveform (such as square waveform).
- **Dots:** display the sample points directly. You can directly view each sample point and use the cursor to measure the X and Y values of the sample point.

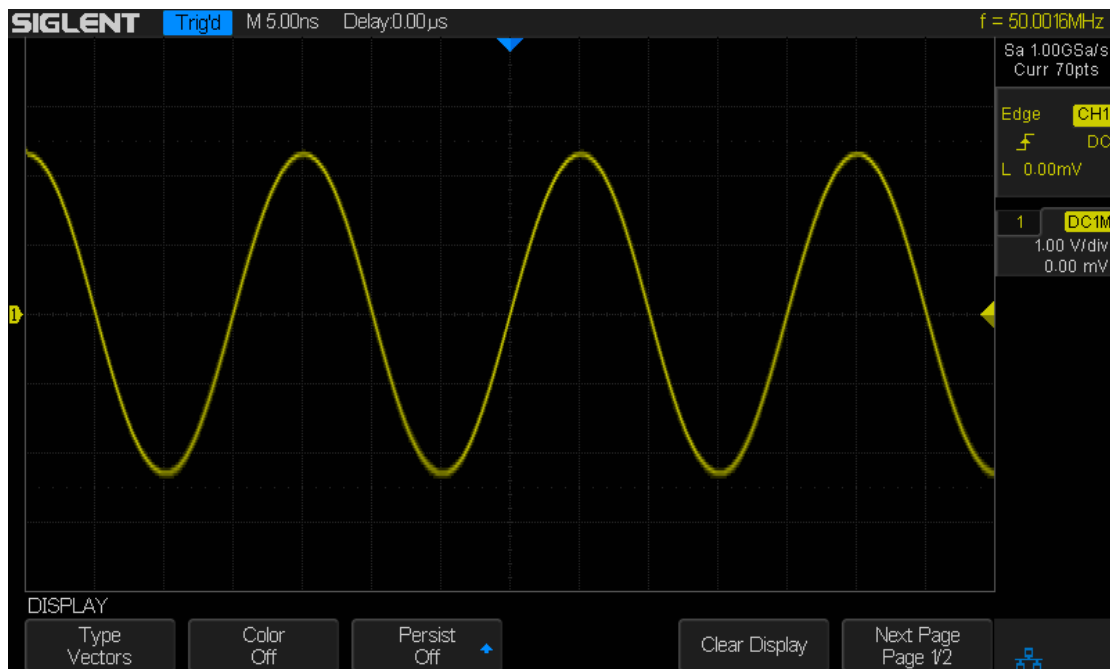

Figure 81: Vectors Display



Figure 82: Dots Display

## To Set Color Display

Color temperature mode uses the change of the waveforms' color to reflect the change of the waveforms' appearing probability. This mode uses a change in color instead of the more common change in intensity. The greater the probability that the waveform appears, the warmer the color is; the smaller the probability that the waveform appears, the colder the color is.

The picture below shows the change of color from cold to warm. Press the Display button on the front panel, and then press the **Color** softkey and set the option to **On** to turn on the color temperature function. You can compare the waveform's color with the picture below to just the probability that the waveform appears.

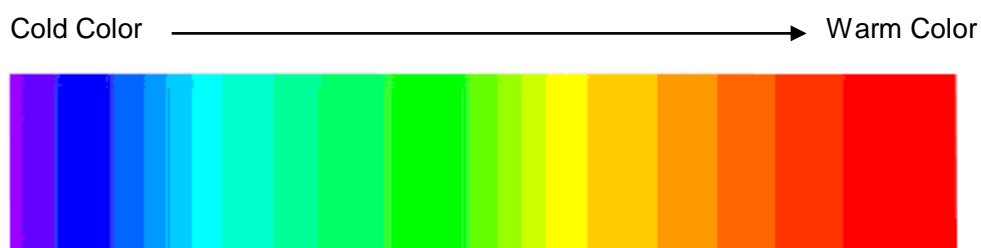

Figure 83: Color Temperature

## To Set and Clear Persistence

With persistence, the oscilloscope updates the display with new acquisitions, but does not immediately erase the results of previous acquisitions. All previous acquisitions are displayed with reduced intensity. New acquisitions are shown in their normal color with normal intensity. This mode is useful for capturing infrequent events and spurious signals.

Do the following steps to set and clear persistence:

1. Press the **Display/Persist** button on the front panel to enter the DISPLAY function menu.
2. Press the **Persist** softkey; then turn the **Universal Knob** to select the desired option.
  - **Off**—turn off persistence.
  - Variable persistence time (1 second, 5 seconds, 10 seconds, 30 seconds) — Sets the persistence time. The results of previous acquisitions are erased after the set time expires.
  - **Infinite**—select “Infinite” Results of previous acquisitions are never erased. Use infinite persistence to measure noise and jitter, to see the worst-case extremes of varying waveforms, to look for timing violations, or to capture events that occur infrequently.



Figure 84: Persist Set to Infinite

3. When the **Persist** is **On**, to erase the results of previous acquisitions from the display, press the **Clear Persist** softkey. The oscilloscope will start to accumulate acquisitions again.
4. To return to the normal display mode, turn off persist and the previous acquisitions will be clear at once.

## To Clear the Display

Press the Display button on the front panel to enter the DISPLAY function menu; press the **Clear Display** softkey to clear all the waveforms displaying on the screen, acquire and display new waveforms.





## To Select Grid Type

To select grid type

1. Press the **Display/Persist** button on the front panel to enter the DISPLAY function menu.
2. Press the **Next Page** softkey to go to the second page of the Display function menu.
3. Press the **Grid** softkey; and then turn the **Universal Knob** to select the desired grid type. Press the **Grid** softkey continually can also select the grid type.

There are 5 kinds of grid types that are available. Select the grid type according to your preference.

 Display 14X8 grid type

 Display 2X2 grid type

 Display without grid

## To Adjust Waveform Intensity

Do the following steps to adjust waveform intensity:

1. Press the **Display/Persist** button on the front panel to enter the DISPLAY function menu.
2. Press the **Next Page** softkey to go to the second page of the Display function menu.
3. Press the **Intensity** softkey; and then turn the **Universal Knob** to select the desired value. The default value is 50%, and the range is from 0% to 100%.

Increasing the intensity lets you see the maximum amount of noise and infrequently occurring events. Reducing the intensity can expose more detail in complex signals as shown in the following figures.



Figure 85: Intensity Set to 100%

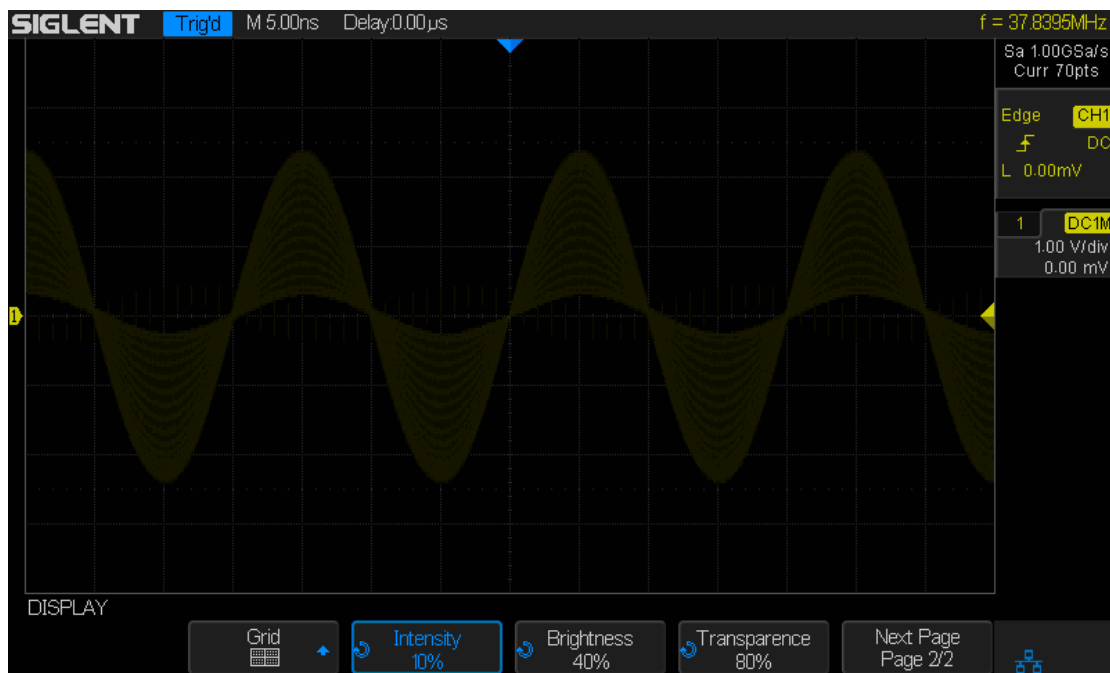

Figure 86: Intensity Set to 10%

Note: Waveform intensity adjustment affects analog channel waveforms only (not math waveforms, reference waveforms, digital waveforms, etc.).

---

## To Adjust Grid Brightness

Do the following steps to adjust the grid brightness:

1. Press the **Display** button on the front panel to enter the DISPLAY function menu.
2. Press the **Next Page** softkey to go to the second page of the Display function menu.
3. Press the **Brightness** softkey; and then turn the **Universal Knob** to select the desired value. The default value is 40%, and the range is from 0% to 100%.

## To Adjust Transparence

Transparence can be used to adjust the transparency of the message box of cursor, measure, Pass/Fail and all pop-up menus to an appropriate value to observe the date more conveniently.

Under Cursor or Measure or any other menu operation, if want to change the transparency of the message box, do the following steps:

1. Press the **Display** button on the front panel to enter the DISPLAY function menu.
2. Press the **Next Page** softkey to go to the second page of the Display function menu.
3. Press the **Transparence** softkey; and then turn the **Universal Knob** to select the desired value. The default value is 50%, and the range is from 0% to 100%.

# Save and Recall

Oscilloscope setups, waveforms, pictures, and CSV files can be saved to internal oscilloscope memory or to a USB storage device. The saved setups, waveforms can be recalled later. SDS2000X provides an USB Host interface on the front panel to connect an USB device for external storage.

The contents of this chapter

- ◆ [Save Type](#)
- ◆ [Internal Save and Recall](#)
- ◆ [External Save and Recall](#)
- ◆ [Disk Management](#)

---

## Save Type

SDS2000X supports setups, waveforms, pictures and CSV files storage. The default save type is setups.

### 1. Setups

It's the default storage type of SDS2000X. SDS2000X saves the settings of the oscilloscope in internal or external memory in "\*.SET" format. At most 20 setting files (from No.1~No.20) can be stored in internal memory. The stored settings can be recalled.

### 2. Reference

SDS2000X saves the waveform data in memory in "\*.REF" format. At recall, the reference waveform will be displayed on the screen directly.

### 3. Binary

SDS2000X saves the waveform data in memory in "\*.BIN" format.

### 4. BMP

SDS2000X saves the screen image in external memory in "\*.bmp" format. You can specify the file name and saving directory under the same directory using the same file name. The oscilloscope cannot recall/open image files.

### 5. CSV

SDS2000X saves the waveform data to an external memory source in "\*.CSV" format. The stored files contain the waveform data of the displayed analog channels and the main setting information of the oscilloscope. The oscilloscope cannot recall/open CSV files.

Set the save type to **CSV**, and set the **Para Save** option to **On** or **Off** to turn on or off the parameters storage function.

### 6. MATLAB

SDS2000X saves the waveform data in memory in "\*.DAT" format.

## Internal Save and Recall

Internal save and recall support Setups in **Save/Recall**. In the following part, the save and recall method and procedures are introduced.

➤ **Save the specified oscilloscope setting in internal memory.**

1. Connect the signal to the oscilloscope and obtain stable display.
2. Press **Save/Recall** button on the front panel to enter the SAVE/RECALL function menu.
3. Press the **Save** softkey to enter the SAVE function menu.
4. Press the **Type** softkey and then turn the **Universal Knob** to select **Setups**; and then press the knob to confirm.
5. Press the **Save To** softkey to select **Internal** to save the current setup of the oscilloscope to the internal memory.
6. Press the **Setup** softkey button, and then turn the **Universal Knob** to select the location to save. The internal memory can save as many as 20 setup files, from No.1~No.20.
7. Press the **Save** softkey to save the current setup to the appointed location. After a few seconds, it will pop-out the message “**Store Data success!**”

➤ **Load the specified type of file in internal memory.**

If want to recall the setup after having finished the steps above, please do the following steps:

1. Return to the SAVE/RECALL function menu.
2. Press the **Recall** softkey to enter the RECALL function menu.
3. Press the **Setup** softkey, and then turn the **Universal Knob** to select the location that you want to recall, press the **Recall** softkey to recall the setup, and it will pop-out the message “**Read Data Success!**”

Note: To delete a setup file in memory, please save a new setup to the same location to overwrite it.

## External save and recall

Before using external storage and recall, make sure that the USB flash device is connected correctly. External storage supports all available file types. The oscilloscope cannot recall/save **Picture** or **CSV** file types.

➤ **Save the specified type of file to the external USB flash device.**

1. Press the **Save/Recall** button on the front panel to enter the SAVE/RECALL function menu.
2. Press the **Save** softkey to enter the SAVE function menu
3. Press the **Type** softkey to select **Waveforms** or **Setup**
4. Press the **Recall** softkey to enter the SAVE/RECALL file system.

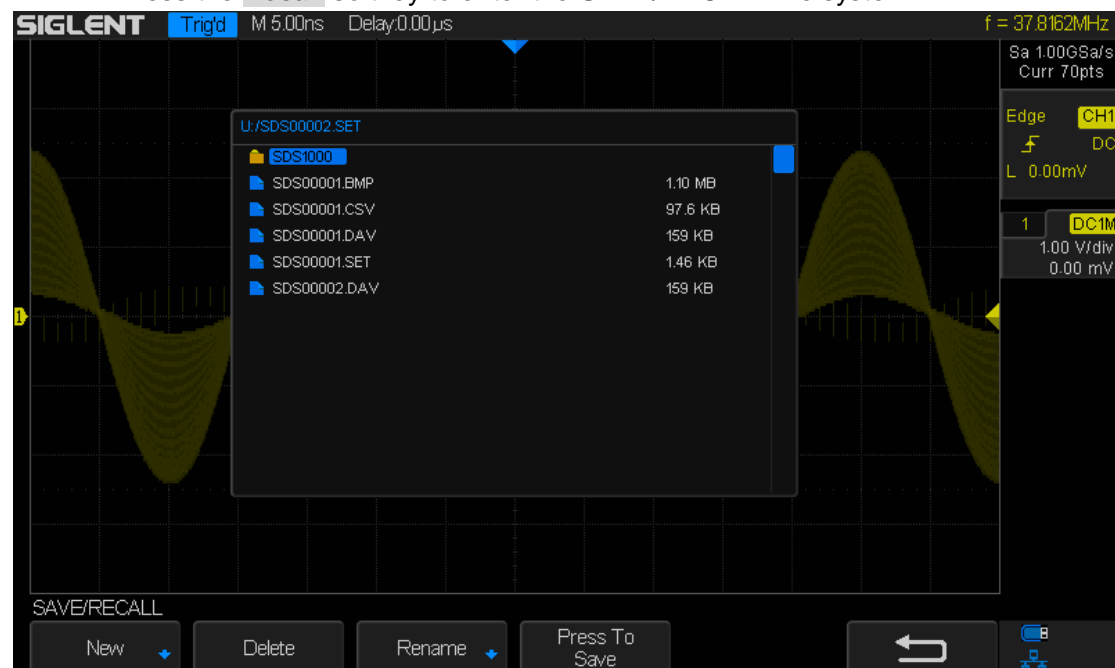

Figure 87: SAVE/RECALL File System

5. Use the **Universal Knob** to select the desired location. File can be stored under the root directory or in a certain folder under the root directory of the USB storage device.

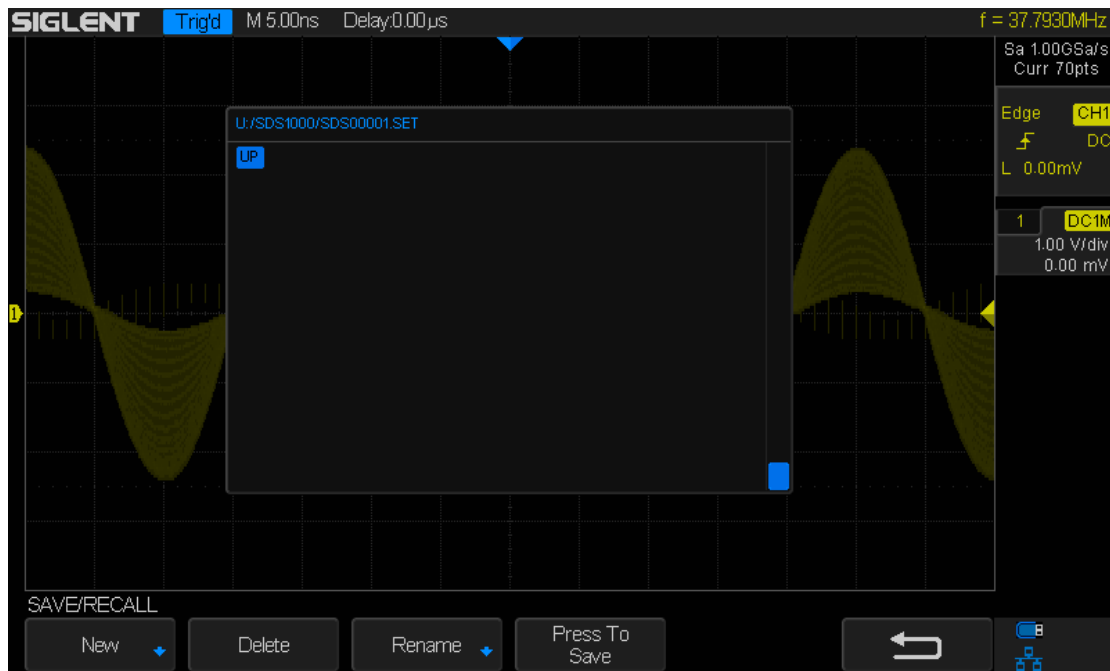

Figure 88: Select Save Location

6. After the save position is selected, press the **New** softkey to turn on the interface as shown in the figure below. Refer to the descriptions in “**To Create a new file or fold**” to create a new file name.

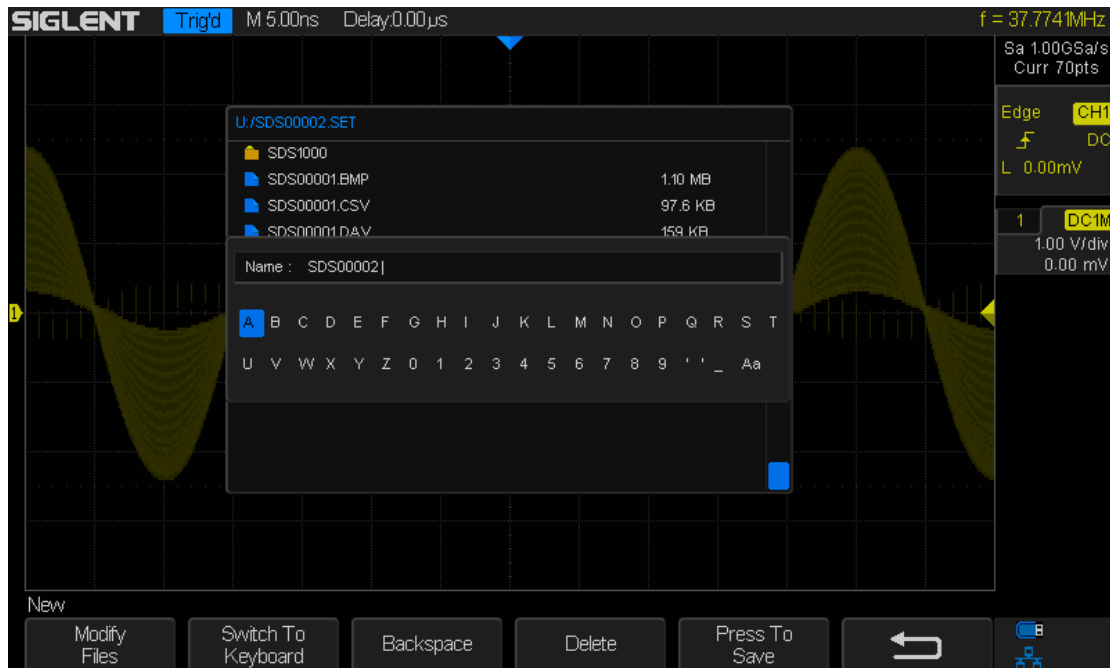

Figure 89: File Name Dialogue

7. Press the Enter softkey to save the current waveform to the external USB storage device,



- 
- **Load the specified type of file in the external USB storage device.**
1. Press the **Save/Recall** button on the front panel to enter the SAVE/RECALL function menu.
  2. Press the **Recall** softkey to enter the RECALL function menu.
  3. Press the **Type** softkey to select **Reference** or **Setups**
  4. Press the **Recall** softkey to enter the SAVE/RECALL file system.
  5. Turn the **Universal Knob** to select the file to be recalled, press the **Press To Recall** softkey to recall the specified file..

## Disk Management

Disk management is used in save and recall operations after the oscilloscope is connected to a USB storage device. Before using an external disk, make sure that the USB storage device is connected correctly.

Execute the following operations through the disk management menu:

- ◆ [To Create a New File or Folder](#)
- ◆ [To Delete a File or Folder](#)
- ◆ [To Rename a File or Folder](#)

## To Create a New File or Folder

This operation is only valid in external storage. The SDS2000X supports English alphabet characters, letters, numbers, underscores and spaces. Let's use an example to introduce how to create a file or folder.

Example: create a file or folder named "SDS2013ab"

1. Press the **Save/Recall** button on the front to enter the SAVE/RECALL function menu.
2. Press the **Save** softkey (or **Recall** softkey) to enter the SAVE (or RECALL) function menu.
3. Press the **Type** softkey, and then turn the **Universal Knob** to select one of the type (if select **Setups**, please set the **Save To** option to **External**).
4. Press the **Press To Save** softkey (or **Press To Recall** softkey) to enter the SAVE/RECALL file system.

Press the **Modify** softkey to select **File** or **Folder**, and then press the **New** softkey to open the interface shown as the picture below. It divides into two parts: Name input area and keyboard area. The default is name input area. As the picture shows below, "aA" is used to switch upper-lower case.

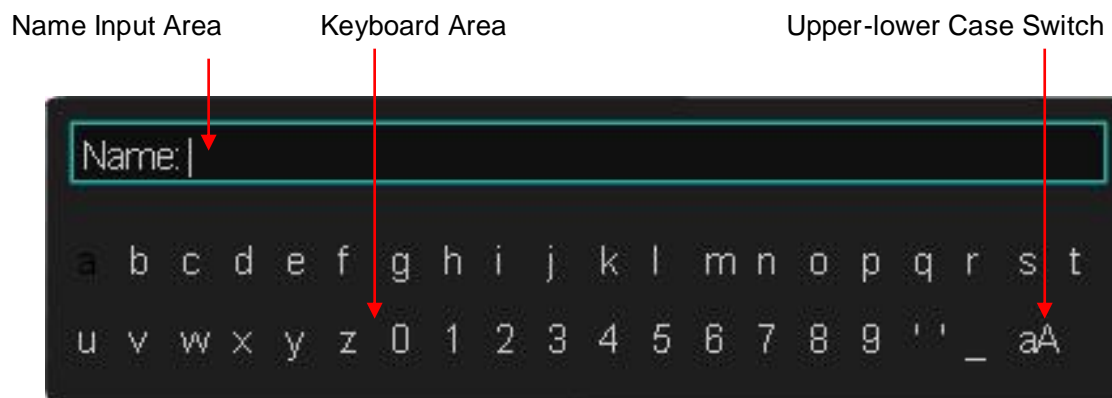

Figure 90: Input Keyboard

5. To delete the name in the name input area, press the **Delete** softkey continuously to delete the character one-by-one.
6. To input a new name, press the **Switch To** softkey to switch to the keyboard area. The default input method is lower case.
7. Press the **←** or the **→** softkey or turn the **Universal Knob** to select "aA", and then press the **Enter** softkey or push down the **Universal Knob** to set it to "Aa" to set the input method to upper case.
8. Press the **←** or the **→** softkey or turn the **Universal Knob** to select "S" and then press the Enter softkey or the Universal Knob to input the character. Use the same steps to enter the characters "DS2013".
9. Press the **←** or the **→** softkey or turn the **Universal Knob** to select "Aa", and then press the **Enter** softkey or the **Universal Knob** to set it to "aA" to set the input method to lower case.
10. Use the method in step 8 to enter the characters "ab".

11. Press the **Enter** softkey to enter the file name. You will see a file or folder named “SDS2013ab”.

## To delete a file or folder

This operation is only valid in external storage.

1. Press the **Save/Recall** button on the front to enter the SAVE/RECALL function menu.
2. Press the **Save** softkey (or **Recall** softkey) to enter the SAVE (or RECALL) function menu.
3. Press the **Type** softkey, and then turn the **Universal Knob** to select one of the type (if select Setups, please set the **Save To** option to **External**).
4. Press the **Press To Save** softkey (or **Press To Recall** softkey) to enter the SAVE/RECALL file system.
5. Turn the **Universal Knob** to select the file or folder to be deleted, and then press the **Delete** softkey. Then the file or folder will be deleted.

## To rename a file or a folder

This operation is only valid in external storage.

1. Press the **Save/Recall** button on the front to open the SAVE/RECALL function menu.
2. Press the **Save** softkey (or **Recall** softkey) to enter the SAVE (or RECALL) function menu.
3. Press the **Type** softkey, and then turn the **Universal Knob** to select one of the type (if select Setups, please set the **Save To** option to **External**).
4. Press the **Press To Save** softkey (or **Press To Recall** softkey) to enter the USB storage device interface.
5. Press the **Next Page** softkey to go to the second page of the SAVE/RECALL function menu.
6. Press the **Rename** softkey, and then refer to the descriptions in “**To Create a new file or fold**” to create a new file name.

---

# System Function Setting

This function module supports the oscilloscope's system-related functions, such as system status, language, sound and other advanced settings. It allows access to self-calibration, firmware update and remote interface configuration.

The contents of this chapter:

- ◆ [To View the System Status](#)
- ◆ [To Do Self-Calibration](#)
- ◆ [To Enable or Disable the Sound](#)
- ◆ [To Specify the Language](#)
- ◆ [To Enable Pass/Fail Test](#)
- ◆ [I/O Set](#)
- ◆ [To Do Power Analysis](#)
- ◆ [To Enable Quick-Cal](#)
- ◆ [To Update Firmware or configuration](#)
- ◆ [To Perform a Self Test](#)
- ◆ [To Specify the Screen Saver Time](#)
- ◆ [Option Management](#)

## To View the System Status

Do the following steps to view the system status:

1. Press the **Utility** button on the front to enter the UTILITY function menu.
2. Press the **System Status** softkey to view the system status of the oscilloscope. The system status includes the information below:
  - **Startup Times:** Displays the number of boot-strap routines of the oscilloscope.
  - **Software Version:** Lists the current software version of the oscilloscope.
  - **FPGA Version:** Lists the current FPGA version of the oscilloscope.
  - **Hardware Version:** Lists the current hardware version of the oscilloscope.
  - **Product Type:** Displays the product type of the oscilloscope.
  - **Serial NO.:** Lists the serial number of the oscilloscope.
  - **Scope ID:** Displays the identification of the oscilloscope.



Figure 91: System Status

3. Press the **Single** button on the front panel to exit.

## To Do Self-Calibration

The self-calibration program quickly enables the oscilloscope to utilize the best working state and to provide the most precise measurement values. You can perform self-calibration at any time, especially when there has been a change in the external ambient temperature of 5 °C or more. Make sure that the oscilloscope has been warmed up or operated for more than 30 minutes before performing the self-calibration.

Do the following steps to perform self-calibration:

1. Disconnect all the input channels.
2. Press the **Utility** button on the front panel, and then press the **Do Self Cal** softkey, and the oscilloscope will pop-out the message box shown as below:





Figure 92: Do Self Cal

3. Press the **Single** button on the front panel to perform the self-calibration program. During the calibration, most of the keys are disabled.
4. When the self-calibration program is finished, it will display the message “**press Run/Stop key to exit**”. Press the **Run/Stop** button on the front panel to exit the calibration interface.

## To Enable or Disable the Sound

When the sound is enabled, the sound of the beeper will be heard when a function key or a menu softkey is pressed or when the prompt message pops up.

Press the **Utility** button on the front panel to enter the UTILITY function menu; then press **Sound** softkey to select  or  to turn on or off the sound.

## To Specify the Language

SDS2000X supports multiple language menus, Chinese/English help and prompt messages.

1. Press **Utility** button on the front panel to enter the UTILITY Function menu.
2. Press the **Language** softkey; and then turn the **Universal Knob** to select the desired language. Then push down the knob to select the language.

The languages that currently available are Simplified Chinese, Traditional Chinese, English, French, German, Spanish, Russian, Italian, and Portuguese.



## To Enable Pass/Fail Test

One way to verify a waveform's compliance to a particular set of parameters is to use pass/fail testing. A pass/fail defines a region of the oscilloscope's display in which the waveform must remain in order to comply with chosen parameters. Compliance to the mask is verified point-by-point across the display.

The test results can be displayed on the screen as well as be declared through the system sound or the pulse signal output from the **[TRIG OUT]** connector at the rear panel.

Pass/Fail test operates on displayed analog channels; it does not operate on channels that are not displayed.

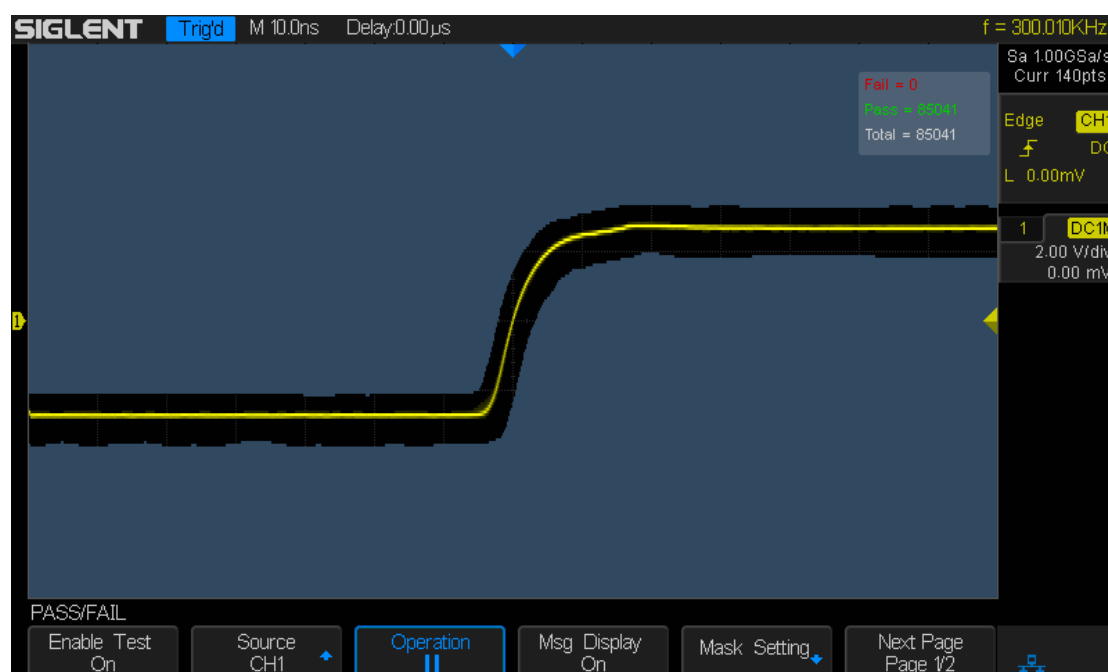
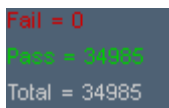

Figure 93: Pass/Fail Test





## To Set and Perform Pass/Fail Test

Do the following steps to set and perform pass/fail test:

1. Press the **Utility** button on the front panel to enter the UTILITY function menu.
2. Press the **Next Page** softkey to go to the second page of the UTILITY function menu.
3. Press the **Pass/Fail** softkey to enter the PASS/FAIL function menu.
4. Press the **Enable Test** softkey to select **On** to enable the pass/fail test.
5. Press the **Source** softkey to select the desired channel.
6. Press the **Mask Setting** softkey to enter the MASK function menu.
7. Press the **X Mask** or **Y Mask** softkey; and then turn the **Universal Knob** to select the desired value. The range is from 0.02div to 4div.
8. Press the **Create Mask** button to create the mask. Whenever the **Create Mask** softkey is pressed the old mask is erased and a new mask is created.
9. Press the **UP** softkey to return to the PASS/FAIL function menu.
10. Press the **Msg Display** to select **On** or **Off** to turn on or off the message display. When **On** is selected, the test result will be displayed in the upper-right message box of the screen.



```
Fail = 0
Pass = 34985
Total = 34985
```

- **Fail:** Msg Display shows the number of times the oscilloscope trace has triggered the trace gone outside of the mask area.
  - **Pass:** Msg Display shows the number of times the oscilloscope trace has triggered the trace stayed within the mask area.
  - **Total:** the frame number of the channel waveform that have been acquired. It is the total of **Pass** and **Fail**.
11. Press the Next Page softkey to go to the second page of the PASS/FAIL menu.
  12. Press the Fail softkey to select On or Off to turn on or off the function.
    - **On:** When failed waveforms are detected, the oscilloscope will stop the test and enter the STOP state. At this point, the results of the test remain the same on the screen (if display is turned on) and only one pulse is output from the **[TRIG OUT]** connector (if enabled) at the rear panel.
    - **Off:** The oscilloscope will continue with the test even though failed waveforms are detected. The test results on the screen will update continuously and a pulse will be output from the **[Trigger Out]** connector at the rear panel each time a failed waveform is detected.
  13. Press the Output softkey to select turn on or off the sound.
    -  : When the failed waveforms are detected, the beeper sounds.
    -  : The beeper will not sound even if the failed waveforms are detected,
  14. Press the Next Page softkey to return to the first page of the PASS/FAIL menu.
  15. Press the Operate softkey to perform the test.
    -  : Current state is stop; press the softkey to start the pass/fail test.
    -  : Current state is running; press the softkey to stop the pass/fail test.

## To Save and Recall Test Mask

Users can save the current test mask to the internal Flash memory or external USB flash device. The file format of the test mask file is “\*.RGU”.

### ➤ Save Test Mask to Internal Memory

1. Press the **Utility** button on the front panel to enter the UTILITY function menu.
2. Press the **Next Page** softkey to go to the second page of the UTILITY function menu.
3. Press the **Pass/Fail** softkey to enter the PASS/FAIL function menu.
4. Press the **Enable Test** softkey to select **On** to enable the pass/ fail test.
5. Press the **Source** softkey to select the desired channel.
6. Press the **Mask Setting** softkey to enter the MASK function menu.
7. Press the **X Mask** or **Y Mask** softkey; and then turn the **Universal Knob** to select the desired value.
8. Press the **Location** softkey to select **Internal**
9. Press the **Save** softkey to save the mask to internal memory.
10. A few seconds later, it will pop-out the message “**Store Data Success!**”

Note: The internal memory can only save one test mask; saving a new test mask will cover the old one.

### ➤ Recall Test Mask from Internal Memory

1. Press the **Utility** button on the front panel to enter the UTILITY function menu.
2. Press the **Next Page** softkey to go to the second page of the UTILITY function menu.
3. Press the **Pass/Fail** softkey to enter the PASS/FAIL function menu.
4. Press the **Enable Test** softkey to select **On** to enable the pass/ fail test.
5. Press the **Mask Setting** softkey to enter the MASK function menu.
6. Press the **Location** softkey to select **Internal**.
7. Press the **Load** softkey to recall the saved interval memory.
8. A few seconds later, it will pop-out the message “**Read Data Success!**” and the saved mask will be displayed on the screen.

➤ **Save Test Mask to External Memory**

Do the following steps to save the test mask to external memory:

1. Press the **Utility** button on the front panel to enter the UTILITY function menu.
2. Press the **Next Page** softkey to go to the second page of the UTILITY function menu.
3. Press the **Pass/Fail** softkey to enter the PASS/FAIL function menu.
4. Press the **Enable Test** softkey to select **On** to enable the pass/ fail test.
5. Press the **Source** softkey to select the desired channel.
6. Press the **Mask Setting** softkey to enter the MASK function menu.
7. Press the **X Mask** or **Y Mask** softkey; and then turn the **Universal Knob** to select the desired value.
8. Press the **Location** softkey to select **External**
9. Press the **Save** softkey to enter the file SAVE/RECALL system.
10. Save the test mask file refer to the “**Save and Recall**” chapter.

➤ **Recall Test Mask from External Memory**

Do the following steps to save the test mask from external memory:

1. Press the **Utility** button on the front panel to enter the UTILITY function menu.
2. Press the **Next Page** softkey to go to the second page of the UTILITY function menu.
3. Press the **Pass/Fail** softkey to enter the PASS/FAIL function menu.
4. Press the **Enable Test** softkey to select **On** to enable the pass/ fail test.
5. Press the **Mask Setting** softkey to enter the MASK function menu.
6. Press the **Location** softkey to select **External**
7. Press the **Load** softkey to enter the file SAVE/RECALL system.
8. Select the desired test mask file with a RGU postfix using the **Universal Knob**; and then press the **Load** softkey.

---

## I/O Set

SDS2000X provides abundant I/O interfaces, including: USB Device, LAN and Aux Output.

### To Set the USB Device

Do the following steps to set the oscilloscope to communicate with PC via USB:

1. Install the USBTMC device driver on PC. The latest compatible version of National Instruments VISA is suggested.
2. Connect the oscilloscope with the PC using a standard USB cable
3. Press the **Utility** button on the front panel to enter the UTILITY function menu.
4. Press the **I/O Set** softkey to enter the I/O SET function menu.
5. Press the **USB Device** softkey to select **USBTMC**.
6. Use EasyScopeX or NI-MAXto communicate with the oscilloscope.

Do the following steps to set the oscilloscope to print the screen image:

1. Connect the oscilloscope with print using a standard USB cable.
2. Press the **Utility** button on the front panel to enter the UTILITY function menu.
3. Press the **I/O Set** softkey to enter the I/O SET function menu.
4. Press the **USB Device** softkey to select **Printer**.
5. Press the Print button on the front panel to print the screen image.

## To Set the LAN

Do the following steps to set the oscilloscope to communicate with PC via LAN:

1. Connect the oscilloscope to your local area network using the network cable.
2. Press the **Utility** button on the front panel to enter the UTILITY function menu.
3. Press the **I/O Set** softkey to enter the I/O SET function menu.
4. Press the **LAN** softkey to enter the LAN setting interface, see the picture below:

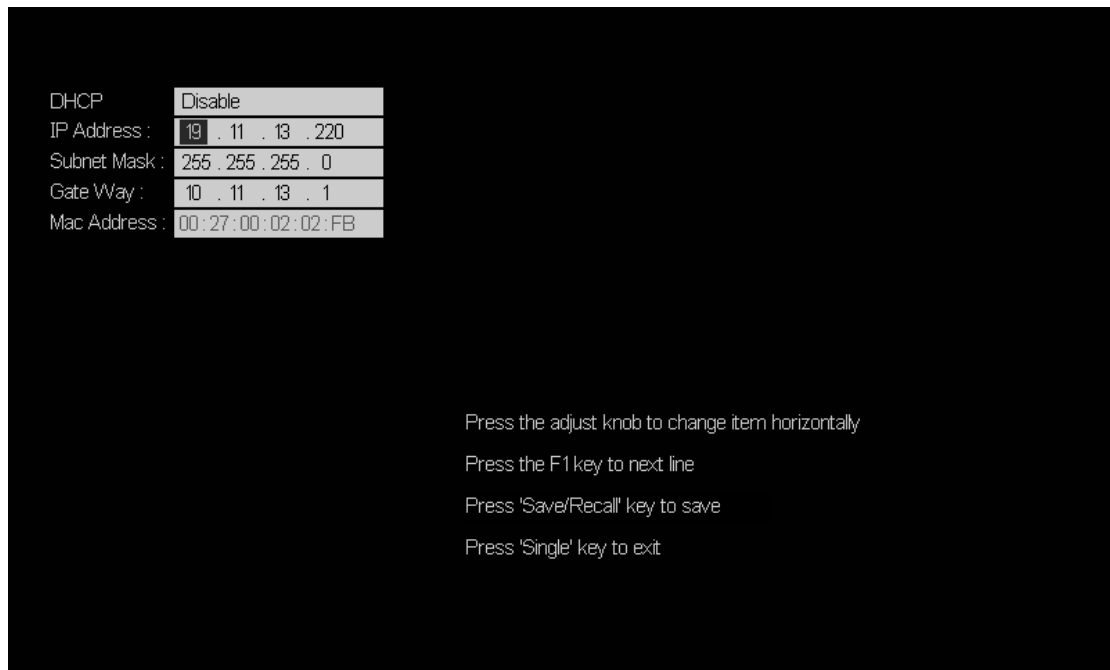

Figure 94: LAN Setting Interface

5. Press the F1 softkey (the first softkey below the screen) continually to go to the DHCP line; then turn the **Universal Knob** to select Enable or Disable.
  - **Enable:** The DHCP server in the current network will assign the network parameters (such as the IP address) for the oscilloscope.
  - **Disable:** Set the IP address, subnet mask, and gate way manually.
    - Turn the **Universal Knob** to select the desired value.
    - Push the **Universal Knob** to change item horizontally.
    - Press the **F1** softkey to go to the next line.
    - Press the **Save/Recall** softkey to save the current setting.
    - Press the **Single** button to exit the setting interface.
6. Use EasyScopeX or NI-MAX to communicate with the oscilloscope.

---

## To Set Aux Output

Users can set the type of the signal output from the **[Trigger Out]** connector at the rear panel.

1. Press the **Utility** button on the front panel to enter the UTILITY function menu.
2. Press the **I/O Set** softkey to enter the I/O SET function menu.
3. Press the Aux Output softkey to select Trig Out or Pass/Fail. The default setup is **Trig Out**.
  - **Trig Out:** If this type is selected, the oscilloscope outputs a signal that can reflect the current capture rate of the oscilloscope at each trigger. The maximal capture rate of SDS2000X is 140k wfs/s.
  - **Pass/Fail:** If this type is selected, the oscilloscope will output a pulse signal when failed waveforms are detected. This signal can be connected to other control systems to conveniently view the test results.

## To Do Power Analysis

The Power Analyze application enables quick and easy analysis on switching power supply efficiency and reliability.

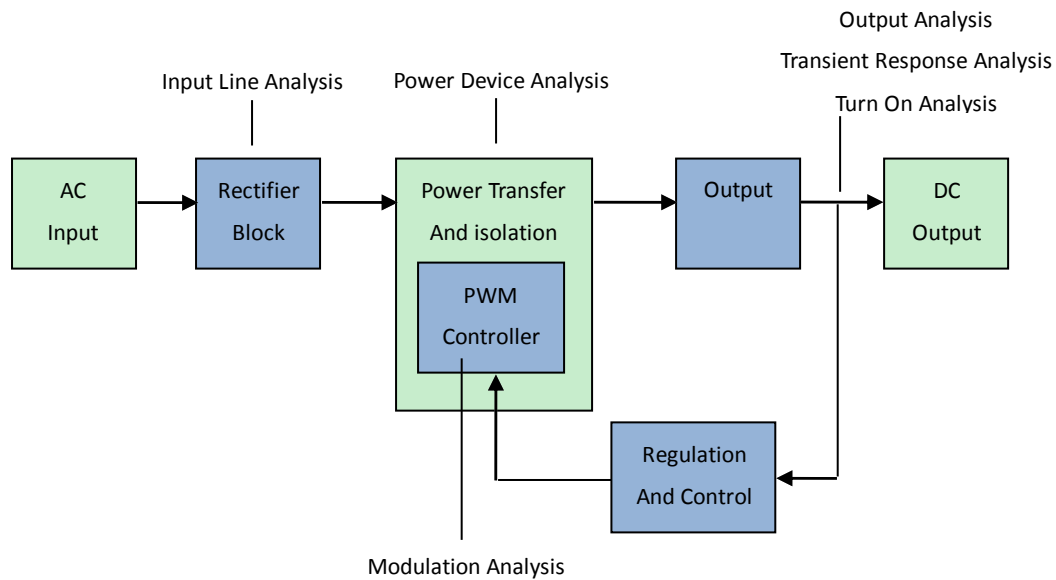

### Switch-Mode Power Supply (SMPS) Block Diagram and Types of Measurements

The Power Analyze application can facilitate:

- Measuring switching loss and conduction loss at the switching device
- Analyzing  $di/dt$  and  $dV/dt$  slew rate
- Automating the oscilloscope setup for ripple measurements
- Performing pre-compliance testing to IEC 61000-3-2 standards
- Analyzing line power with total harmonic distortion, real power, apparent power, power factor tests
- Analysis on modulation using the on-time information of a Pulse Width Modulation (PWM) signal

The Power Analyze application license, along with the oscilloscope, high-voltage differential probe, current probe, probe deskew fixture, and passive probe, form a complete power measurement system for power supply design and testing.



## To Perform Channel Deskew

To make accurate power loss measurements, current and voltage channel deskew using the DF2001A deskew fixture must be performed. The channel deskew procedure calibrates the time delay between the current and voltage probes. This step is critical. A small delay in the timing of the voltage and current traces can cause a large error in the instantaneous power reading.

The deskew accuracy is a function of the electrical characteristics of the voltage and current probes as well as the rise time of the signal-under-test. In general, higher bandwidth probes will allow better rise time fidelity and better deskew resolution.

The deskew procedure should be performed once initially, and re-run when any part of the hardware setup changes (for example, a different probe, different oscilloscope channel, etc.) or when the ambient temperature changes.

To deskew, perform the following steps:

1. First, demagnetize and zero-adjust the current probe.
2. Set up connections to the DF2001A deskew fixture:

	Small Loop	Large Loop
Available current probes	CP4020(100KHz,20Arms) CP4050 (1MHz,50Arms) CP4070 (150kHz,70Arms) CP4070A(300kHz,70Arms) CP5030 (50MHz,30Arms) CP5030A (100MHz,30Arms)	CP5150(12MHz,150Arms) CP5500 (5MHz,500Arms)
High-voltage differential probe sense points	J7: signal terminal J6: earth terminal	J3: signal terminal J4: earth terminal

- a. Connect D+ and D- of the high-voltage differential probe to the deskew fixture.
- b. Connect the current probe to the loop with the direction of the arrow indicating the direction of the current flow.
- c. Make sure the switch S1 on the deskew fixture is set to the appropriate side of the fixture (either “small loop” or “large loop”).
- d. Connect the deskew fixture to a USB port on your oscilloscope or a PC using a USB cable. The USB port supplies power to the deskew fixture.

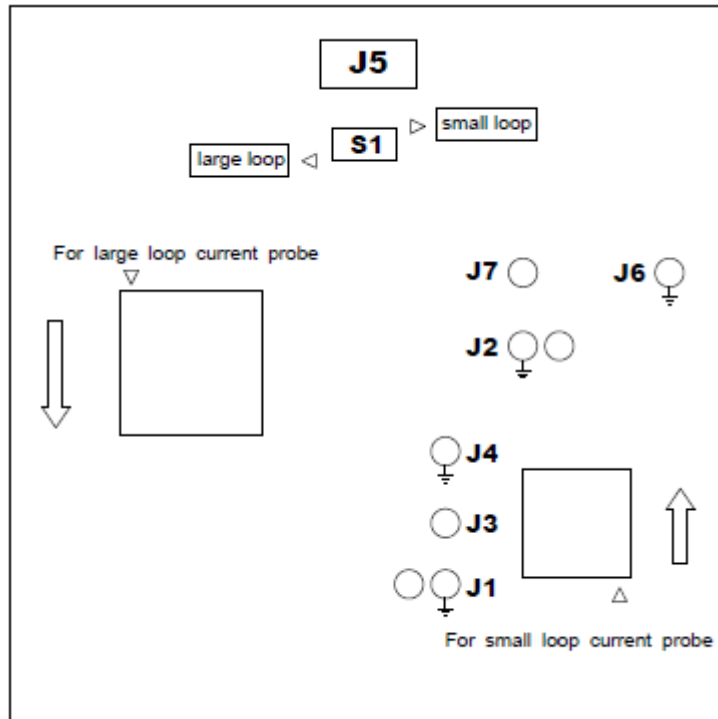

Figure 95: DF2001A Deskew Fixture

3. Press the **Utility** on the front panel to enter the UTILITY function menu.
4. Press the **Next Page** softkey to enter the second page of the UTILITY function menu.

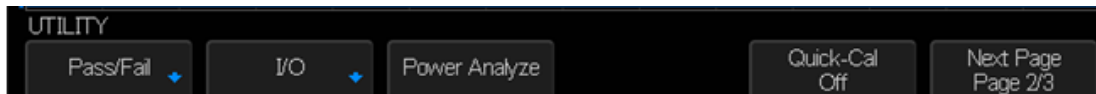

Figure 96: Second Page of the UTILITY Function Menu

5. Press the Power Analyze softkey to enter the ANALYSIS function menu.



Figure 97: UTILITY Function Menu

6. Press the Signal softkey to enter the SIGNAL setting menu.



Figure 98: Power Analysis SIGNAL Menu

7. Press the **Voltage** softkey, and then turn the universal knob to select the analog channel probing the voltage signal.
8. Press the **Current** softkey, and then turn the universal knob to select the analog channel probing the current signal.
9. Press the **Auto Deskew** softkey. When the process completes, a message indicating whether the deskew is successful will pop-up.



Figure 99: Deskew Success

## Perform Power Analysis

This chapter describes the available types of power analysis with the Power Analyze application:

- Power Quality
- Harmonics
- Inrush
- Switching
- Slew Rate
- Modulation
- Output Ripple
- Turn On/Off
- Transient
- Efficiency

## Power Quality

The Power Quality analysis shows the quality of the AC input line.

Some AC current may flow back into and back out of the load without delivering energy. This current, called reactive or harmonic current, gives rise to an “apparent” power which is larger than the actual power consume. Power quality is determined by the following measurements RMS voltage, RMS current, Apparent Power, Real Power, etc.

1. Press the **Utility** button on the front panel to enter the UTILITY function menu.
2. Press the **Next Page** softkey to enter the second page of the UTILITY function menu.
3. Press the **Power Analyze** softkey to enter the ANALYSIS function menu.
4. Press the **Analysis** softkey, and then turn the universal knob to select **Power Quality** and press down the knob to confirm.



Figure 100: ANALYSIS Function Menu

5. Connect the appropriate probes to the device to be tested and to the oscilloscope
  - a. Select the proper attenuation ratio for the probes.
  - b. Connect D+ of the voltage probe to the live wire of the AC input.
  - c. Connect D- of the voltage probe to the neutral wire of the AC input.
  - d. Connect the current probe to the live wire of the AC input with the direction of the arrow pointing towards the current flow.
  - e. Connect the voltage and current probes to the desired oscilloscope channels.
6. Press the **Signal** softkey to enter the SIGNAL menu.



Figure 101: Power Quality SIGNAL Menu

7. Press the **Voltage** and **Current** softkeys and then turn the universal knob to select the channels..
8. Make sure the proper probe attenuation factors are set in the oscilloscope channels.
9. Press the **Cycles** softkey, and then turn the universal knob in order to set the number of cycles on the screen's display.
10. Press the **Auto Setup** softkey to automatically set the appropriate time/div and volt/div for the measurement.
11. Return to the ANALYSIS function menu.
12. Press the **Type** softkey, and then turn the universal knob to select the type of measurement:
  - **V<sub>rms</sub>**: Root mean square of the AC line voltage.
  - **I<sub>rms</sub>**: Root mean square of the AC line current.

- **Real Power:** The portion of power flow averaged over a complete cycle of the AC waveform, the result is the net transfer of energy in one direction.
- **Apparent Power:** The portion of power flow due to stored energy, which returns to the source in each cycle.
- **Reactive Power:** The difference between apparent power and real power due to reactance.
- **Voltage Crest Factor:** The ratio between the instantaneous peak voltage required by the load and the RMS voltage.
- **Current Crest Factor:** The ratio between the instantaneous peak current required by the load and the RMS current.
- **Phase Angle:** In the power triangle (where  $\text{apparent\_power}^2 = \text{real\_power}^2 + \text{reactive\_power}^2$ ), phase angle is the angle between the apparent power and the real power, indicating the amount of reactive power.

13. Press the **Apply** softkey to perform analysis to perform power quality analysis.



Figure 102: Perform Power Quality Analysis

The voltage and current waveforms are displayed as well as the input power waveform (waveform math multiply of the voltage and current). Also displayed are the power quality measurements you have selected and applied. There are at most 4 measurements displayed at a time.

14. Press the **Statistics** softkey to select **On** or **Off** to turn on or turn off the statistics function.

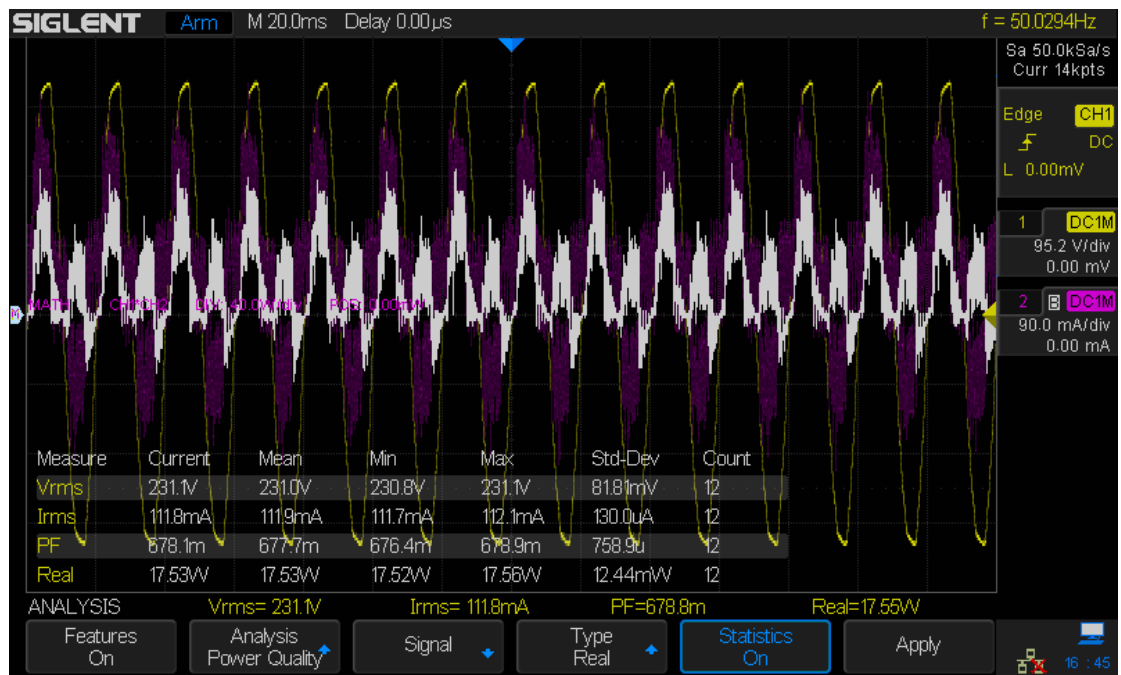

Figure 103: Turn on Statistic Function

## Current Harmonics

Switching power supplies draw a range of harmonics from the AC mains. Standard limits are set for the power of the harmonics that travel back to the power distribution grid. These reflected harmonics can cause problems with other devices on the grid.

Use the current harmonics analysis to perform the pre-compliance test of IEC61000-3-2 (Class A, B, C (no support) or D) standard. The analysis presents up to 40 harmonics for a given input signal.

1. Press the **Utility** button on the front panel to enter the UTILITY function menu.
2. Press the **Next Page** softkey to enter the second page of the UTILITY function menu.
3. Press the **Power Analyze** softkey to enter the ANALYSIS function menu.
4. Press the **Analysis** softkey, and then turn the universal knob to select **Harmonics** and press down the knob to confirm.



Figure 104: ANALYSIS Function Menu

5. Connect probes to the device-under-test and to the oscilloscope as well.
  - a. Connect the current probe to the live wire of the AC input with the direction of the arrow pointing towards the current flow.
  - b. Connect the voltage and current probes to the desired oscilloscope channels.
6. Press the **Signal** softkey to enter the SIGNAL menu.



Figure 105: Harmonics SIGNAL Menu

7. Press the **Voltage** and **Current** softkeys and then turn the universal knob to select the channels.
8. Press the **Cycles** softkey, and then turn the universal knob in order to set the number of cycles on the screen's display.
9. Press the **Auto Setup** softkey to automatically set the appropriate time/div and volt/div for the measurement.
10. Press the return button to return to the ANALYSIS function menu.
11. Press the **Settings** softkey to enter the SETTINGS menu.



Figure 106: Harmonics SETTING Menu

12. Press the **Line Freq** softkey, and then turn the universal knob to select the appropriate line frequency 50Hz, 60Hz or 400Hz.

13. Press the **Standard** softkey, and then turn the universal knob to select the desired standard to perform compliance testing on the current harmonics.

- IEC 6100-3-2 Class A – for balanced three- phase equipment, household appliances (except equipment identified as Class D), tools excluding portable tools, dimmers for incandescent lamps, and audio equipment.
- IEC 6100-3-2 Class B – for portable tools.
- IEC 6100-3-2 Class C (no support) – for lighting equipment.
- IEC 6100-3-2 Class D – for equipment having a specified power according less than or equal to 600W, of the following types: personal computers and personal computer monitors, television receivers.

14. Return to the ANALYSIS function menu.

15. Press the **Apply** softkey to perform the harmonics analysis. When the analysis has completed, results are displayed.

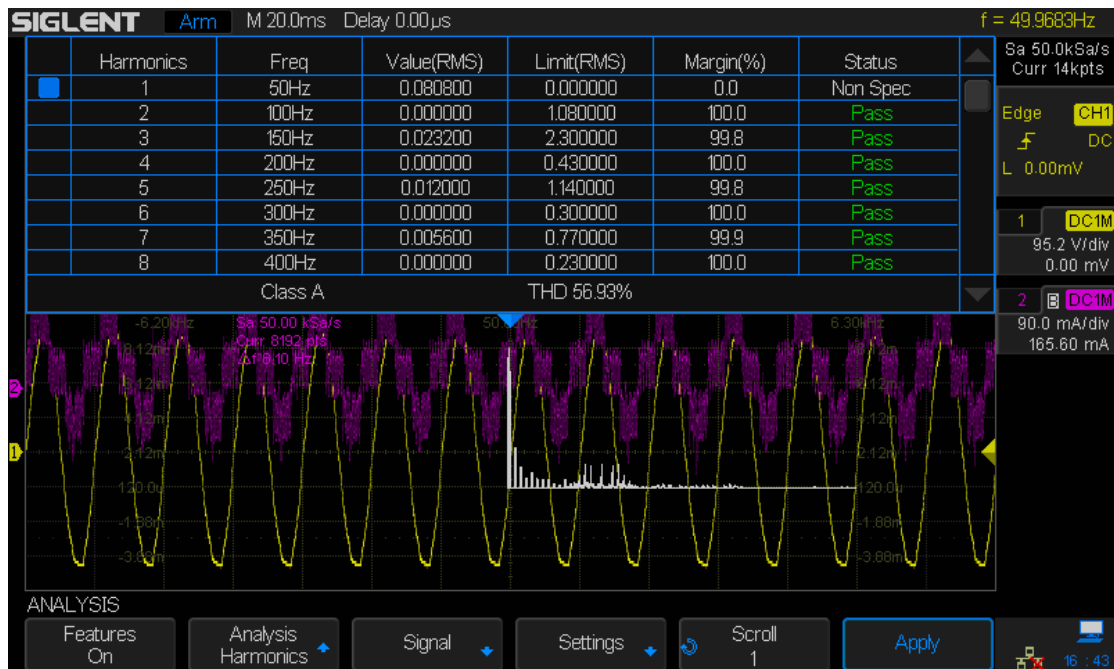

Figure 107: Harmonics Analysis

FFT waveform	Shows the frequency components in the input current. The FFT is calculated using the Hanning window.
Harmonic, Value (RMS), Limit(RMS), Margin, Status	<p>For the first 40 harmonics, these values are displayed:</p> <ul style="list-style-type: none"> <li>● Value (RMS): the measured value in the units specified by the Harmonics Unit parameter.</li> <li>● Limit (RMS): the limit specified by the selected Current Harmonics Standard.</li> <li>● Margin: the margin between the measured value and the limit.</li> <li>● Status: Non Spec, Pass, Fail</li> </ul>



	<p>Non Spec: the Limit (RMS) is 0</p> <p>Pass: Margin is greater than 80% of the limit but less than 100% of the limit.</p> <p>Fail: Margin is less than 80%</p>
THD (Total Harmonics Distortion)	$\text{THD} = \frac{\sqrt{X_2^2 + X_3^2 + X_4^2 + \dots + X_n^2}}{X_1} \times 100\%$ <p>Where :</p> <p><math>X_n</math> = voltage or current of each harmonic</p> <p><math>X_1</math> = fundamental voltage or current value</p>

## Inrush

The inrush current analysis measures the peak inrush current when the power supply is first turned on.

1. Press the **Utility** button on the front panel to enter the UTILITY function menu.
2. Press the **Next Page** softkey to enter the second page of the UTILITY function menu.
3. Press the **Power Analyze** softkey to enter the ANALYSIS function menu.
4. Press the **Analysis** softkey, and then turn the universal knob to select **Inrush** and press down the knob to confirm.



Figure 108: ANALYSIS Function Menu

5. Connect probes to the device-under-test and to the oscilloscope as well.
6. Select the proper attenuation ratio for the probes.
  - a. Connect D+ of the voltage probe to the live wire of the AC input.
  - b. Connect D- of the voltage probe to the neutral wire of the AC input.
  - c. Connect the current probe to the live wire of the AC input with the direction of the arrow pointing towards the current flow.
  - d. Connect the voltage and current probes to the desired oscilloscope channels.
7. Press the **Signal** softkey to enter the SIGNAL menu.



Figure 109: Inrush Analysis SIGNAL Menu

8. Press the **Voltage** and **Current** softkeys and then turn the universal knob to select the channels.
9. Make sure the proper probe attenuation factors are set in the oscilloscope for the voltage and current probes.
10. Press the **Expected** softkey, and then turn the universal knob to specify the expected inrush current amplitude. This sets the vertical scale of the channel probing current.
11. Press the **Max Vin** softkey, and then turn the universal knob to specify the maximum input voltage. This sets the vertical scale of the channel probing voltage.
12. Return to the ANALYSIS function menu.
13. Press the **Apply** softkey to perform the analysis. Follow the onscreen instructions showing as below:
  - a. Turn off the power supply, then press Next.
  - b. Turn on the power supply, then press Next.

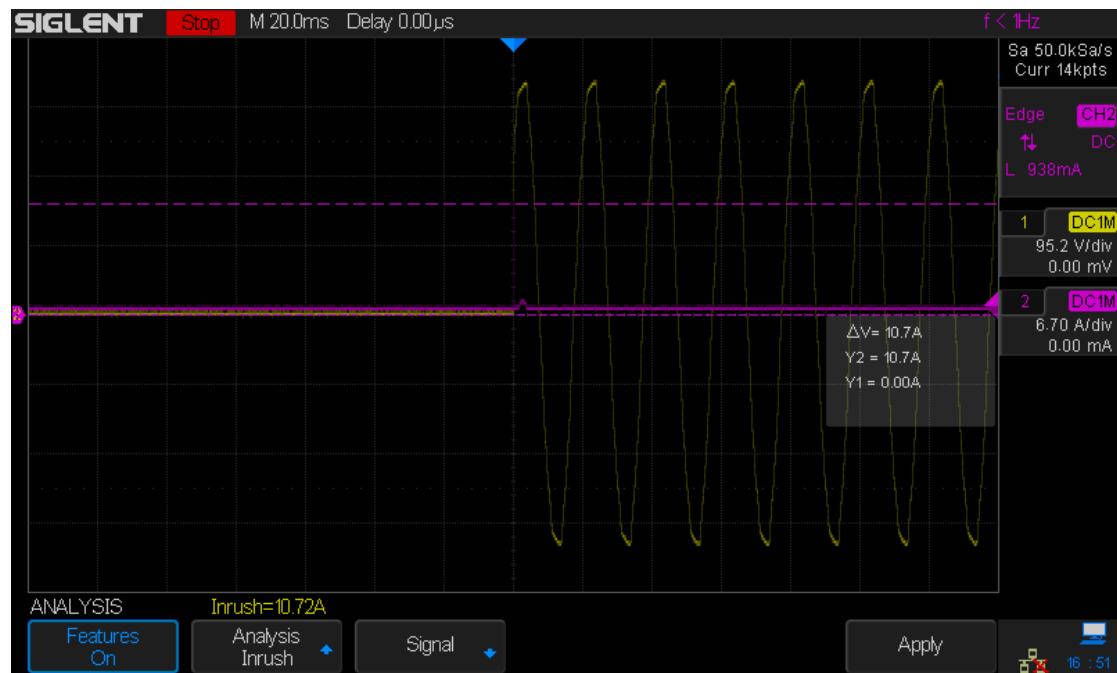

Figure 110: Inrush Analysis

When the analysis has completed, results are displayed at the bottom of the screen.

- **Peak Current:** the peak current can be a positive or negative value, so the result is larger one of the measured maximum or minimum values.  
The peak current measurement is made on the source input.

## Switching

The switching loss analysis calculates the power dissipated in one switching cycle across the switching device. Typical power losses include:

- Switching loss that occur during switching of  $V_{ds}$  and  $I_d$ .
- Conduction losses that occur when the switching device (MOSFET) is ON.

Design engineers use this information to evaluate the power conversion efficiency of the power supply.

Switching loss is also used to quantify the power loss that is transferred to the heat sink of the power device.

1. Press the **Utility** button on the front panel to enter the UTILITY function menu.
2. Press the **Next Page** softkey to enter the second page of the UTILITY function menu.
3. Press the **Power Analyze** softkey to enter the ANALYSIS function menu.
4. Press the **Analysis** softkey, and then turn the universal knob to select **Switching** and press down the knob to confirm.



Figure 111: ANALYSIS Function Menu

5. Connect the probes to the device-under-test and to the oscilloscope as well.
  - a. Select the proper attenuation ratio for the probes.
  - b. Connect D+ of the voltage probe to the source of the MOSFET or the transistor's emitter.
  - c. Connect D- of the voltage probe to the drain of the MOSFET or the transistor's collector.
  - d. Connect the current probe to the I drain of the MOSFET with the direction of the arrow pointing towards the current flow.
  - e. Connect the voltage and current probes to the desired oscilloscope input channels.
6. Press the **Signal** softkey to enter the SIGNAL menu.



Figure 112: Switching Analysis Signal Menu

7. Press the **Voltage** and **Current** softkeys and then turn the universal knob to select the channels
8. Make sure the proper probe attenuation factors are set in the oscilloscope for the voltage and current probes.
9. Press the **Auto Setup** softkey to automatically set the appropriate time/div and volt/div

for the measurement.

10. Return to the ANALYSIS function menu.

11. Press the **Settings** softkey to enter the SETTINGS menu.



Figure 113: Switching Analysis SETTINGS Menu

12. Press the **V Ref** softkey, and then turn the universal knob to select the desired value.

- Enter the switching level for the switching edges. The displayed value is the percentage of the maximum switching voltage.

You can adjust this value to ignore the noise floor.

This value specifies the threshold that is used to determine the switching edges.

13. Press the **I Ref** softkey, and then turn the universal knob to select the desired value.

- Enter the switching level for the start of switching edges. The displayed value is the percentage of the maximum switch current.

You can adjust this value to ignore the noise floor or null offset that is difficult to eliminate in current probes.

This value specifies the threshold that is used to determine the switching edges.

14. Press the **Conduction** softkey, and then turn the universal knob to select the conduction calculation.

- Volt Waveform: The power waveform uses the original data, and the calculation is :  $P = V \times I$
- Rds (on): The power waveform includes error correction:
  - In the “on” zone (where the voltage level is below V Ref), the power calculation is:  $P = I_{d^2} \times R_{ds} (on)$   
Specify **Rds (on)** using the additional softkey.
  - In the “off” zone (where the current level is below I Ref), the power calculation is:  $P = 0$  Watt.
- Vce (sat): The power waveform includes error correction:
  - In the “on” zone (where the voltage level is below V Ref), the power calculation is:  $P = V_{ce} (sat) \times I_c$   
Specify **Vce (sat)** using the additional softkey.
  - In the “off” zone (where the current level is below I Ref), the power calculation is:  $P = 0$  Watt.

15. Return to the ANALYSIS function menu.

16. Press the **Apply** softkey to perform the analysis. When the analysis has completed, results are displayed. (The following figure is an LLC topology circuit test results)

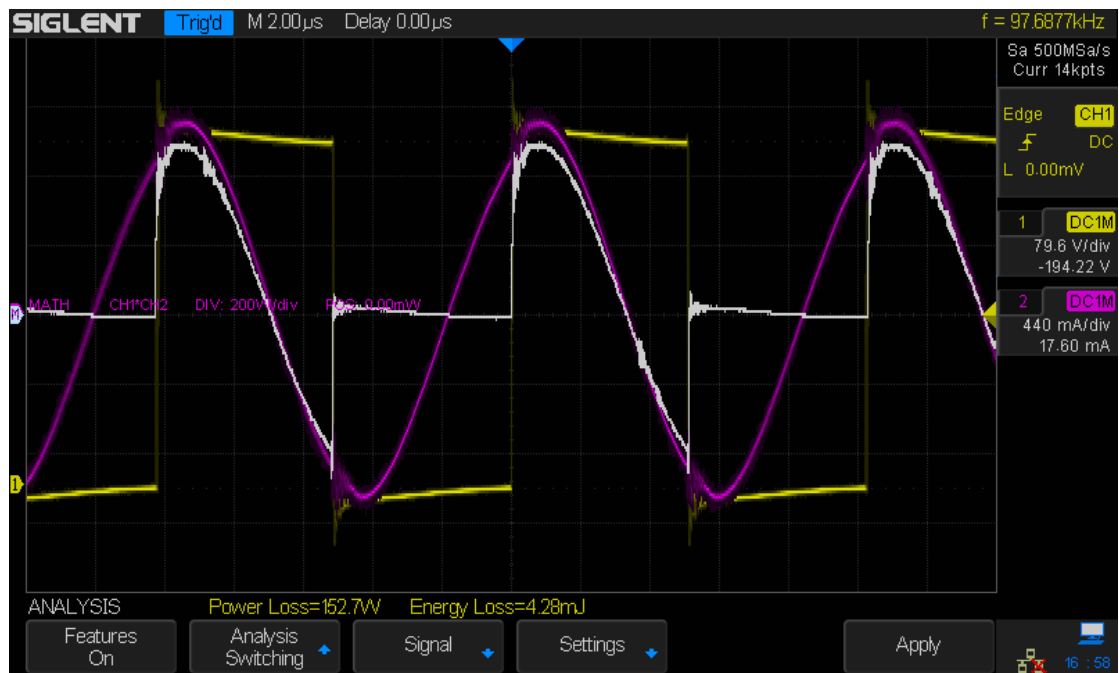

Figure 114: Switching Analysis

The voltage and current waveforms are displayed, as well as the power waveform (waveform math multiply of the voltage and current). Also displayed are the Power Loss and Energy Loss measurements.

- **Power Loss:**  $P_n = V_{ds_n} * I_{d_n}$ , where n is in each sample. The power loss measurement is made on one source input that represents power. This is typically the multiplication of the voltage and current waveforms.
- **Energy Loss:**  $E_n = \sum (V_{ds_n} * I_{d_n}) * \text{time}$ , where n is in each sample. The energy loss measurement is made on one source input that represents power. This is typically the multiplication of the voltage and current waveforms.

## Slew Rate

The slew rate analysis measures the rate of the voltage or current change during switching.

1. Press the **Utility** button on the front panel to enter the UTILITY function menu.
2. Press the **Next Page** softkey to enter the second page of the UTILITY function menu.
3. Press the **Power Analyze** softkey to enter the ANALYSIS function menu.
4. Press the **Analysis** softkey, and then turn the universal knob to select **Slew Rate** and press down the knob to confirm.

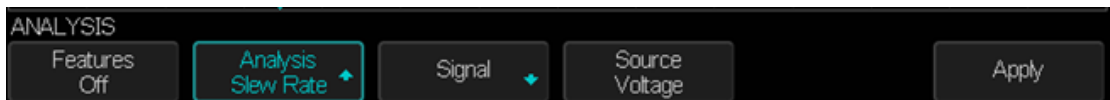

Figure 115: Slew Rate ANALYSIS Function Menu

5. Connect the probes to the device-under-test and to the oscilloscope as well.
  - a. Select the proper attenuation ratio for the probes.
  - b. Connect D+ of the voltage probe to the source of the MOSFET.
  - c. Connect D- of the voltage probe to the drain of the MOSFET.
  - d. Connect the current probe to the drain of the MOSFET with the direction of the arrow pointing towards the current flow.
  - e. Connect the voltage and current probes to the desired oscilloscope input channels.
6. Press the **Signal** softkey to enter the SIGNAL menu.



Figure 116: Slew Rate Signal Menu

7. Press the **Voltage** and **Current** softkeys and then turn the universal knob to select the channels.
8. Make sure the proper probe attenuation factors are set in the oscilloscope for the voltage and current probes.
9. Press the **Auto Setup** softkey to automatically set the appropriate time/div and volt/div for the measurement.
10. Return to the ANALYSIS function menu.
11. Press the **Source** softkey to select either Voltage or Current as the source for the slew rate analysis.
12. Press the **Apply** softkey to perform the analysis. When the analysis has completed, results are displayed.

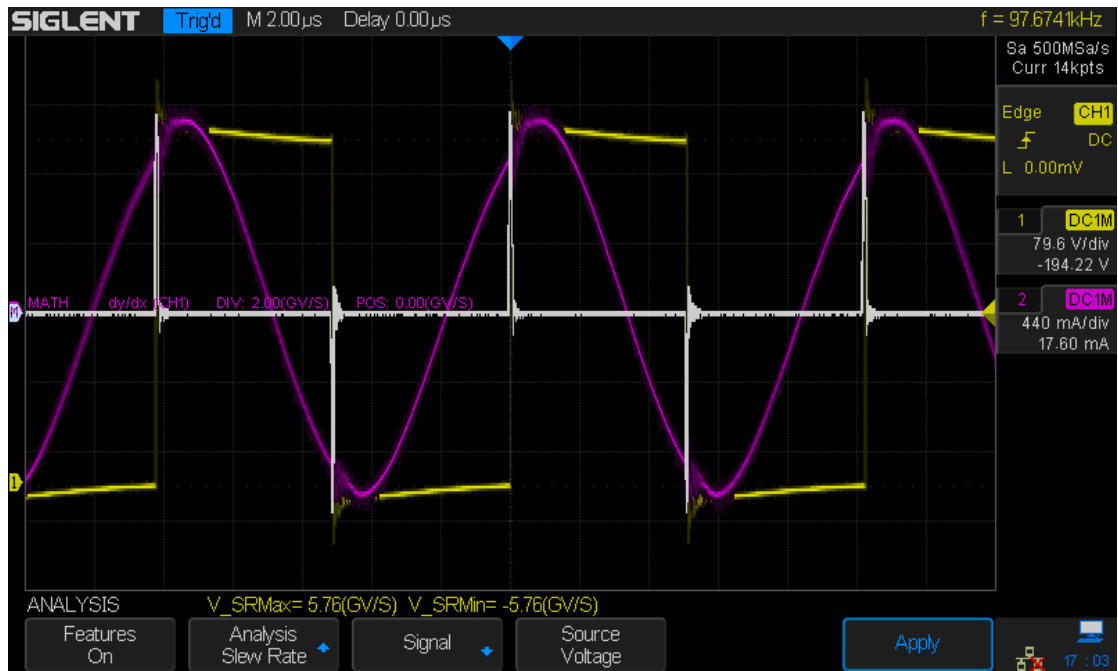

Figure 117: Perform Slew Rate Analysis

The voltage (Purple) and current waveform (Yellow) are displayed along with a differentiated math function waveform that shows the slew rate (White).

Max and Min measurements on the slew rate waveform are added and displayed.

- Voltage slew rate:  $dV/dt = [V_{(n)} - V_{(n-1)}] / [t_{(n)} - t_{(n-1)}]$ , measures the slew rate of Vds of the power device (MOSFET).
- Current slew rate:  $dI/dt = [I_{(n)} - I_{(n-1)}] / [t_{(n)} - t_{(n-1)}]$ , measures the slew rate of Id of the power device (MOSFET).



## Modulation

The modulation analysis measures the control pulse signal to a switching device (MOSFET) and observes the trending of the average, RMS-AC, period, frequency, positive width, negative width, duty cycle, rise time and fall time of the control pulse signal in response to different events.

1. Press the **Utility** button on the front panel to enter the UTILITY function menu.
2. Press the **Next Page** softkey to enter the second page of the UTILITY function menu.
3. Press the **Power Analyze** softkey to enter the ANALYSIS function menu.
4. Press the **Analysis** softkey, and then turn the universal knob to select **Modulation** and press down the knob to confirm.



Figure 118: Modulation ANALYSIS Function Menu

5. Connect the probes to the device-under-test and to the oscilloscope as well.
  - a. Select the proper attenuation ratio for the probes.
  - b. Connect D+ of the voltage probe to the gate of the MOSFET.
  - c. Connect D- of the voltage probe to the source of the MOSFET.
  - d. Connect the current probe to the I drain of the MOSFET with the direction of the arrow pointing towards the current flow.
  - e. Connect the voltage and current probes to the desired oscilloscope input channels.
6. Press the **Signal** softkey to enter the SIGNAL menu.



Figure 119: Modulation SIGNAL Menu

7. Press the **Voltage** and **Current** softkeys and then turn the universal knob to select the channels.
8. Make sure the proper probe attenuation factors are set in the oscilloscope for the voltage and current probes.
9. Press the **Duration** softkey, and then turn the universal knob to set the time duration to capture signals. This sets the time/div of the oscilloscope.
10. Press the **Auto Setup** softkey to automatically set the appropriate time/div and volt/div for the measurement.
11. Adjust the trigger level to capture waveforms at the same place in each cycle (in other words, stabilize the waveform display).
12. Return to the ANALYSIS function menu.
13. Press the **Source** softkey to select either **Voltage** or **Current** as the source for the

modulation analysis.

14. Press the **Type** softkey, and then turn the universal Knob to select the type of measurement to make in the modulation analysis.
  - Average
  - RMS –AC
  - Period
  - Frequency
  - Pos Width
  - Neg Width
  - Duty Width
  - Rise Time
  - Fall Time
15. Press the **Apply** softkey to perform the analysis. When the analysis has completed, the results are displayed along the bottom of the display. There are at most 4 sets of measurements displayed at the same time.



Figure 120: Modulation Analysis

The measurement trend math waveform visualization is used to plot the measurement variation for each cycle of the modulation waveforms.

## Output Ripple

The output ripple analysis measures the ripple noise of the power supply output.

1. Press the **Utility** button on the front panel to enter the UTILITY function menu.
2. Press the **Next Page** softkey to enter the second page of the UTILITY function menu.
3. Press the **Power Analyze** softkey to enter the ANALYSIS function menu.
4. Press the **Analysis** softkey, and then turn the universal knob to select **Output Ripple** and press down the knob to confirm.



Figure 121: Output Ripple ANALYSIS Function Menu

5. Connect the probes to the device-under-test and to the oscilloscope as well.
  - a. Connect the voltage probe (passive or differential) to the DC output of the power supply.
  - b. Connect the voltage probe to an oscilloscope input channel.
6. Press the **Signal** softkey to enter the SIGNAL menu.



Figure 122: Output Ripple SIGNAL Menu

7. Press the **Voltage** softkey and then turn the universal knob to select the channels.
8. Make sure the proper probe attenuation factor is set in the oscilloscope for the voltage probe.
9. Press the **Duration** softkey, and then turn the universal knob to set the time duration to capture signals. This sets the time/div of the oscilloscope.
10. Press the **Auto Setup** softkey to automatically set the appropriate time/div and volt/div for the measurement.
11. Adjust the trigger level to capture waveforms at the same place in each cycle (in other words, stabilize the waveform display).
12. Return to the ANALYSIS function menu.
13. Press the **Apply** softkey to perform the analysis. When the analysis has completed, results are displayed.

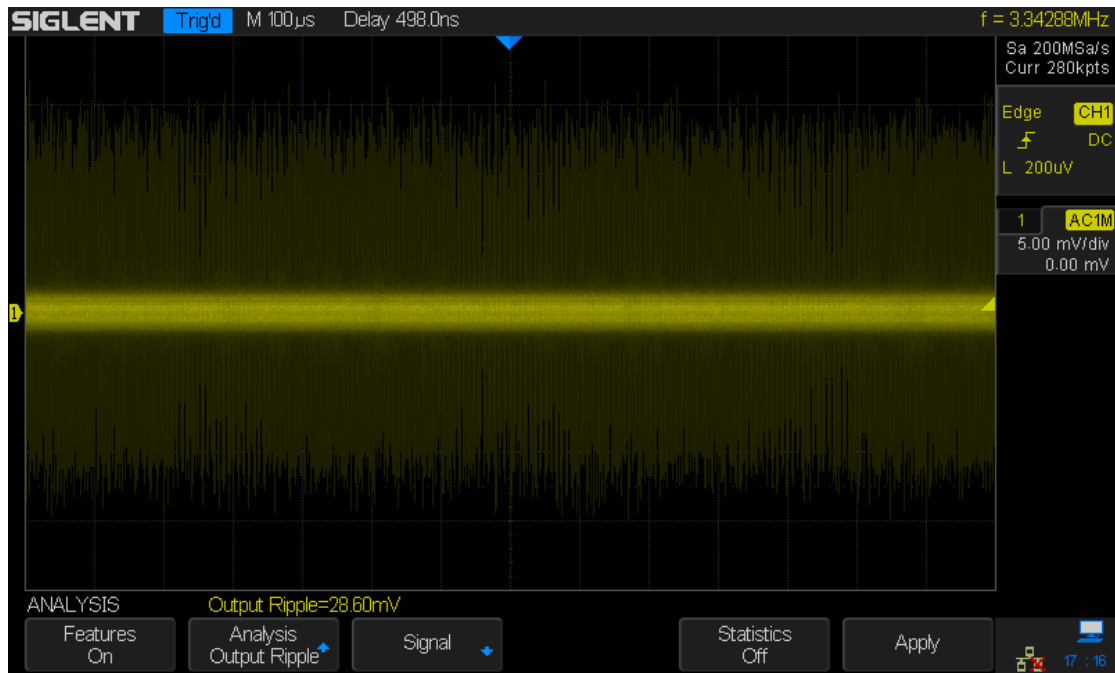

Figure 123: Perform Output Ripple Analysis

The output voltage waveform is displayed along with this automatic power measurement: Output Ripple:  $V_{Max} - V_{Min}$ . The output ripple measurement is made on one source input that is the output voltage waveform.

14. Press the **Statistics** softkey to turn on or off the statistic function.

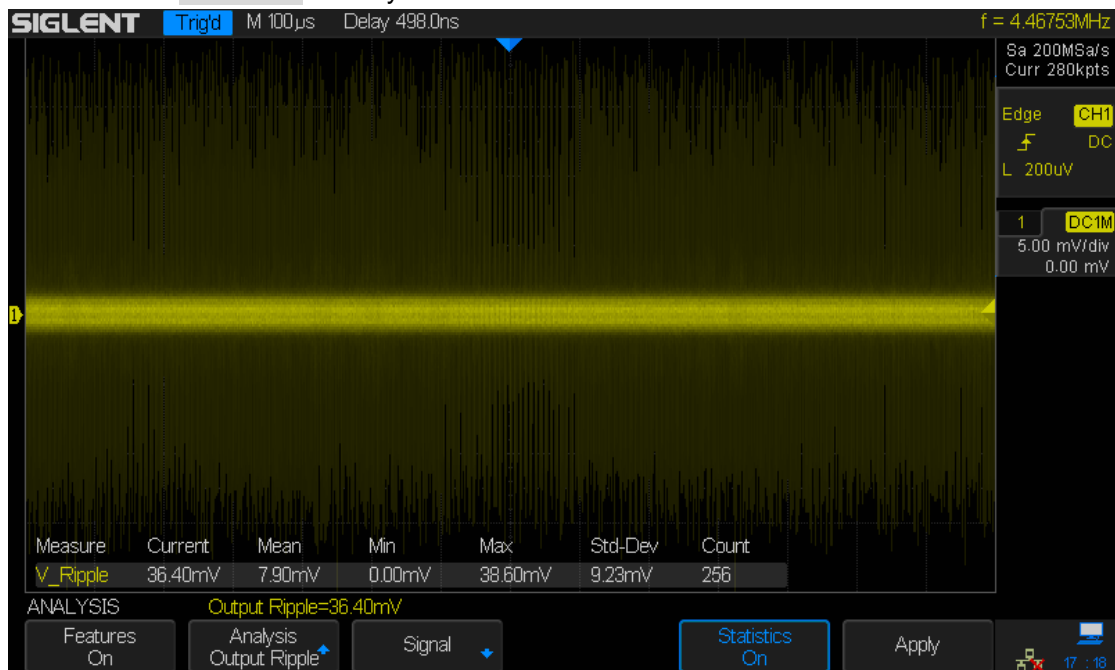

Figure 124: Turn on Statistic Function

## Turn On/ Off

The turn on analysis measures the delay from when the power supply is turned on to when its output reaches 90% of its steady state.

The turn off analysis measures the delay from when the power supply is turned off to when its output falls to 10% of its steady state.

1. Press the **Utility** button on the front panel to enter the UTILITY function menu.
2. Press the **Next Page** softkey to enter the second page of the UTILITY function menu.
3. Press the **Power Analyze** softkey to enter the ANALYSIS function menu.
4. Press the **Analysis** softkey, and then turn the universal knob to select **Turn On/Off** and press down the knob to confirm.



Figure 125: Turn On/Off ANALYSIS Function Menu

5. Connect the probes to the device-under-test and to the oscilloscope as well.
  - a. Select the proper attenuation ratio for the probes.
  - b. Connect D+ of the voltage probe to the live wire of the AC input.
  - c. Connect D- of the voltage probe to the neutral wire of the AC input.
  - d. Connect the output voltage probe (passive or differential) to the DC output of the power supply.
  - e. Connect the voltage probes to the desired oscilloscope channels.
6. Press the **Signal** softkey to enter the SIGNAL menu.



Figure 126: Turn On/Off SIGNAL Menu

7. Press the **Voltage** and **Current** softkeys and then turn the universal knob to select the channels.
8. Make sure the proper probe attenuation factors are set in the oscilloscope for the voltage and current probes.
9. Press the **Duration** softkey, and then turn the universal knob to set the time duration to capture signals. This sets the time/div of the oscilloscope.
10. Press the **Max Vin** softkey, and then turn the universal knob to specify the maximum input voltage.
 

Enter the maximum (peak to peak) source voltage amplitude. The source voltage will be used to trigger the oscilloscope in “Turn On Time” test.

This value is used to adjust the vertical scale of the channel probing the oscilloscope input voltage.
11. Press the **Steady Vout** softkey, and then turn the universal knob to specify the expected steady state output DC voltage of the power supply.

This value is used to adjust the vertical scale of the channel probing the oscilloscope output voltage.

12. Return to the ANALYSIS function menu.
13. Press the **Test** softkey to select whether turn on or turn off analysis is performed:
  - **Turn On:** Measure the time taken to get the output voltage of the power supply after the input voltage is applied.
  - **Turn Off:** Measure the time taken for the output voltage of the power supply to turn off after the input voltage is removed.
14. Press the **Apply** softkey to perform turn on/off analysis.
 

Follow the instruction on screen. When the analysis has completed, results are displayed.



Figure 127: Turn On/Off Analysis

The input and output voltage waveforms are displayed.

- Turn On Time =  $t_2 - t_1$ , where:
  - $t_1$  = AC input voltage rise to 10% of its maximum amplitude (Start Time).
  - $t_2$  = DC output voltage rise to 90% of its steady level (End Time).
- Turn Off Time =  $t_2 - t_1$ , where:
  - $t_1$  = AC input voltage goes below 10% of its positive peak (or negative peak whichever occurs first) (start time).
  - $t_2$  = DC output voltage drops to 10% of its steady level (End Time).

## Transient

The transient response analysis measures how fast the output of a power supply responds to the change at the output load. This time is from when the output voltage first exits the setting band to when it last enters the setting band.

1. Press the **Utility** button on the front panel to enter the UTILITY function menu.
2. Press the **Next Page** softkey to enter the second page of the UTILITY function menu.
3. Press the **Power Analyze** softkey to enter the ANALYSIS function menu.
4. Press the **Analysis** softkey, and then turn the universal knob to select **Transient** and press down the knob to confirm.



Figure 128: Transient ANALYSIS Function Menu

5. Connect the probes to the device-under-test and to the oscilloscope as well.
  - a. Select the proper attenuation ratio for the probes.
  - b. Connect the voltage probe (passive or differential) to the DC output of the power supply.
  - c. Connect the voltage probe to an oscilloscope input channel.
  - d. Connect the current probe to the output load of the power supply.  
The change in the load current will be used to trigger the oscilloscope to capture the transients.
  - e. Connect the current probe to an oscilloscope input channel.
6. Press the **Signal** softkey to enter the SIGNAL menu.



Figure 129: Transient SIGNAL Menu

7. Press the **Voltage** and **Current** softkeys and then turn the universal knob to select the channels.
8. Make sure the proper probe attenuation factors are set in the oscilloscope for the voltage and current probes.
9. Press the **Duration** softkey, and then turn the universal knob to set the time duration to capture signals. This sets the time/div of the oscilloscope.
10. Press the **Over Shoot** softkey, and then turn the universal knob to specify the % of overshoot of the output voltage.  
This value is used to determine the setting band value for the transient response and adjust the vertical scale of the oscilloscope.
11. Press the **Steady Vout** softkey, and then turn the universal knob to specify the expected steady state output DC voltage of the power supply.  
This value is used to along with the overshoot percentage specify the setting band for the transient response and to adjust the vertical scale of the oscilloscope.
12. Return to the ANALYSIS function menu.

13. Press the **Settings** softkey to enter the SETTINGS menu.



Figure 130: Transient SETTING Menu

14. Press the **Initial I** softkey, and then turn the universal knob to specify the initial load current value. The initial load current will be used as a reference and to trigger the oscilloscope.

15. Press the **New I** softkey, and then turn the universal knob to specify the new load current value. The new load current will be used as a reference and to trigger the oscilloscope.

16. Return to the ANALYSIS function menu.

17. Press the **Apply** softkey to perform turn on/off analysis.

Follow the instruction on screen. When the analysis has completed, results are displayed along the bottom of the display.

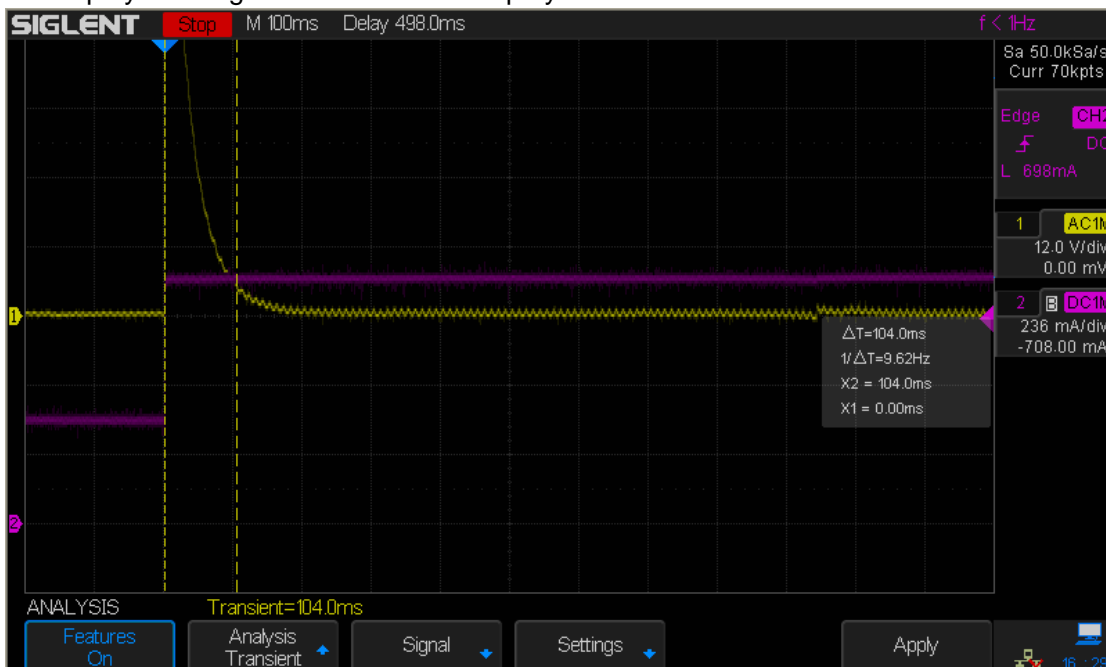

Figure 131: Transient Analysis

Transient response time =  $t_2 - t_1$ , where:

- $t_1$  = The first time a voltage waveform exits the setting band.
- $t_2$  = The last time it enters into the setting band.
- Setting band = +/- overshoot% of the steady state output voltage.



## Efficiency

Efficiency analysis tests the overall efficiency of the power supply by measuring the output power and the input power. A 4-channel model SDS2000X oscilloscope is necessary to apply the efficiency analysis.

1. Press the **Utility** button on the front panel to enter the UTILITY function menu.
2. Press the **Next Page** softkey to enter the second page of the UTILITY function menu.
3. Press the **Power Analyze** softkey to enter the ANALYSIS function menu.
4. Press the **Analysis** softkey, and then turn the universal knob to select **Efficiency** and press down the knob to confirm.



Figure 132: Efficiency ANALYSIS Function Menu

5. Connect the probes to the device-under-test and to the oscilloscope as well.
  - a. Select the proper attenuation ratio for the probes.
  - b. Connect D+ of the input voltage probe to the live wire of the AC input.
  - c. Connect D- of the input voltage probe to the neutral wire of the AC input.
  - d. Connect the input current probe to the live wire of the AC input with the direction of the arrow pointing towards the current flow.
  - e. Connect D+ of the output voltage probe to the input path of the load.
  - f. Connect D- of the output voltage probe to the return path of the load.
  - g. Connect the output current probe to the input path of the load with the direction of the arrow pointing towards to the current flow.
  - h. Connect the voltage and current probes to the desired oscilloscope channels.
6. Press the **Signal** softkey to enter the SIGNAL menu.

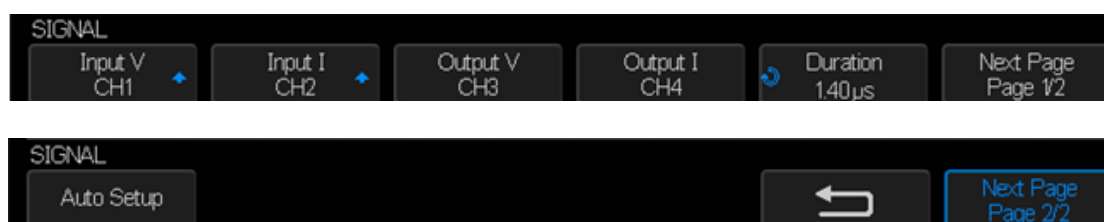

Figure 133: Efficiency SIGNAL Menu

7. Press the **Input V**, **Input I**, **Output V** and **Output I** softkeys and then turn the universal knob to select the channels.
8. Make sure the proper probe attenuation factors are set in the oscilloscope for the voltage and current probes.
9. Press the **Duration** softkey, and then turn the universal knob to set the time duration to capture signals. This sets the time/div of the oscilloscope.
10. Press the **Auto Setup** softkey to automatically set the appropriate time/div and volt/div for the measurement.
11. Return to the ANALYSIS function menu.

12. Press the **Apply** softkey to perform the efficiency analysis. When the analysis has completed, the results are displayed as shown below.

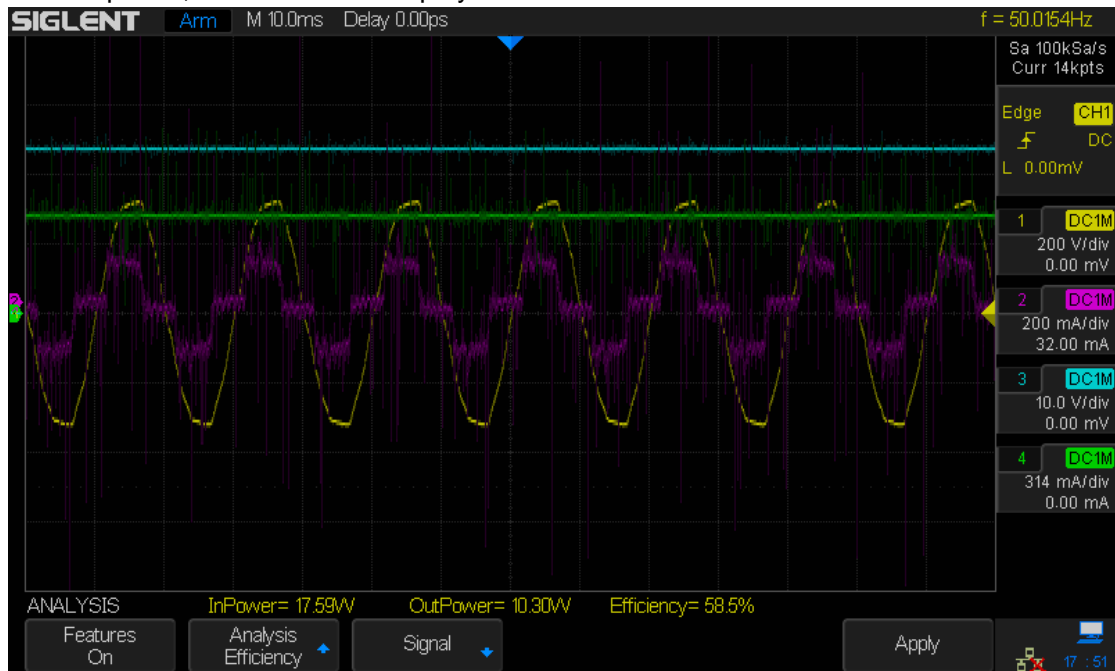

Figure 134: Perform Efficiency Analysis

The input voltage, input current waveforms, output voltage and output current waveforms are displayed, as well as the calculated input power, output power and efficiency:

- Input Power = Input V \* Input I
- Output Power = Output V \* Output I
- Efficiency = Input Power / Output Power

---

## To Enable Quick-Cal

Quick-Cal can automatically calibrate the SDS2000X when ambient temperature variations are affecting the measurement accuracy. If the temperature environment that the SDS2000X is working in is not stable, perform the following steps:

1. Press the **Utility** button on the front panel to enter the UTILITY function menu.
2. Press the **Next Page** softkey to go to the second page of the UTILITY function menu.
3. Press the **Quick-Cal** to select **On**.

If the Quick-Cal has been set to **On** before powering on, and the current vertical scale is 2mV or 5mV of any channel, the oscilloscope will perform the quick calibration procedure when it powers on. During the calibration, most of the buttons are disabled.

Also, when the Quick-Cal is **On** and the current vertical scale is 2mV or 5mV of any channel, the oscilloscope will perform the quick calibration procedure if the operating temperature changes by more than 2 degrees.

## To Update Firmware and Configuration

The firmware and configuration can be updated directly via the USB flash drive.

Do the following steps to update the firmware:

1. Insert the USB flash drive containing the firmware and the configure files into the USB host interface on the front panel of the oscilloscope.
2. Press the **Utility** button on the front panel to enter the UTILITY function menu.
3. Press the **Next Page** softkey to go to the second page of the UTILITY function menu.
4. Press the **Next Page** softkey to go to the third page of the UTILITY function menu.
5. Press the **Update** softkey to enter the UPDATE function menu.
6. Press the **Firmware** softkey and it will pop-out the message “**Press ‘Single’ to continue and press ‘Run/Stop’ to exit!**”
7. Press the **Single** button to enter the SAVE/RECALL file system.
8. Turn the **Universal Knob** to select the update file which should be with an ADS postfix; and then press the **Load** softkey to start update the firmware. The process takes about 7 minutes. And during the update, do not turn off the oscilloscope, otherwise the oscilloscope will not restart again.
9. After finishing the update, the screen will display the message “**Update success, please restart the DSO**”, and the oscilloscope will output a buzzing sound.
10. Restart the oscilloscope to finish the firmware update.

Do the following steps to update the configuration:

1. Insert the USB flash drive containing the firmware and the configure files into the USB host interface on the front panel of the oscilloscope.
2. Press the **Utility** button on the front panel to enter the UTILITY function menu.
3. Press the **Next Page** softkey to go to the second page of the UTILITY function menu.
4. Press the **Next Page** softkey to go to the third page of the UTILITY function menu.
5. Press the **Update** softkey to enter the UPDATE function menu.
6. Press the **Configure** softkey to enter the SAVE/RECALL file system.
7. Turn the **Universal Knob** to select the update file which should be with an CFG postfix; and then press the **Load** softkey to start update the firmware. The process takes about 30 seconds.
8. After finishing the update, the screen will pop-out the message “**Update success, please restart the DSO**”, and the oscilloscope will output a buzzing sound.
9. Restart the oscilloscope to finish the configuration update.

## To Perform a Self-Test

Self-tests include screen test, keyboard test, control knobs and LED test.

### Screen Test

1. Press the **Utility** button on the front panel to enter the UTILITY function menu.
2. Press the **Next Page** softkey to go to the second page of the UTILITY function menu.
3. Press the **Next Page** softkey to go to the third page of the UTILITY function menu.
4. Press the **Do Self Test** softkey to enter the SELFTEST function menu.
5. Press the **Screen Test** softkey to enter the screen test interface, as the picture shown below, the screen display is pure red.

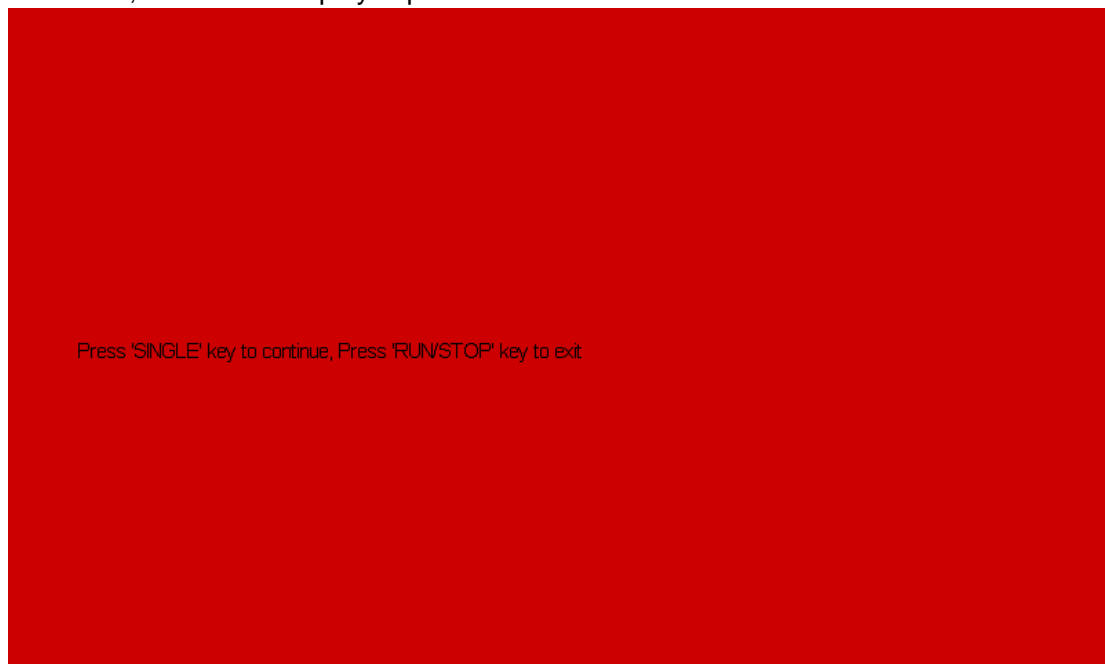

Figure 135: Screen Test

6. Press the **Single** button on the front panel continually as it says in the picture above. The screen displays green, blue and red again. It is easy to check chromatic aberration, stains and scratches of the screen under these condition.
7. Press the **Run/Stop** button on the front panel to exit the screen test program.

## Keyboard Test

Keyboard test is used to test that the keys or the knobs are working correctly.

Do the following steps to do keyboard test:

1. Press the **Utility** button on the front panel to enter the UTILITY function menu.
2. Press the **Next Page** softkey to go to the second page of the UTILITY function menu.
3. Press the **Next Page** softkey to go to the third page of the UTILITY function menu.
4. Press the **Do Self Test** softkey to enter the SELFTEST function menu.
5. Press the **Keyboard Test** softkey to enter the keyboard test interface, as the picture shown below.

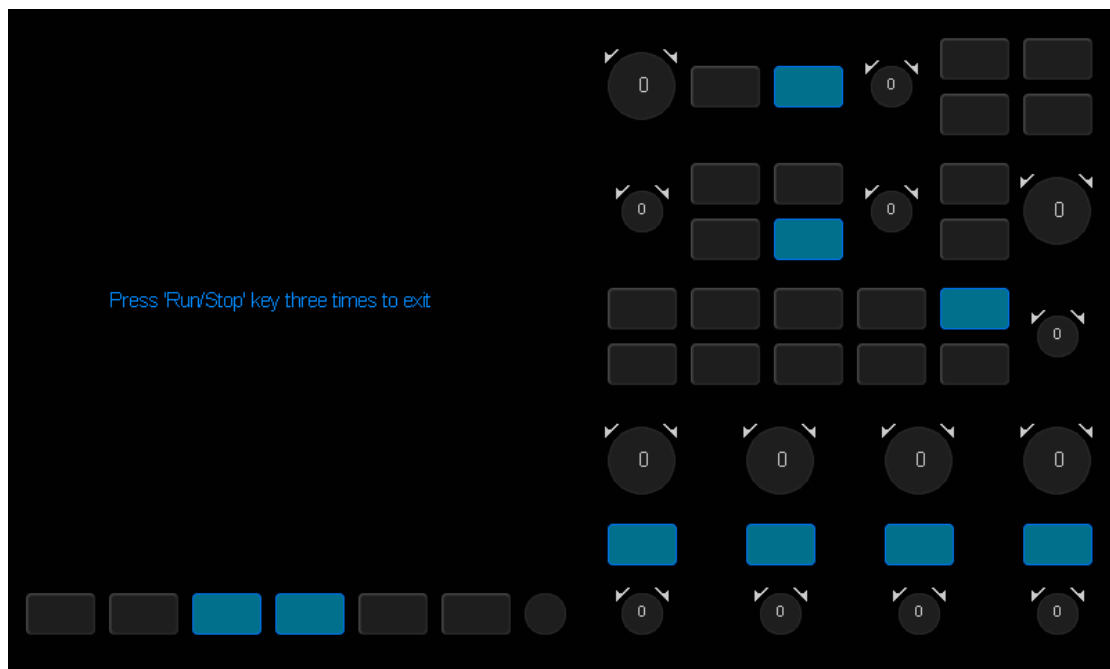

Figure 136: Keyboard Test

6. To perform the knobs and the buttons test.  
Knobs test: The default value is 0. Turn left to increase the value while turn right to decrease; push the knob to set the value to 0. Test every knob randomly.  
Keys test: The first time to press the key to light it up, and a second press to die out. Test every button randomly.
7. Press the **Run/Stop** button 3 times to exit the keyboard test program.

## LED Test

LED test is used to test that if the button lights work well.

1. Press the **Utility** button on the front panel to enter the UTILITY function menu.
2. Press the **Next Page** softkey to go to the second page of the UTILITY function menu.
3. Press the **Next Page** softkey to go to the third page of the UTILITY function menu.
4. Press the **Do Self Test** softkey to enter the SELFTEST function menu.
5. Press the **LED Test** softkey to enter the keyboard test interface, as the picture shown below.

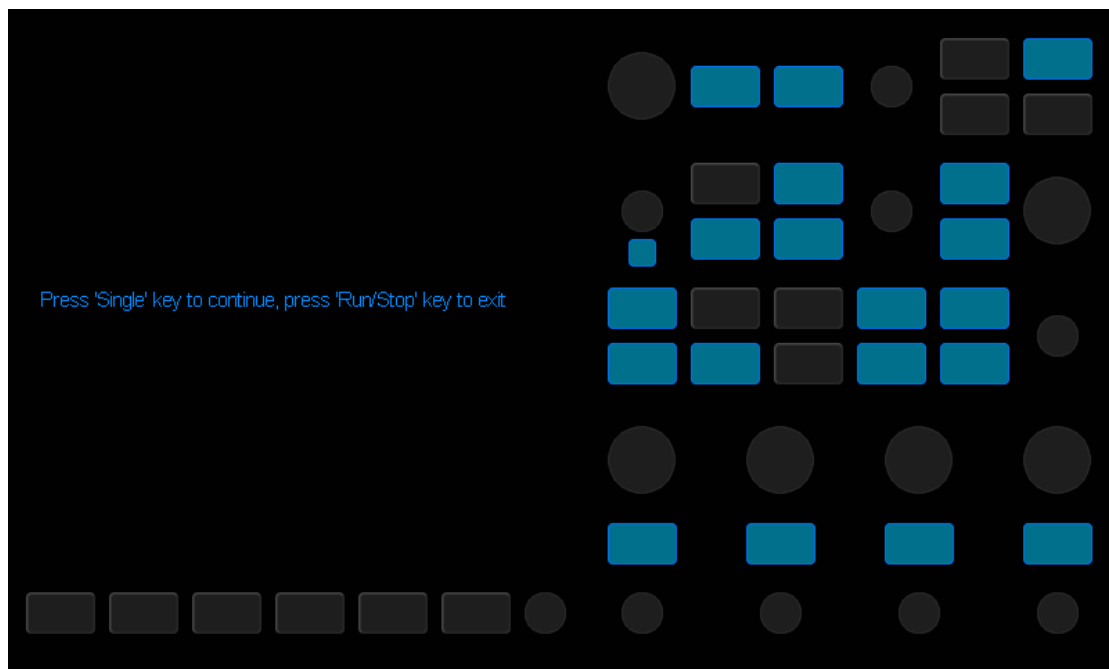

Figure 137: LED Test

6. Following the prompting information displaying on the screen, press the **Single** button continually to light the button lights one by one. After the first press of the **Single** button, the **Run/Stop** button displays red. The second press of the **Run/Stop** button displays green. Then the other button lights will be lit one-by- one. At last all the lights will be lit at the same time.
7. Press the **Run/Stop** button to exit the LED test program.

## To Specify the Screen Saver Time

When the oscilloscope enters the idle state and holds for a certain period of time, the screen saver program will be enabled.

Do the following steps to set the screen saver time:

1. Press the **Utility** button on the front panel to enter the UTILITY function menu.
2. Press the **Next Page** softkey to go to the second page of the UTILITY function menu.
3. Press the **Next Page** softkey to go to the third page of the UTILITY function menu.
4. Press the **Screen Saver** softkey; and then turn the **Universal Knob** to select the desired screen saver time. The screen saver time can be set to **1min**, **5min**, **10min**, **30min**, and **1hour**. Also you can select **Off** to turn off the screen saver function

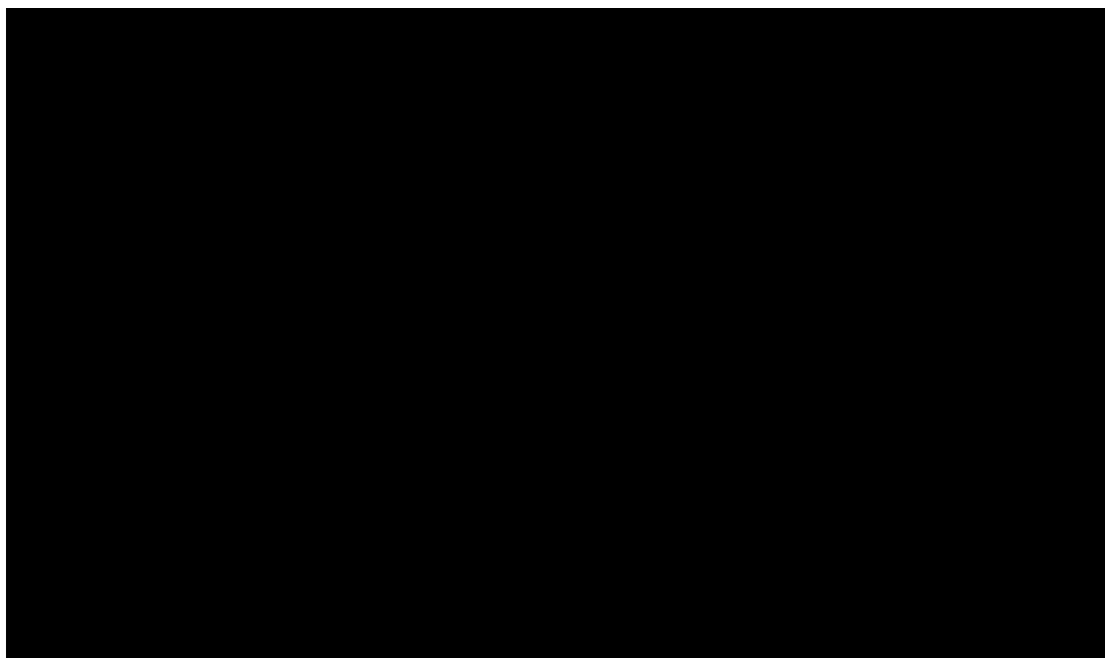

Figure 138: Screen Saver Interface

5. Press any button on the front to exit the screen saver program.



## Option Management

The SDS2000X provides multiple options to fulfill your measurement requirements. Please contact your **SIGLENT** sales representative or **SIGLENT** technical support to order the corresponding options. You can view the options currently installed on the oscilloscope or activate the newly purchased option license codes through this menu.

Do the following steps to install the option on the oscilloscope:

1. Press the **Utility** button on the front panel to enter the UTILITY function menu.
2. Press the **Next Page** softkey to go to the second page of the UTILITY function menu.
3. Press the **Next Page** softkey to go to the third page of the UTILITY function menu.
4. Press the **Options** softkey to enter the OPTION function menu.

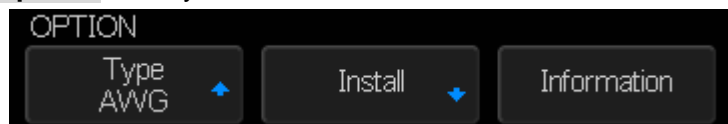

Figure 139: OPTION Function Menu

5. Press the **Type** softkey; then turn the **Universal Knob** to select the module to be installed and push down the knob to confirm.
6. Press the **Install** softkey to enter the LABEL function menu to input the license.

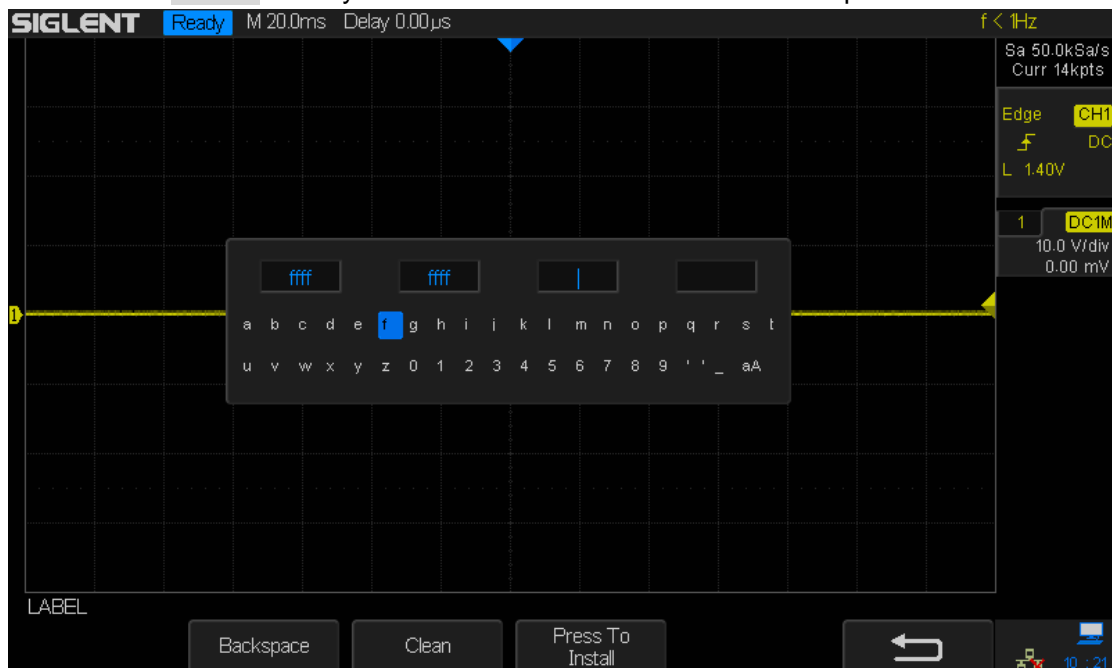

Figure 140: LABEL Function Menu

- Turn the **Universal Knob** to select character
  - Push down the **Universal Knob** to confirm the characters
  - Press the **Press To Install** when license key input done, the screen will pop-out the message **“The license key is installed”**..
  - Press the **Clean** softkey or the **Backspace** softkey to delete the incorrect character.
7. Press the **Information** softkey to view the option information.

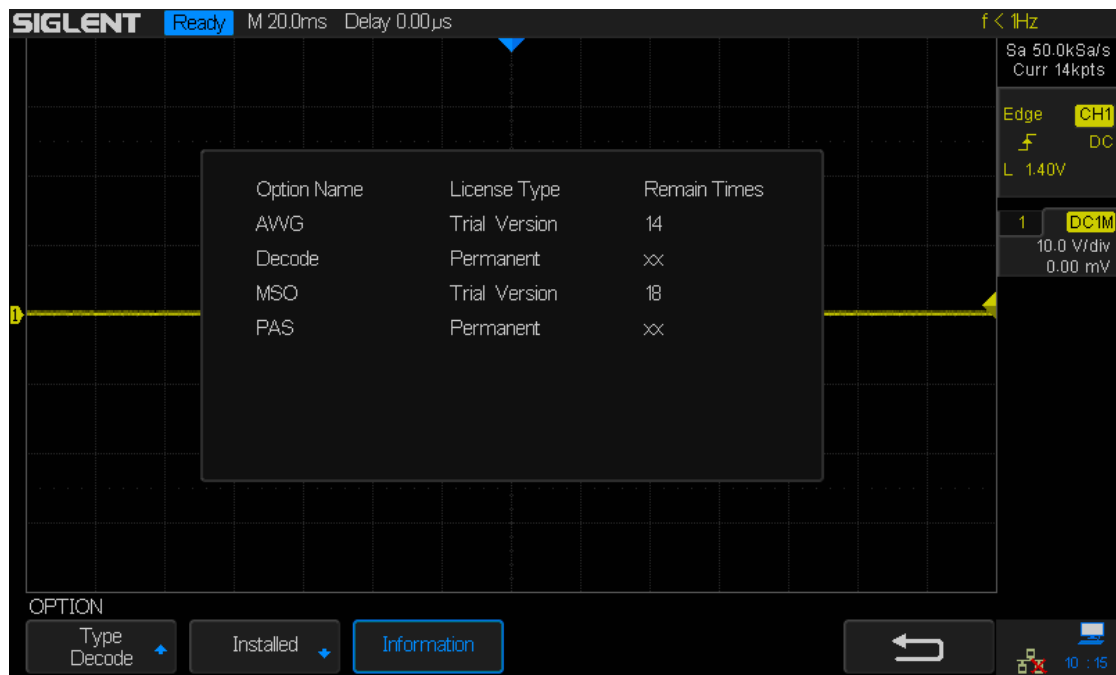

Figure 141: Option Information

## To Use the History Function

The history function can record the waveforms of the input channels before pressing the **Run/Stop** button. In the run state, the oscilloscope records input waveform continually; when the memory becomes full (reaches the maximal frame), the new frames will cover the old frames and keep the latest frames.

To use the History function, the HORIZONTAL **Format** must be set to **YT**.

Do the following steps to record and replay waveform:

- Press the **History** button on the front to enable the History function.
  - When in run state, the waveform will enter the stop state.
  - When in stop state, and then enable the History function, the oscilloscope will remain in the stop state.
  - Press **History** and **STOP** button to turn off History function.
- Press the **List** softkey to turn on or off the list display. The list records the timestamp of every frame. It is displayed and accurate to the microseconds range.

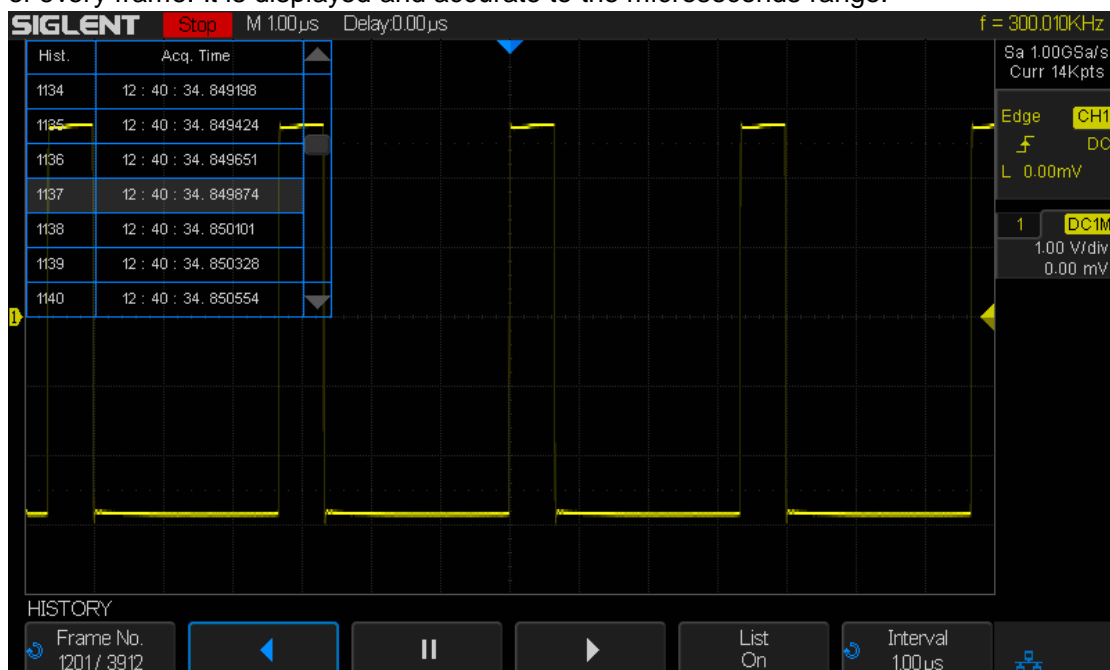





Figure 142: History

- Press the **Frame** softkey; then turn the **Universal Knob** to select the frame to display.
  - The format of the **Frame** is A/B; A is the frame number that displaying on the screen and B is the maximal frame number you can set.
  - The maximum frame number is determined by the current sampling point (**Cur** value) and sampling rate.
  - When pressing the **Run/Stop** button or enable the history function, the maximum number of frames may not be reached because the memory is not filled. Therefore, in order to reach the maximum number of frames, please allow

enough time to wait for the entire acquisition.

4. Press the  softkey to replay the waveform from the current frame to 1.
5. Press the  softkey to stop replay.
6. Press the  softkey to replay the waveform from the current frame to the last frame.

# Arbitrary Waveform Generator

The SDS2000X supports a built-in arbitrary waveform generator. that can be used to source sine, square, ramp, pulse, DC, noise, cardiac, Gauss pulse, exp rise, exp fall and arbitrary waveforms.

The contents of this chapter:

- ◆ [To Set Wave Type and Parameters](#)
- ◆ [To Output Arbitrary Waveform](#)
- ◆ [To Set Output Load](#)
- ◆ [To Recover Default Setup of AWG](#)
- ◆ [To Do AWG Self-Cal](#)

## To Set Wave Type and Parameters

1. Press the **WaveGen** button on the front panel to open the built-in arbitrary waveform generator function. The first press lights up the backlight of the button, opens the output and enters the WAVEFORM function menu. A second press of the **WaveGen** button will turn off the backlight and the output.
2. Press the **Wave Type** softkey; then turn the **Universal Knob** to select the desired waveform and push down the knob to confirm. Press the **Wave Type** softkey continually can also select the waveform type.
3. Press the **Frequency** softkey; then turn the **Universal Knob** to select **Frequency**, **Frequency Fine**, **Period** or **Period Fine** and push down the knob to confirm; turn the **Universal Knob** to select the desired value. Use the same method the set the other parameters.

Wave Type	Character	Frequency Range	Amplitude (High-Z)	Offset (High-Z)
Sine	Use the <b>Universal Knob</b> to adjust the Frequency/ Frequency Fine/ Period/ Period Fine/ Amplitude/ Amplitude Fine/ High-Level/ High-Level-Fine/ Offset/ Offset Fine/ Low-Level/ Low-Level-Fine value.	1uHz~25MHz	4mV~6V	± 3.0V
Square	Use the <b>Universal Knob</b> to adjust the Frequency/ Frequency Fine/ Period/ Period /Fine/ Amplitude/ Amplitude Fine/ High-Level/ High-Level-Fine/ Offset/ Offset Fine/ Low-Level/ Low-Level-Fine/ Duty value.	1uHz~10MHz	4mV~6V	± 3.0V
Ramp	Use the <b>Universal Knob</b> to adjust the Frequency/ Frequency Fine/ Period/ Period Fine/ Amplitude/ Amplitude Fine/ High-Level/ High-Level-Fine/ Offset/ Offset Fine/ Low-Level/ Low-Level-Fine/ Symmetry value.	1uHz~300KHz	4mV~6V	± 3.0V
pulse	Use the <b>Universal Knob</b> to adjust the Frequency/ Frequency Fine/ Period/ Period /Fine/ Amplitude/ Amplitude Fine/ High-Level/ High-Level-Fine/	1uHz~10MHz	4mV~6V	± 3.0V

	Offset/Offset Fine/ Low-Level/ Low-Level-Fine/ Width/ Width Fine value.			
DC	Use the <b>Universal Knob</b> to adjust the Offset value.			± 3.0V
Noise	Use the <b>Universal Knob</b> to adjust the Stdev/ Mean value.			
Cardiac	Use the <b>Universal Knob</b> to adjust the Frequency/ Frequency Fine/ Period/ Period /Fine/ Amplitude/ Amplitude Fine/ High-Level/ High-Level-Fine/ Offset/Offset Fine/ Low-Level/ Low-Level-Fine value.	1uHz~5MHz	4mV~6V	± 3.0V
Gauss Pulse	Use the <b>Universal Knob</b> to adjust the Frequency/ Frequency Fine/ Period/ Period /Fine/ Amplitude/ Amplitude Fine/ High-Level/ High-Level-Fine/ Offset/Offset Fine/ Low-Level/ Low-Level-Fine value.	1uHz~5MHz	4mV~6V	± 3.0V
Exp Rise	Use the <b>Universal Knob</b> to adjust the Frequency/ Frequency Fine/ Period/ Period /Fine/ Amplitude/ Amplitude Fine/ High-Level/ High-Level-Fine/ Offset/Offset Fine/ Low-Level/ Low-Level-Fine value.	1uHz~5MHz	4mV~6V	± 3.0V
Exp Fall	Use the <b>Universal Knob</b> to adjust the Frequency/ Frequency Fine/ Period/ Period /Fine/ Amplitude/ Amplitude Fine/ High-Level/ High-Level-Fine/ Offset/Offset Fine/ Low-Level/ Low-Level-Fine value.	1uHz~5MHz	4mV~6V	± 3.0V
When the Output Load is set to 50Ω, the maximum output level will be reduced by 50%.				

## To Output Arbitrary Waveform

1. Press the **Wave Gen** button on the front panel to enable the AWG function and enter the WAVEFORM function menu.
2. Connect the SDS2000X to a PC which is running the EasyWave software using a USB cable.
3. Double click the EasyWave icon to open the program.
4. Select a waveform file or draw an arbitrary waveform; then click the **Send wave** option which at the bottom of the interface and it will pop-up the dialogue which shows as the picture below:

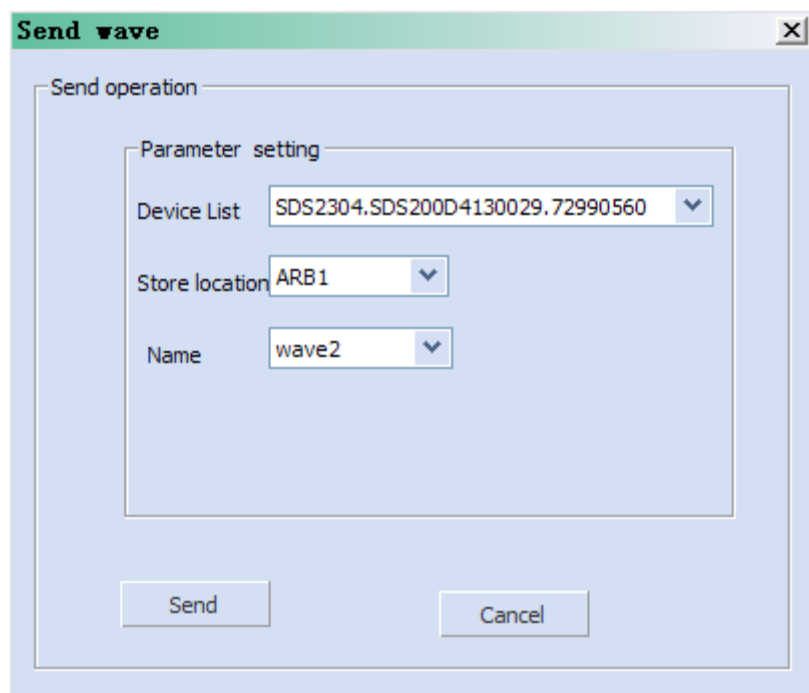

Figure 143: Send Wave Dialogue

5. Click the Store location area and select the location to keep the arbitrary waveform.
6. Click the Send option, then the oscilloscope will pop-out the message “Dealing with waveform data, please wait...”
7. A few seconds later the oscilloscope will prompt “Succeed to save waveform”, and it will enter the WAVEFORM function menu, the Wave Type sets to ArbX (the location chose above)



Figure 144: AWG Menu

8. To delete the arbitrary waveform, press the **Delete** softkey.
9. Press the **Setting** softkey to enter the SETTING function menu.
10. Press the **Output Load** softkey to select **High-Z** or **50Ω**.



## To Set Output Load

11. Press the **Wave Gen** button on the front panel to enter the WAVEFORM function menu.
12. Press the **Setting** softkey to enter the SETTING function menu.
13. Press the **Output Load** softkey to select **High-Z** or **50Ω**.

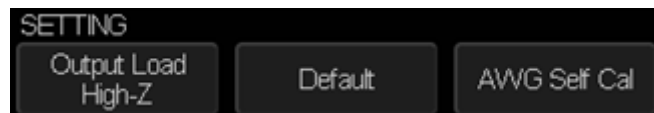

Figure 145: SETTING Function Menu

The output load of the Wave Gen must match with the oscilloscope, or the amplitude of the signal will be incorrect.

## Recover the Default Setup of AWG.

1. Press the **Wave Gen** button on the front panel to enter the WAVEFORM function menu.
2. Press the **Setting** softkey to enter the SETTING function menu.
3. Press the **Default** softkey to recover the default values of Wave Gen (Sine, 1.000 KHz, 4.000Vpp, 0.0mVdc).

## To Do AWG Self-Cal

If the ambient operating temperature changes more than 5° and the instrument runs more than more 30 minutes, run the AWG self cal routine to reduce the environmental thermal change effects

1. Press the **Wave Gen** button on the front panel to enter the WAVEFORM function menu.
2. Press the **Setting** softkey to enter the SETTING function menu.
3. Press the **AWG Self Cal** softkey to perform AWG self-calibration program.





Figure 146: AWG Self Cal

4. When the self-calibration program is completed, press the **Run/Stop** button on the front panel to exit the interface according to the information on the screen.

## Default Setup

Press the **Default** button on the front panel to set the SDS2000X back to the factory default values as shown below:

<b>Horizontal</b>	
T/div	1 $\mu$ s/div
Delay	0 S
Zoom	Off
Format	Y-T
<b>Vertical</b>	
Channel on/off	CH1
V/div	1 V/div
Offset	0 V
Coupling	DC
BW Limit	Full
Adjust	Coarse
Probe	1X
Impedance	1 M $\Omega$
Unit	V
Invert	Off
<b>Acquire</b>	
Acquisition	Normal
Sin $\times$ /x	Sin $\times$ /x
Mem Depth	14 Mpts
<b>Trigger</b>	
Type	Edge
Source	CH1
Slope	Rising
Holdoff	Off
Coupling	DC
Noise Reject	Off
Mode	Auto
<b>Display</b>	
Type	Vectors
Color	Off

Persist	Off
Grid	
Intensity	50%
Brightness	40%
Transparence	50%
<b>Cursor</b>	
Mode	Off
Type	X1
Source	CH1
X1	-3.5 $\mu$ s
X2	3.5 $\mu$ s
<b>Save/Recall</b>	
Type	Setups
Save To	Internal
Setup	NO.1
<b>Utility</b>	
<b>IO Set</b>	
USB Device	USBTMC
Aux Output	Trig Out
<b>Sound</b>	
Sound	On
<b>Pass/Fail</b>	
Enable Test	Off
Source	CH1
Operate	Off
Mes Display	Off
X Mask	0.2
Y Mask	0.2
Location	Internal
Fail To Stop	Off
Output	
<b>System Setup</b>	
Quick-Cal	Off
Screen Saver	30 min
<b>Math</b>	

Operate	Off
<b>+</b>	
Source A	CH1
Source B	CH1
Invert	Off
V/div	1.00 V/div
offset	0V
<b>-</b>	
Source A	CH1
Source B	CH1
Invert	Off
V/div	1.00 V/div
offset	0 V
<b>*</b>	
Source A	CH1
Source B	CH1
Invert	Off
V/div	1.00 V <sup>2</sup> /div
offset	0 V <sup>2</sup>
<b>/</b>	
Source A	CH1
Source B	CH1
Invert	Off
V/div	1.0/div
offset	0
<b>FFT</b>	
Source	CH1
Window	Hanning
Horizontal	1X
Vertical Scale	20 dBVrms
Display	Split
Horizontal Scale	100 MHz
<b>d/dt</b>	
Source	CH1
Vertical Scale	1.00 (MV/S)/div
Vertical Offset	0
dx	0.2 div
<b>∫dt</b>	
Source	CH1
Offset	0

Vertical Scale	1.00 eve/div
Vertical Offset	0
√	
Source	CH1
Vertical Scale	1.00 V <sup>1/2</sup> /div
Vertical Offset	0
<b>REF</b>	
Source	CH1
Location	REF A
Display	Off
<b>Decode</b>	
<b>Serial 1</b>	
Serial	I2C
Display	Off
List	Off
<b>Serial 2</b>	
Serial	SPI
Display	Off
List	Off
<b>I2C</b>	
SCK	CH1
Threshold	1.60 V
SDK	CH2
Threshold	1.60 V
Address	7bits
<b>SPI</b>	
CLK	CH1
Threshold	1.60 V
Edge Select	Rising
MISO	CH2
Threshold	1.60 V
MOSI	CH1
Threshold	1.60 V
CS Type	CS
CS	CH2
Idle Level	Low
Bit Order	LSB
Data Length	8

<b>UART/RS232</b>	
RX	CH1
Threshold	1.60 V
TX	CH2
Threshold	1.60 V
Bound	9600
Parity Check	None
Stop Bit	1
Idle Level	Low
Data Length	8
<b>CAN</b>	
CAN-H	CH1
Threshold	1.60 V
CAN-L	CH2
Threshold	1.60 V
Bound	100kb/S
Decode Source	CAN_H
<b>LIN</b>	
Source	CH1
Threshold	1.60 V
Baud	2400
<b>Wave Gen</b>	
Function	Off
Wave Type	Sine
Output Load	High-Z
<b>Sine</b>	
Frequency	1 KHz
Amplitude	4 Vpp
Offset	0 Vdc
<b>Square</b>	
Frequency	1 KHz
Amplitude	4 Vpp
Offset	0 Vdc
Duty	50%
<b>Ramp</b>	
Frequency	1 KHz
Amplitude	4 Vpp
Offset	0 Vdc
Symmetry	50%

<b>Pulse</b>	
Frequency	1 KHz
Amplitude	4 Vpp
Offset	0 Vdc
Width	200 $\mu$ s
<b>DC</b>	
Offset	0.0 mVdc
<b>Noise</b>	
Stdev	448 mV
Mean	0 mV
<b>Cardiac</b>	
Frequency	1 KHz
Amplitude	4 Vpp
Offset	0 Vdc
<b>Gauss Pulse</b>	
Frequency	1 KHz
Amplitude	4 Vpp
Offset	0 Vdc
<b>Exp Rise</b>	
Frequency	1 KHz
Amplitude	4 Vpp
Offset	0 Vdc
<b>Exp Fall</b>	
Frequency	1 KHz
Amplitude	4 Vpp
Offset	0 Vdc



---

# Troubleshooting

Possible problems and solutions are listed below. If one of these problems is encountered, please check each possible solution listed below it. If the issue is not resolved, please contact your dealer or **SIGLENT** directly.

1. **The screen remains dark after power on**
  - 1) Check if the power is correctly connected.
  - 2) Check if the power switch is faulty.
  - 3) Check whether the fuse is burned out. If the fuse is defective please replace with a fuse of the same size and ratings. If you have questions, please contact **SIGLENT**.
  - 4) Restart the instrument after completing the steps listed above.
  - 5) If these steps do not solve the problem, please contact **SIGLENT**.
  
2. **After the signal is sampled, there is no corresponding waveform displaying**
  - 1) Check to make certain the probe is correctly connected to the signal connecting cord.
  - 2) Check to make certain the signal connecting cord is correctly connected to the BNC input connector.
  - 3) Verify that the probe is correctly connected to the item-under-test.
  - 4) Verify that there is signal generated from the item-under-test.
  - 5) Resample the signal.
  
3. **The voltage amplitude measured is higher or lower than the actual value (the error usually occurs in use of the probe)**

Verify that the attenuation coefficient setting of the current channel matches with the attenuation ratio of the probe.
  
4. **A waveform is displayed but is not stable**
  - 1) Check the trigger source: check whether the "Source" in menu of "TRIG" is the actual operating channel.
  - 2) Check to see if the waveform is similar to what is expected. Make certain that the time base is in the expected range. It is common to not see a signal if the time base is set to sweep too fast.
  - 3) Check the trigger type: "Edge" trigger suits to general signal and "Video" trigger suits to video signal. The correct trigger type setting can be important in obtaining a stable display.
  - 4) Change the setting of trigger hold-off.

**5. No display after pressing Run/Stop**

Check whether the trigger Mode is “Normal” or “Single”, and if the trigger level exceeds the waveform range. If the trigger level is set too high, adjust the trigger level to the middle of the trace or change the trigger Mode to “Auto”.

Note: Pressing Auto Setup might bring the waveform into view.

**6. The displayed signal looks like a ladder**

- 1) The horizontal time base may be set too slow. Try increasing the time base sweep speed to improve the resolution of the displayed trace.
- 2) Lines between sampled points may cause the display to appear as a ladder when the display is in the Vector mode. Try using the Dots mode to see if this results in a more suitable display.

**7. Fail to connect PC through USB:**

Check the **I/O Setting** in **Utility** to make sure whether the setting in **USB Device** matches the device currently connected. If needed, restart the oscilloscope.

**8. External USB drive is not recognized**

- 1) Check to make certain the USB flash drive is operating correctly in another instrument or PC.
- 2) Check if the USB Host can work normally.
- 3) Make sure the USB disk being used is of the flash type, the instrument does not support USB of hard disk type.
- 4) Make sure the system format of used USB disk is FAT32.
- 5) Restart the instrument and then insert the USB to verify operation.
- 6) If a problem persists, please contact **SIGLENT**.