

SPS5000X Series wide range programmable Switching DC Power Supply datasheet

Datasheet





















Product Overview

The SPS5000X-Series is a programmable Switching DC Power supply series that provides a wide range of output power using single-channel and multi-channel output configurations coupled with constant power capability. The series of power supplies includes sixteen models with voltages to 160 VDC and power to 1080 W. The SPS5000X supplies can be connected in series (2 units) or in parallel (3 units) to meet the requirements of 0~320V and 0~270A, with a maximum combined power of 3240W.

The SPS5000X Series has a high brightness 2.4 inch OLED display, a user-friendly human-computer interface that enable easy control and performance monitoring. The SPS5000X provides high resolution voltage and current settings, adjustable slew rates, list sequence programming from the front panel or over the standard LAN/ USB interface, analog control, and over-voltage, current, power, and temperature protection. These features make the series an ideal choice for a variety of demanding markets, including Commercial Industrial, Education, Energy and Power Generation, laboratory general testing, the LED lighting industry, and automotive electronics.

Main Features

-  Rated Output Voltage: 40V, 50V, 80V, 160V
-  Rated Output Power: 180W, 360W, 720W, 1080W
-  Wide range of output voltage and current, high efficiency power supply
-  CV, CC priority mode selection, better protection of equipment under test
-  Load transient recovery time (Load change from 50~100%) <1ms
-  Adjustable slew rate of output voltage and current
-  Setting and readback resolution: 1 mV, 1 mA
-  User enabled internal output discharge circuit to accelerate the down programming of the output voltage
-  Remote Voltage Sensing
-  List function up to 50 steps; can be created from the front panel or by importing list sequence files from a USB memory device
-  External analog voltage and resistor control of voltage or current output
-  External voltage and current monitoring output
-  OVP, OCP, LPP, OTP protection.
-  2.4-inch OLED high brightness liquid crystal display, 170-degree viewing angle
-  Standard Interface: USB, LAN, Analog Control Interface
-  Optional Interface: USB-GPIB module
-  1/2, 1/3, 1/6 rack mount size
-  Embedded Web Server offers remote control through a web browser without the need for the driver or software

Design Features

Constant Output Power

In constant output power mode, the voltage and current range is switched automatically to maximize the voltage and current without sacrificing the supply's output power. This mode enables the supply to provide a higher output voltage at lower current and a higher output current at lower voltage. Compared to the traditional rectangular output range of most supplies, the SPS5000X series power supply provides a wider voltage and current output range, which greatly increases the utilization of the power supply.

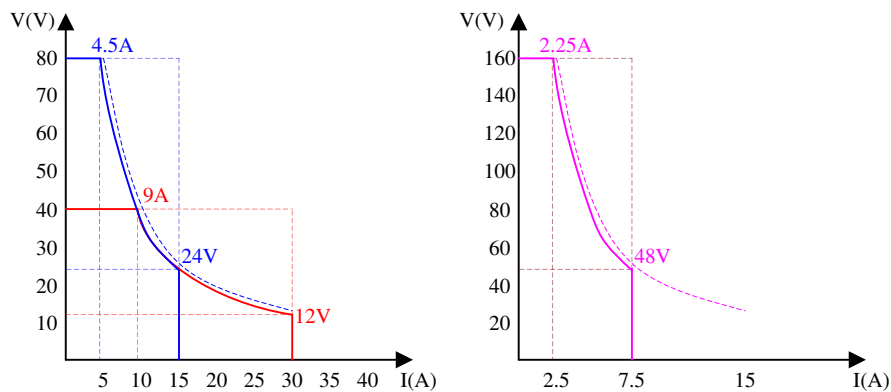

80V 15A/ 40V 30A Output Operating Area

160V 7.5A Output Operating Area

Adjustable Output Voltage, Current up/down Slew Rate

The SPS5000X series supports custom setting of the rise/fall slew rate of voltage/current to verify the performance of the object under test as the voltage/current changes. This feature can effectively prevent the damage caused by inrush current to the DUT in applications such as the testing of capacitive current absorbing devices.

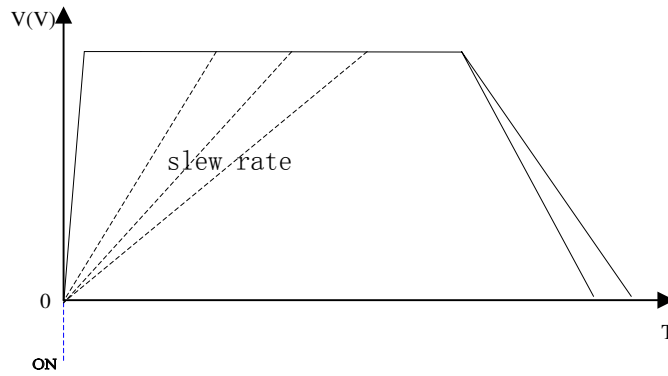

Output voltage, current up/down slew rate

CV/CC Priority Mode

When the SPS5000X series power supply is set to CC priority mode, at the power output-on stage, it is able to operate under CC priority to limit the inrush current spike and overshoot voltage effectively when the power output is turned on.

In CV priority mode, the output voltage reaches the set voltage value quickly. In some applications, such as LED testing, when the power output is started, the surge current and overshoot voltage will appear when the voltage reaches the on-state voltage of the LEDs.



CV priority mode



CC priority mode

Adjustable Output Resistance

The SPS5000X series power supply supports software - defined settings for output internal resistance. It can be used as an internal resistance in series with the positive output pole. At this point, the power supply is equivalent to the power supply containing internal resistance, such as lead-acid battery or lithium battery.

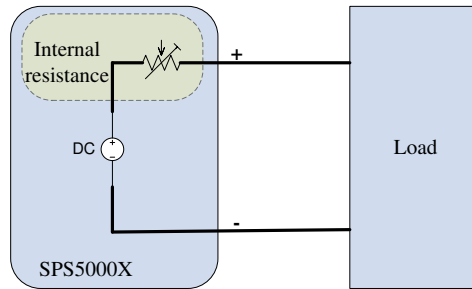

Internal resistance setting

Built-in Discharge Circuit

SPS5000X series power supply is designed with a discharge circuit in parallel with the output terminal, which can be equivalent to a parallel resistance. When the power is turned off and the load is disconnected, the discharge circuit will discharge the power in the output filter capacitor. Without the discharge circuit, the output capacitance will remain charged, which may pose a dangerous voltage at the output terminals for a period of time. The discharge circuit can also be used to adjust the voltage down slew rate. This function is enabled in the menu by the user.

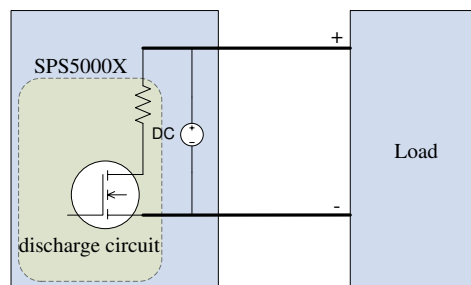

Discharge circuit

Intuitive List Operation Function

By editing the single-step setting value, duration, and slew rate, the List function can generate multiple complex sequences to meet complex test requirements. The user can edit the sequence by 50 steps natively or import the List sequence file via USB for multi-step running.

The minimum precision of delay time is 1mS. The minimum running time is 1 second.

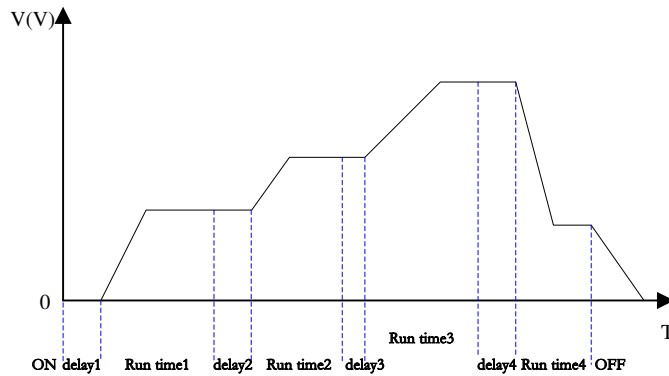

List mode

External Analog Control

Four operating modes can be implemented using the analog port on the back of the unit; voltage-controlled voltage, voltage-controlled current, resistance-controlled voltage, and resistance-controlled current. In external voltage control mode, when the terminal is connected with adjustable voltage of 0-10V, it can be used to adjust the output from 0 to full range (10V corresponds to the voltage or current value of the full range of the power supply).

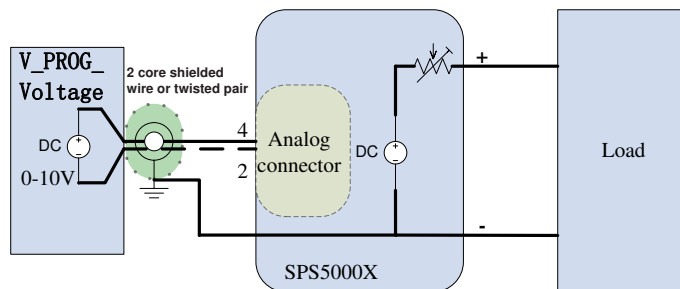

External voltage programming voltage output

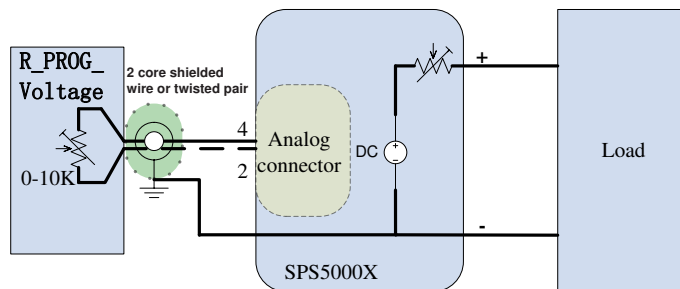

External resistance programming voltage output

Voltage, Current Monitor Output

The voltage and current output monitoring terminal output is a 0-10V voltage analog signal with the corresponding value representing the output current or voltage of the power supply from 0 to full range. The user can connect to one of Siglent's DMMs or oscilloscopes to display the output current or voltage changes.

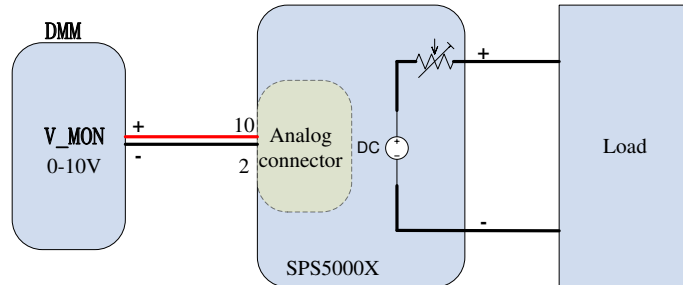

External DMM Monitoring of the Output Voltage

Series and Parallel Function

Multiple single-channel SPS5000X series modules can be connected in series (2 units max.) or in parallel (3 units max), to increase the total output voltage, current and power. The SPS5000X series offers a highly flexible configuration concept to provide high power density that meets the needs of many applications.

(Typically, outputs of the supply float so the negative terminals are not connected to chassis ground. The negative terminals can also be connected to chassis ground.)

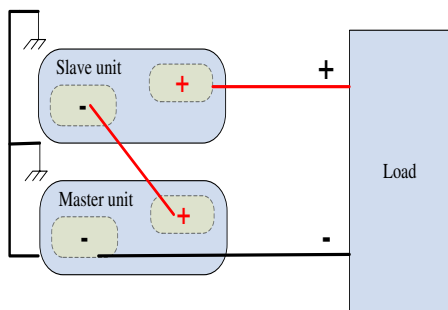

Series Connection

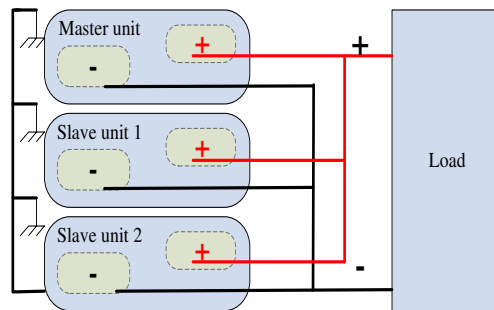

Parallel Connection

SPS5000X dual-channel model supports two-channel serial and parallel mode to increase voltage or current output.

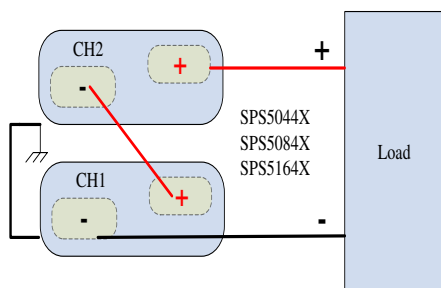

Dual-channel Series Connection

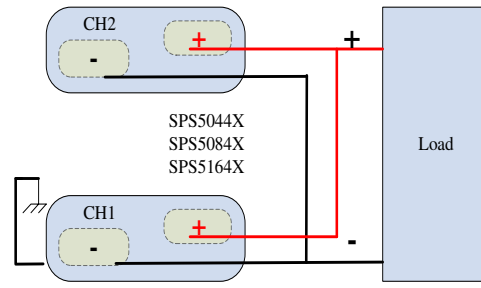

Dual-channel Parallel Connection

SPS5000X three-channel model supports the combination of CH1,CH2 channel series and parallel mode and CH1,CH2,CH3 parallel mode for increased voltage or current output.

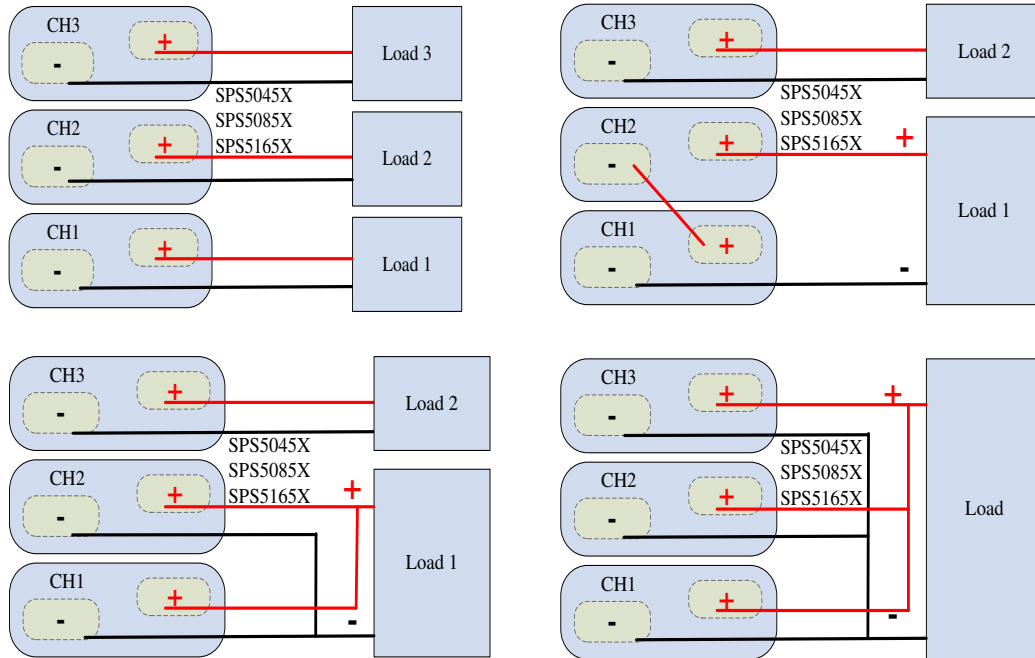

SPS5000X three-channel model

Output ON/OFF delay

Using the power output delay function, the output the output power up and power down of multiple supplies can be precisely set relative to each other. The delay can be set using analog control or programmed through the USB or Ethernet ports.

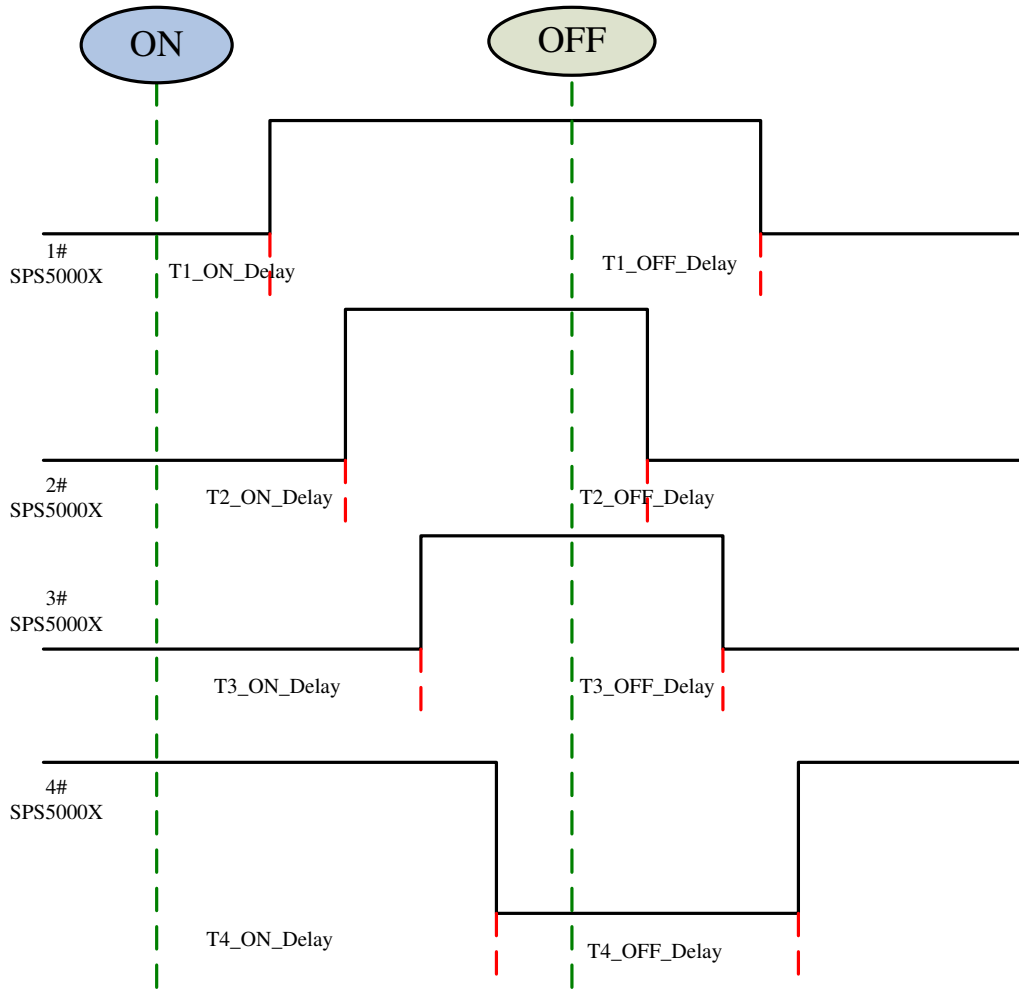

Multiple SPS5000X output delay control examples

SPS5000X power supply 2 channel output, 3 channel output machine internal configuration output 2 or 3 channel up and down power sequence function.



SPS5085X 3 channel List delay control output.

Multiple Policy Protection Patterns

The protection functions of the power supply include over current protection (OCP), over voltage protection (OVP) and over temperature protection (OTP). If protection occurs, the power supply will turn off the output and enter protection mode. Protection can be released by pressing the Esc key for at least 2 seconds. Upon entering the Limited power protection (LPP), the system will start the power limitation mode, the maximum output power is about 105% of the rated power

Save/Recall Setting Parameters

The power supply allows users to save multiple types of files to memory for later recall. The power supply provides a non-volatile internal memory and an external memory via the USB port with a user provided USB memory device.

Rich Interface

The power supply includes USB and Ethernet communication interfaces as standard, and a

USB-GPIB converter module as optional. The embedded Web Server enables control and monitor of the power supply directly from a web browser, eliminating the need to install software drivers or applications.

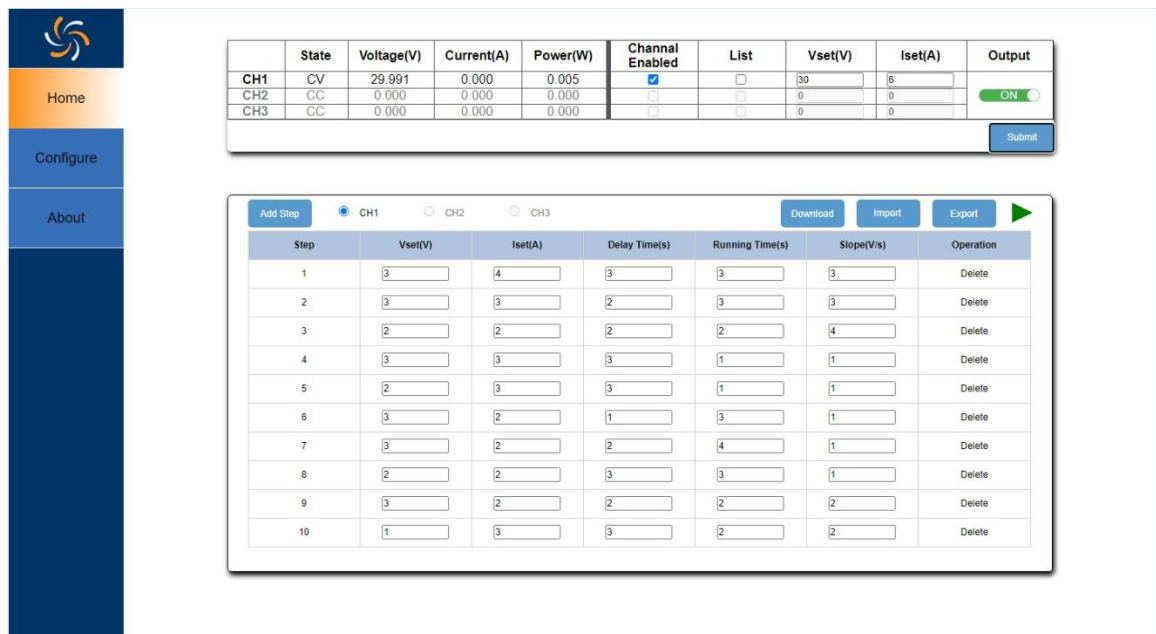

The screenshot displays the web server interface for the power supply. On the left is a navigation menu with 'Home', 'Configure', and 'About' options. The main area is divided into two sections:

Control Panel: A table showing the status of three channels (CH1, CH2, CH3). CH1 is in CV mode with a voltage of 29.991V, current of 0.000A, and power of 0.005W. CH2 and CH3 are in CC mode with 0.000V, 0.000A, and 0.000W. A 'Submit' button is located at the bottom right of this section.

	State	Voltage(V)	Current(A)	Power(W)	Channel Enabled	List	Vset(V)	Iset(A)	Output
CH1	CV	29.991	0.000	0.005	<input checked="" type="checkbox"/>	<input type="checkbox"/>	30	6	<input type="checkbox"/>
CH2	CC	0.000	0.000	0.000	<input type="checkbox"/>	<input type="checkbox"/>	0	0	<input type="checkbox"/>
CH3	CC	0.000	0.000	0.000	<input type="checkbox"/>	<input type="checkbox"/>	0	0	<input type="checkbox"/>

Sequence Table: A table for defining a test sequence with 10 steps. Each step includes fields for Vset(V), Iset(A), Delay Time(s), Running Time(s), Slope(V/s), and an Operation (Delete). The 'Add Step' button is at the top left, and 'Download', 'Import', and 'Export' buttons are at the top right.

Step	Vset(V)	Iset(A)	Delay Time(s)	Running Time(s)	Slope(V/s)	Operation
1	3	4	3	3	3	Delete
2	3	3	2	3	3	Delete
3	2	2	2	2	4	Delete
4	3	3	3	1	1	Delete
5	2	3	3	1	1	Delete
6	3	2	1	3	1	Delete
7	3	2	2	4	1	Delete
8	2	2	3	3	1	Delete
9	3	2	2	2	2	Delete
10	1	3	3	2	2	Delete

Web Server Interface

Specifications

Unless otherwise noted, all specifications are guaranteed within the temperature range of 25°C ± 5 °C with warm-up time of 30 minutes.

Model	SPS5041X	SPS5042X	SPS5043X	SPS5044X	SPS5045X	units
Output channel	1			2	3	CH
Rated output voltage	40					V
Rated output current	30	60	90	30		A
Total rated output power	360	720	1080	720	1080	W
Power Ratio	3.33					
C.V Mode						
Line Regulation	18 (From 90 ~ 132Vac or 170 ~ 265Vac, constant load)					mV
Load Regulation	20 (From No load to Full load, constant input voltage)					mV
Ripple and Noise (*1)	(Noise Bandwidth 20MHz; Ripple Bandwidth 1MHz)					
RIPPLE(pk to pk)	60	80	100	60		mV
RMS RIPPLE	7	11	14	7		mV
Voltage programming Accuracy	*0.1%±10					mV
Voltage programming resolution	1					mV
Voltage Readback Accuracy	*0.1%±20					mV
Voltage Readback resolution	1					mV
Temperature coefficient	100ppm/°C from rated output voltage following 30-minute warm-up.					ppm/°C
Remote compensation voltage (single wire)	0.6					V
Rise Time	10% ~ 90% of rated output voltage, rated resistance load					
Rated Load	50					mS
No Load	50					mS
Fall Time	90% ~ 10% of rated output voltage, rated resistance load					
Rated Load	50					mS
No Load	500					mS
Transient response time	1 (Time for recovery to within 0.1% + 10mV of its rated output against current of 50% ~ 100%.)					mS
C.C Mode						
Line Regulation	40	75	110	40		mA
Load Regulation	40	75	110	40		mA
Ripple and Noise						
r.m.s	72	144	216	72		mA

Current Setting Accuracy	*0.1%±30	*0.1%±60	*0.1%±100	*0.1%±30	mA
Current programming resolution	1				mA
Current Readback Accuracy	*0.1%±40	*0.1%±70	*0.1%±100	*0.1%±40	mA
Current Readback resolution	1				mA
Temperature coefficient	200ppm/°C from rated output current following 30-minute warm-up.				ppm/°C
Protection Function					
OVP					
Setting Range	4~44				V
Setting Accuracy	± (2% of rated output voltage)				
OCP	The maximum output current limit of the front output terminal is 10A.				
Setting Range	3~30	6~60	9~90	3~30	A
Setting Accuracy	± (2% of rated output current)				
OTP	Over temperature alarm and shut off output.				
Low AC Input Protection	Shut off output.				
LPP	The over power limit is approximately 105% of the rated output power.				
Rising/Falling Voltage Slew Rate: Only applicable if V-I Mode is set to CV Slew Rate Priority.					
	0.1~80				V/s
Rising/Falling Current Slew Rate: Only applicable if V-I Mode is set to CC Slew Rate Priority.					
	0.01~60.00	0.01~120.00	0.01~180.00	0.01~60.00	A/s
Output resistance setting					
	0~1.5	0~0.75	0~0.5	0~1.5	Ω
Efficiency					
100Vac	>77				%
200Vac	>79				%

Model	SPS5051X	SPS5081X	SPS5082X	SPS5083X	SPS5084X	SPS5085X	units
Output channel	1	1			2	3	CH
Rated output voltage	50	80					V
Rated output current	10	15	30	45	15		A
Total rated output power	180	360	720	1080	720	1080	W
Power Ratio	2.77	3.33					
C.V Mode							
Line Regulation	3	40 (From 90 ~ 132Vac or 170 ~ 265Vac, constant load)					mV
Load Regulation	10	40 (From No load to Full load, constant input voltage)					mV
Ripple and Noise (*1)	(Noise Bandwidth 20MHz; Ripple Bandwidth 1MHz)						
RIPPLE(pk to pk)	45	60	80	100	60		mV
RMS RIPPLE	4	7	11	14	7		mV
Voltage programming Accuracy	*0.1%±10						mV
Voltage programming resolution	1						mV
Voltage Readback Accuracy	*0.1%±20						mV
Voltage Readback resolution	1						mV
Temperature coefficient	100ppm/°C from rated output voltage following 30-minute warm-up.						ppm/°C
Remote compensation voltage (single wire)	0.6						V
Rise Time	10% ~ 90% of rated output voltage, rated resistance load						
Rated Load	50						mS
No Load	50						mS
Fall Time	90% ~ 10% of rated output voltage, rated resistance load						
Rated Load	50						mS
No Load	500						mS
Transient response time	1 (Time for recovery to within 0.1% + 10mV of its rated output against current of 50% ~ 100%.)						mS
C.C Mode							
Line Regulation	8	18	32	45	18		mA
Load Regulation	10	18	32	45	18		mA
Ripple and Noise							
r.m.s	10	27	54	81	27		mA
Current Setting Accuracy	*0.1%±10	*0.1%±10	*0.1%±30	*0.1%±40	*0.1%±10		mA
Current programming resolution	1						mA

Current Readback Accuracy	*0.1%±20	*0.1%±20	*0.1%±40	*0.1%±50	*0.1%±20	mA
Current Readback resolution	1					mA
Temperature coefficient	200ppm/°C from rated output current following 30-minute warm-up.					ppm/°C
Protection Function						
OVP						
Setting Range	5~55	8~88				V
Setting Accuracy	± (2% of rated output voltage)					
OCP	The maximum output current limit of the front output terminal is 10A.					
Setting Range	1~11	1.5~16.5	3~33	4.5~49.5	1.5~16.5	A
Setting Accuracy	± (2% of rated output current)					
OTP	Over temperature alarm and shut off output.					
Low AC Input Protection	Shut off output.					
LPP	The over power limit is approximately 105% of the rated output power.					
Rising/Falling Voltage Slew Rate: Only applicable if V-I Mode is set to CV Slew Rate Priority.						
	0.1~100	0.1~160				V/s
Rising/Falling Current Slew Rate: Only applicable if V-I Mode is set to CC Slew Rate Priority.						
	0.01~20.00	0.01~30.00	0.01~60.00	0.01~90.00	0.01~30.00	A/s
Output resistance setting						
	0~6	0~6	0~3	0~2	0~6	Ω
Efficiency						
100Vac	>77	>77				%
200Vac	>79	>79				%

Model	SPS5161X	SPS5162X	SPS5163X	SPS5164X	SPS5165X	units
Output channel	1			2	3	CH
Rated output voltage	160					V
Rated output current	7.5	15	22.5	7.5		A
Total rated output power	360	720	1080	720	1080	W
Power Ratio	3.33					
C.V Mode						
Line Regulation	80 (From 90 ~ 132Vac or 170 ~ 265Vac, constant load)					mV
Load Regulation	80 (From No load to Full load, constant input voltage)					mV
Ripple and Noise (*1)	(Noise Bandwidth 20MHz; Ripple Bandwidth 1MHz)					
RIPPLE(pk to pk)	60	80	100	60		mV
RMS RIPPLE	12	15	20	12		mV
Voltage programming Accuracy	*0.1%±100					mV
Voltage programming resolution	1					mV
Voltage Readback Accuracy	*0.1%±100					mV
Voltage Readback resolution	1					mV
Temperature coefficient	100ppm/°C from rated output voltage following 30-minute warm-up.					ppm/°C
Remote compensation voltage (single wire)	0.6					V
Rise Time	10% ~ 90% of rated output voltage, rated resistance load					
Rated Load	100					mS
No Load	100					mS
Fall Time	90% ~ 10% of rated output voltage, rated resistance load					
Rated Load	100					mS
No Load	1000					mS
Transient response time	2 (Time for recovery to within 0.1% + 10mV of its rated output against current of 50% ~ 100%.)					mS
C.C Mode						
Line Regulation	12	19	26	12		mA
Load Regulation	12	19	26	12		mA
Ripple and Noise						
r.m.s	15	30	45	15		mA
Current Setting Accuracy	*0.1%±5	*0.1%±15	*0.1%±20	*0.1%±5		mA
Current programming resolution	1					mA
Current Readback Accuracy	*0.1%±5	*0.1%±15	*0.1%±20	*0.1%±5		mA
Current Readback resolution	1					mA
Temperature coefficient	200ppm/°C from rated output current following 30-minute warm-up.					ppm/°C
Protection Function						

OVP					
Setting Range	16~176				V
Setting Accuracy	± (2% of rated output voltage)				
OCP	The maximum output current limit of the front output terminal is 10A.				
Setting Range	0.75~8.25	1.5~16.5	2.25~24.75	0.75~8.25	A
Setting Accuracy	± (2% of rated output current)				
OTP	Over temperature alarm and shut off output.				
Low AC Input Protection	Shut off output.				
LPP	The over power limit is approximately 105% of the rated output power.				
Rising/Falling Voltage Slew Rate: Only applicable if V-I Mode is set to CV Slew Rate Priority.					
	0.1~320				V/s
Rising/Falling Current Slew Rate: Only applicable if V-I Mode is set to CC Slew Rate Priority.					
	0.01~15.00	0.01~30.00	0.01~45.00	0.01~15.00	A/s
Output resistance setting					
	0~24	0~12	0~8	0~24	Ω
Efficiency					
100Vac	>80				%
200Vac	>82				%

***1: Use (1:1) probe to measure at the positive and negative poles of sense terminal.**

	1-channel	2-channel	3-channel				
Series and parallel capability							
parallel	3	none		Units			
Series	2	none		Units			
Channels in series and parallel	none	Connect through an analog interface.					
Analog programming and monitoring							
External Voltage Control of the Voltage Output	Accuracy: +0.5% of rated output voltage						
External Voltage Control of the Current Output	Accuracy: +1% of rated output current						
External Resistance Control of the Voltage Output	Accuracy: +1.5% of rated output voltage						
External Resistance Control of the Current Output	Accuracy: +1.5% of rated output current						
Output Voltage/ Current monitor accuracy	±1			%			
Shutdown control	Close output with LOW (0V~0.5V) or short circuit						
Output On/Off control	Use LOW (0V~0.5V) or short circuit to turn on the output. Use HIGH (4.5V~5V) or open circuit to turn off the output.						
CV/CC/ERR/ ON/OFF Status	Photo coupler open collector output; Maximum voltage 30V, maximum sink current 8mA.						
Input Characteristics							
Normal Rated Input	100Vac ~ 240Vac, 50Hz ~ 60Hz, Single-phase						
Input Voltage Range	90Vac ~ 265Vac						
Input Frequency Range	47Hz ~ 63Hz						
Maximum Input Current of different power models	180W	360W	720W	1080W	360W*2CH	360W*3CH	
100Vac	2.5	5	10	15	10	15	A
200Vac	1.25	2.5	5	7.5	5	7.5	A
Surge Current	<15A.	<25A.	<50A.	<75A.	<50A.	<75A.	
Maximum Input Power	250	500	1000	1500	1000	1500	VA
Power factor							
100Vac	0.99						
200Vac	0.98						
Hold-up time	≥20ms						
Interface capability							
USB	Type A: HOST, Type B: DEVICE, SPEED: 1.1/2.0						
LAN	MAC address, Gateway IP address, Instrument IP address, Subnet Mask						

GPIB	Optional: USB-GPIB adapter					
Environment Condition						
Operating Temperature	0°C ~ 50°C					
Storage temperature	-25°C ~ 70°C					
Operating humidity	20% ~ 85% RH; No condensation					
Storage humidity	90% RH or less; No condensation					
Altitude	≤ 2000m					
General specifications						
Weight (host only)	3.3	5.3	7.5	5.5	7.8	Kg
Dimensions (WxHxD)	71x124x418	142x124x418	214x124x418	142x124x418	214x124x418	mm
Cooling	Internal fan forced air cooling					
EMC	Class A test and measurement products in compliance with European EMC Directive 2014/30/EU					
Withstand Voltage	Input to Base: 1500 VAC for 1 minute without abnormality					
	Input to Output: 3000 VAC for 1 minute without abnormality					
	Output to Base: 500 VDC for 1 minute without abnormality					
Insulation Resistance	Input to Base: 500 VDC, ≥100m Ω					
	Input and Output: 500 VDC, ≥ 100m Ω					
	Output to Base: 500 VDC, ≥100m Ω					

Ordering information

Product information		Product No
40V/30A 360W	Single channel programmable Switching DC Power supply	SPS5041X
40V/60A 720W	Single channel programmable Switching DC Power supply	SPS5042X
40V/90A 1080W	Single channel programmable Switching DC Power supply	SPS5043X
40V/30A 360WX2	Dual Channel Programmable Switching DC Power supply	SPS5044X
40V/30A 360WX3	Three Channel Programmable Switching DC Power supply	SPS5045X
50V/10A 180W	Single channel programmable Switching DC Power supply	SPS5051X
80V/15A 360W	Single channel programmable Switching DC Power supply	SPS5081X
80V/30A 720W	Single channel programmable Switching DC Power supply	SPS5082X
80V/45A 1080W	Single channel programmable Switching DC Power supply	SPS5083X
80V/15A 360WX2	Dual Channel Programmable Switching DC Power supply	SPS5084X
80V/15A 360WX3	Three Channel Programmable Switching DC Power supply	SPS5085X
160V/7.5A 360W	Single channel programmable Switching DC Power supply	SPS5161X
160V/15A 720W	Single channel programmable Switching DC Power supply	SPS5162X
160V/22.5A 1080W	Single channel programmable Switching DC Power supply	SPS5163X
160V/7.5A 360WX2	Dual Channel Programmable Switching DC Power supply	SPS5164X
160V/7.5A 360WX3	Three Channel Programmable Switching DC Power supply	SPS5165X
Standard Accessories		
USB Cable -1		
Quick Start -1		
Verification certificate -1		
Power Cord -1		
Output Test Cord 10A -1		
Output guard -1		

Warranty

Three-year warranty, excluding accessories.